

RIGOL



M300 Series Data Acquisition/ Switch System

- Up to 320 switch channels per mainframe, save on cost of ownership
- Can be run without PC
- USB logging
- Interval scanning with storage of up to 100,000 time-stamped readings
- 8 kinds of cards supported
- 6½ digits DMM can be enabled/disabled in any of slots
- Standard SCPI commands
- Math statistics: AVG, MAX, MIN, SDEV
- 4.3" TFT LCD
- Powerful PC software
- Full Interfaces supported: USB Device, USB Host, GPIB, LAN(LXI-Core 2011 Device), RS232

M300 Series Data Acquisition/Switch System with modular structure, which combines precision measurement capability with flexible signal connections, can provide versatile solutions for the applications with multiple points or signals to be tested in product performance test during R&D phase as well as automatic test during production process.

M300 Series Data Acquisition/Switch System

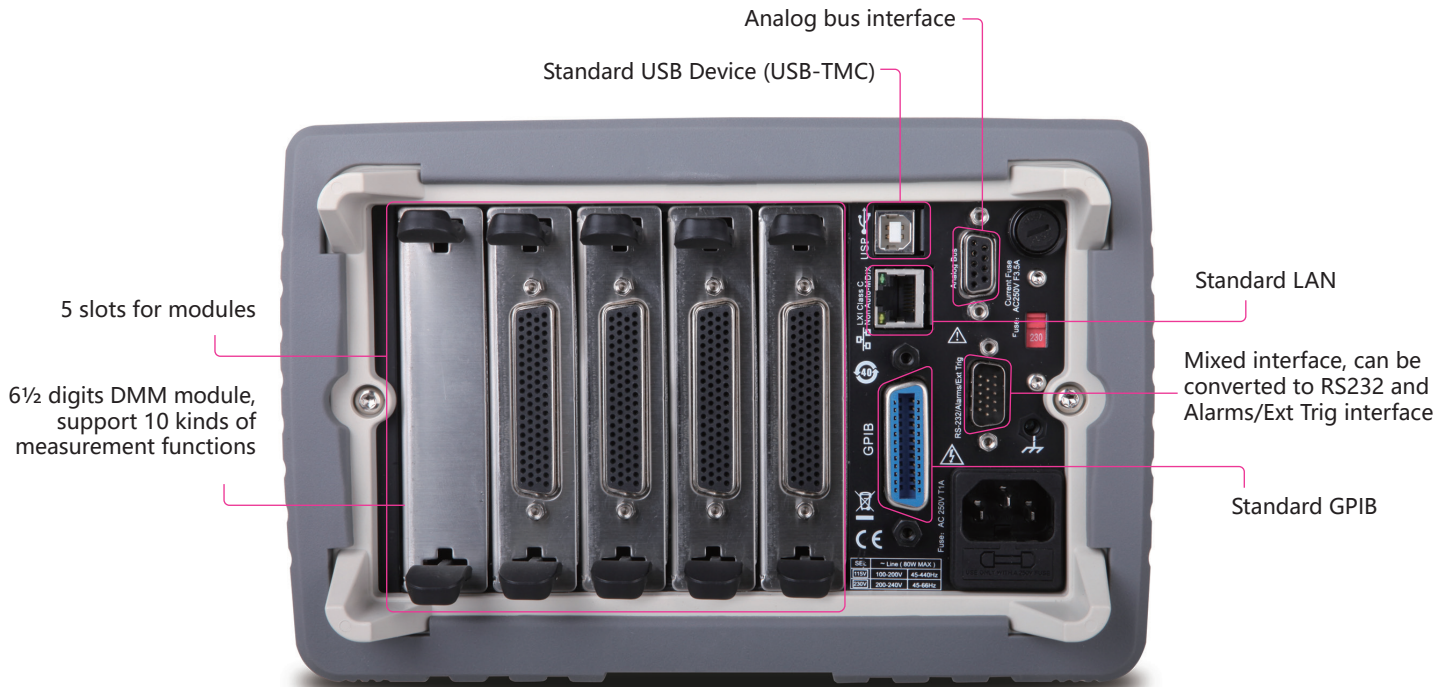
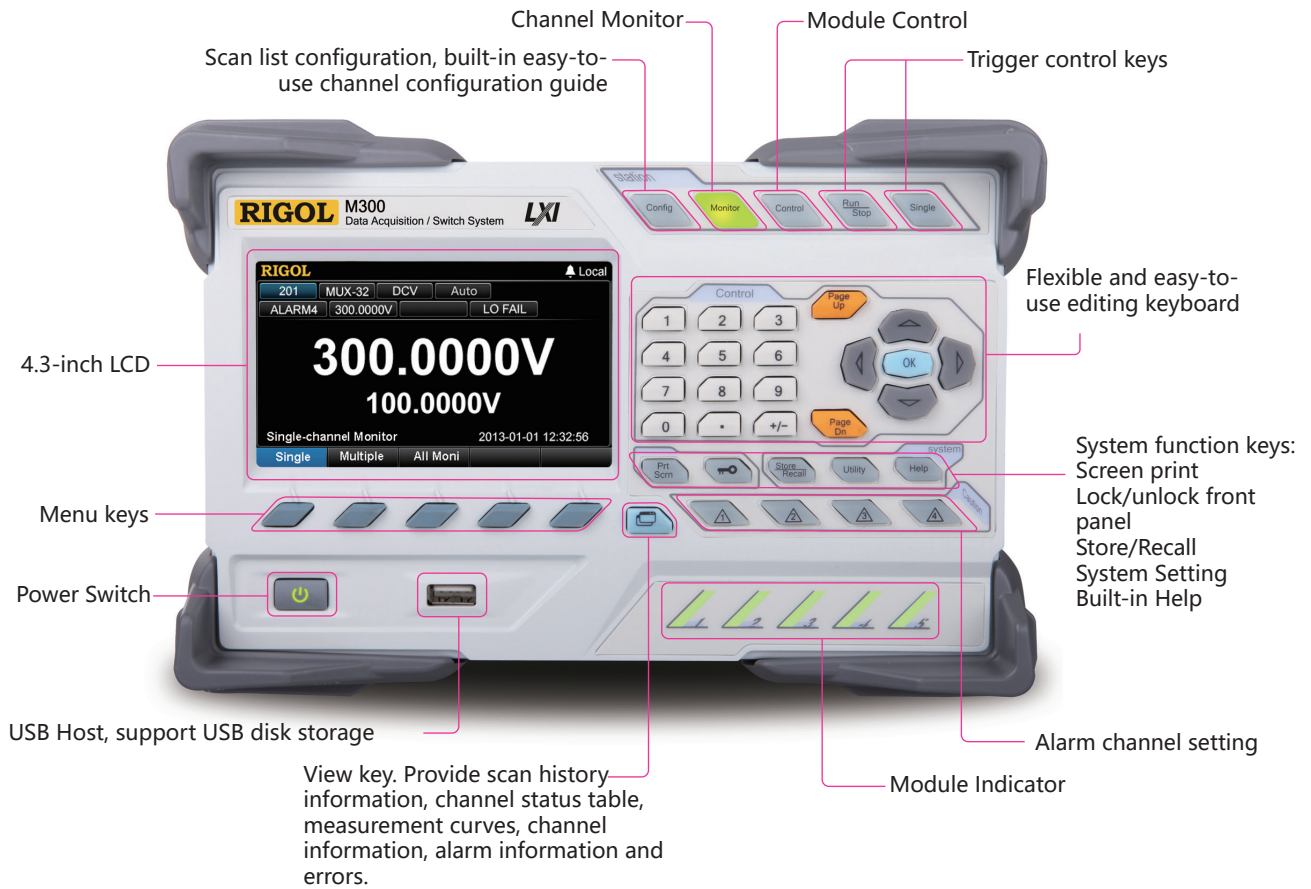

Product Dimensions: Width X Height X Depth=239.0mm×159.0 mm×373.4 mm Weight: 5.7 kg(Without Package)

► Feature and Benefits

·Channel Configuration Guide

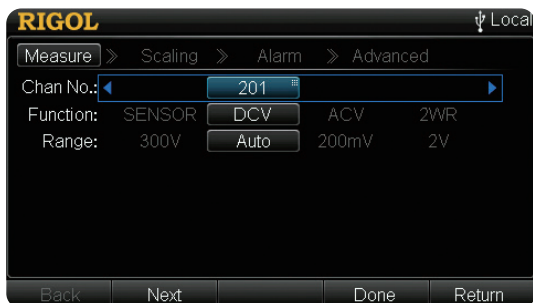

Measurement Configuration

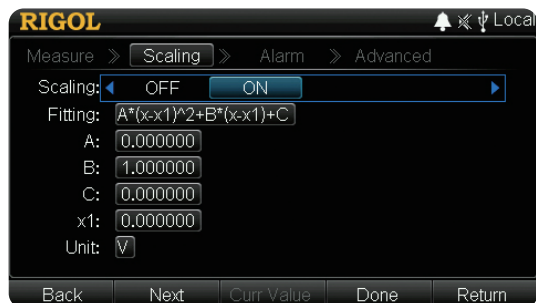

Scaling Configuration

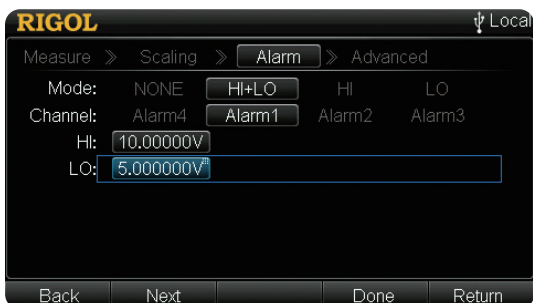

Alarm Configuration



Advanced Configuration

·Channel Monitor

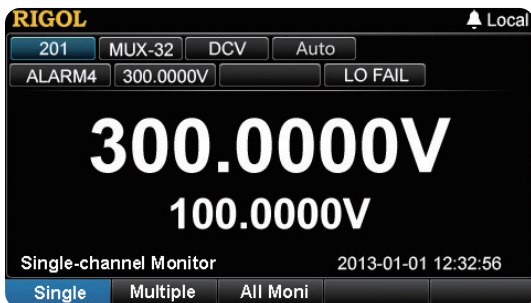

Single Channel Monitor

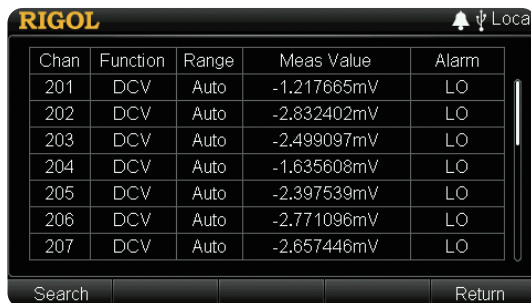

Multiple/All Channel Monitor

·Multi-View Switch



Display real-time scan information and all the measurement data of the channel selected

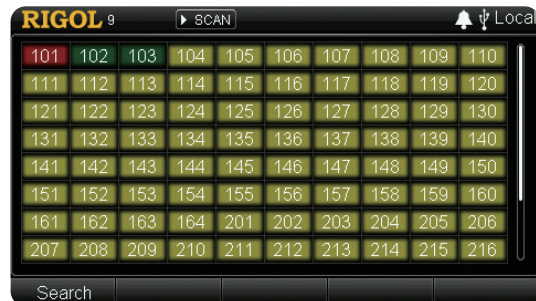

Display real-time channel status

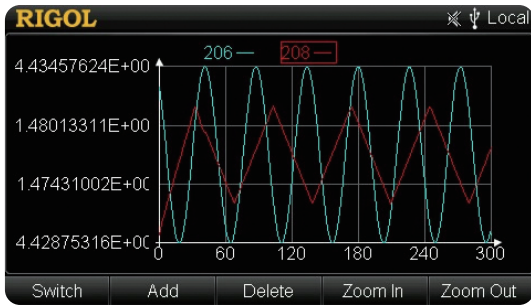

Draw scan data curves

312	2938559Cyc	313	2938539Cyc	314	2938537Cyc
315	2938497Cyc	316	2938496Cyc	317	2938788Cyc
318	2938742Cyc	319	2938746Cyc	320	2938727Cyc
321	2938491Cyc	322	2938471Cyc	323	2938684Cyc
324	2938673Cyc	325	2938465Cyc	326	2938470Cyc
327	2938462Cyc	328	2938459Cyc	329	2938457Cyc
330	2938455Cyc	331	2938452Cyc	332	2938453Cyc
397	1422989Cyc	398	0Cyc	399	1418841Cyc

Record each relay cycle on each module

Alarm Data	Time	Channel	Mode	Alarm
994.0293mV	07-23 14:05:05.000	101	HI	1

Alarm Information

No.	Error Info
1	-113,"Undefined header; keyword cannot be found"
2	-113,"Undefined header; keyword cannot be found"
3	-113,"Undefined header; keyword cannot be found"
4	-102,"Syntax error"

Error Information

Multiple Configuration Copy Functions

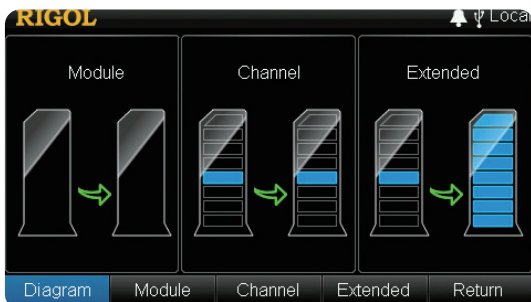

Multiple configuration copy function, can configure multiple channels conveniently and quickly



Module Copy

SourceChan:101	TargetChan: 102								
102	103	104	105	106	107	108	109	110	111
112	113	114	115	116	117	118	119	120	121
122	123	124	125	126	127	128	129	130	131
SourceChan:	TargetChan:101								

Channel Copy



Extended Copy

-To Control Each Module Separately



To control each module separately

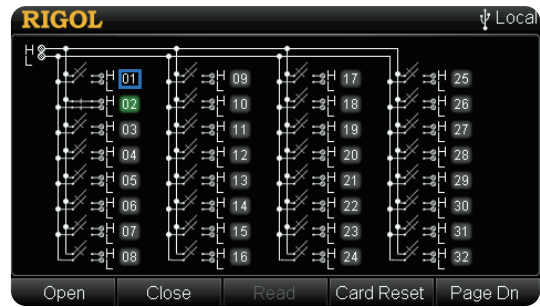

MC3132 Control Interface

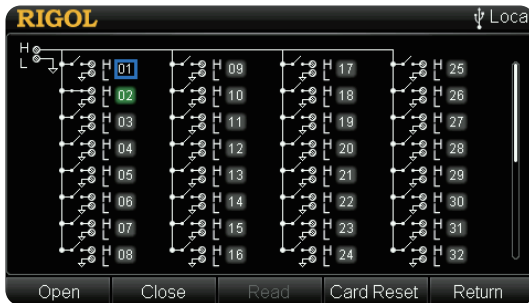

MC3164 Control Interface

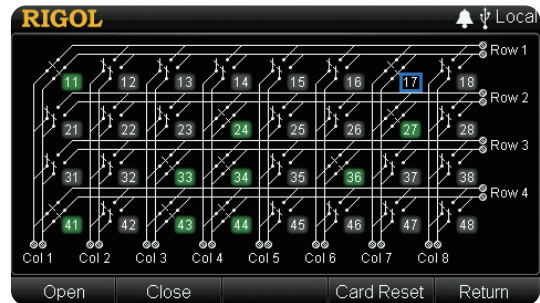

MC3648 Control Interface

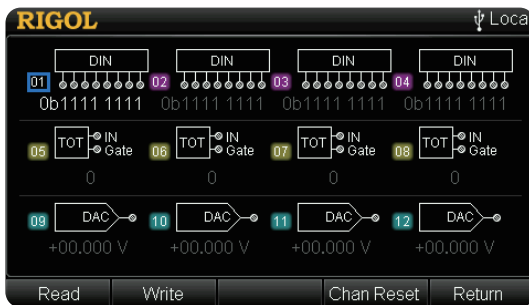

MC3534 Control Interface

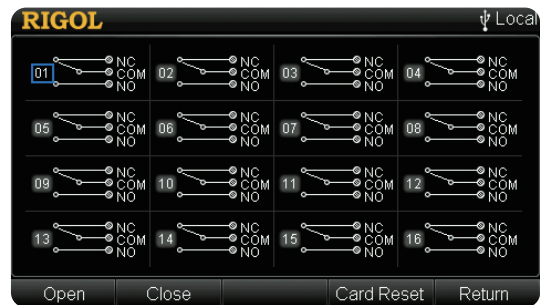

MC3416 Control Interface



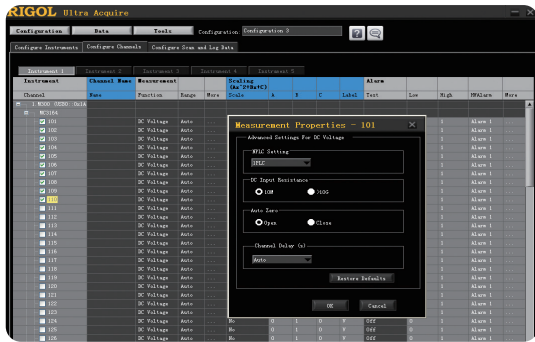



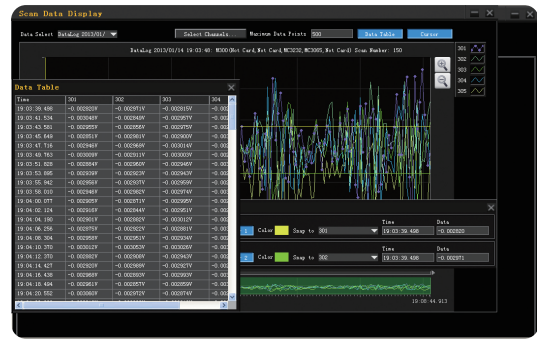

·Channel Configuration of Ultra Acquire







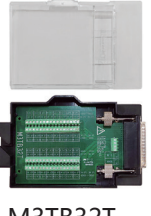
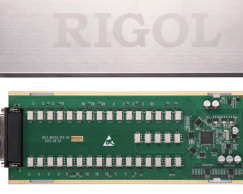



·Data Analysis of Ultra Acquire

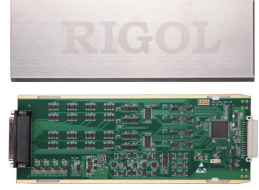

Modules/Terminal Block Supported by M300

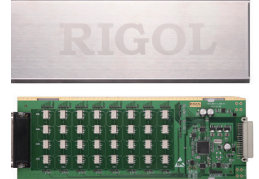
Module	Terminal Block	Description
 DMM-MC3065	MC3065 doesn't need terminal block	<ul style="list-style-type: none"> -DMM module -Used to measure the signal -6½ digits -Support the following functions: DCV, ACV, DCI, ACI,2WR, 4WR, FREQ, PERIOD, TEMP and any sensor -After connecting the DMM module, make sure that the signal under test connected to the analog bus is no greater than 300 Vdc or 300 Vrms
 MUX20-MC3120	 M3TB20	<ul style="list-style-type: none"> -20-channel multiplexer -All 20 channels switch both HI and LO inputs -Support 4-wire measurement -The signal to be tested is connected through the M3TB20 terminal block -Can be connected with MC3065
 MUX32-MC3132	 M3TB32	<ul style="list-style-type: none"> -32-channel multiplexer -All 32 channels switch both HI and LO inputs -Support 4-wire measurement -The signal to be tested is connected through the M3TB32 terminal block -Can be connected with MC3065
 MUX32-MC3132	 M3TB32T	<ul style="list-style-type: none"> -32-channel multiplexer -All 32 channels switch both HI and LO inputs -Support 4-wire measurement -The signal to be tested is connected through the M3TB32T terminal block -Can be connected with MC3065 -Support temperature sensor
 MUX64-MC3164	 M3TB64	<ul style="list-style-type: none"> -64-channel single-ended multiplexer -All 64 channels can switch HI input only -Doesn't support 4-wire measurement -The signal to be tested is connected through the M3TB64 terminal block -Can be connected with MC3065

 <p>MIX24-MC3324</p>	 <p>M3TB24</p>	<ul style="list-style-type: none"> ·Mixed multiplexer with 20 voltage channels and 4 current channels ·All 20 voltage channels switch both HI and LO inputs ·20 voltage channels support 4-wire measurement ·4 current channels are used to measure DC current or AC current ·The signal to be tested is connected through the M3TB24 terminal block ·Can be connected with MC3065
 <p>ACT-MC3416</p>	 <p>M3TB16</p>	<ul style="list-style-type: none"> ·16-channel actuator ·Can connect signal to the device under test or enable external device ·Any of the 16 channels can switch to Normally-Open (NO) and Normally-Closed (NC) states ·The signal is connected through the M3TB16 terminal block
 <p>MFC-MC3534</p>	 <p>M3TB34</p>	<ul style="list-style-type: none"> ·Multifunction module ·DIO: four 8-bit digital input/output ports ·TOT: four totalizer input terminals ·DAC: four analog output terminals ·The signal is connected through the M3TB34 terminal block
 <p>MATRIX-MC3648</p>	 <p>M3TB48</p>	<ul style="list-style-type: none"> ·4×8 two-wire matrix switch ·Used to connect multiple devices to multiple points on the device under test ·32 two-wire cross points which can connect any combination of inputs and outputs at the same time ·The signal is connected through the M3TB48 terminal block

Multiplexers Selection Guide

M300 provides of multiplexers and external terminal blocks which are used to connect signals. You can select your desired multiplexer and terminal block by referring to the following table.

		MC3120	MC3132		MC3164	MC3324
Number of Channels		20	32		64	20+4
		2-wire mode or 4-wire mode	2-wire mode or 4-wire mode		1-wire mode	2-wire mode or 4-wire mode
Scan Speed		60Ch/s	60Ch/s		60Ch/s	60Ch/s
Terminal Block		M3TB20	M3TB32	M3TB32T	M3TB64	M3TB24
DC Voltage		√	√	√	√	√
AC Voltage		√	√	√	√	√
DC Current						√
AC Current						√
2WR		√	√	√	√	√
4WR		√	√	√		√
Frequency		√	√	√	√	√
Period		√	√	√	√	√
Temperature	TC			√		
	RTD			√		
	RTD 4W			√		
	Thermistor			√		
Any Sensor	DC Voltage	√	√	√	√	√
	DC Current					√
	2WR	√	√	√	√	√
	4WR	√	√	√		√
	Frequency	√	√	√	√	√

MC3120 20-Channel Multiplexer

- 20-channel multiplexer
- All 20 channels switch both HI and LO inputs
- Support 2-wire or 4-wire measurement
- The signal to be tested is connected through the M3TB20 terminal block
- Can be connected with MC3065

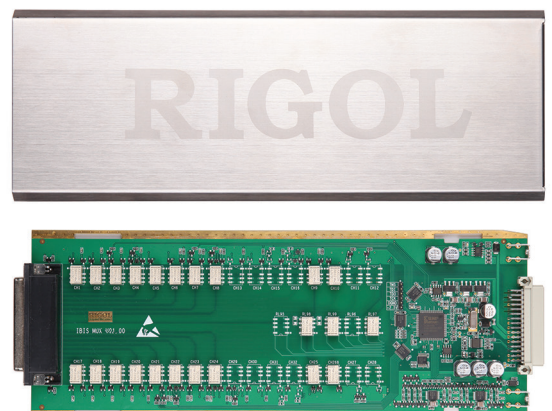
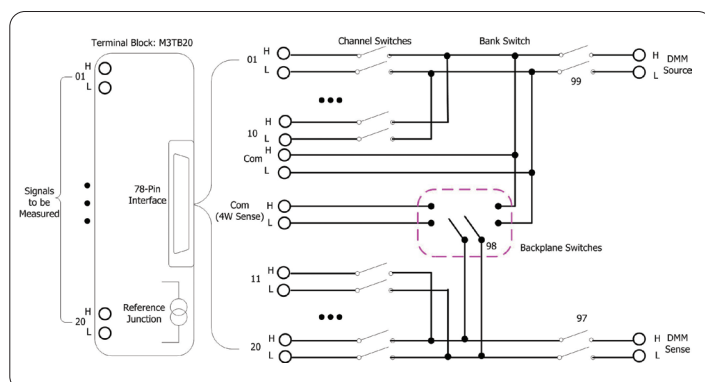

MC3132 32-Channel Multiplexer

- 32-channel multiplexer
- All 32 channels switch both HI and LO inputs
- Support 2-wire or 4-wire measurement
- The signal to be tested is connected through the M3TB32 terminal block
- Can be connected with MC3065

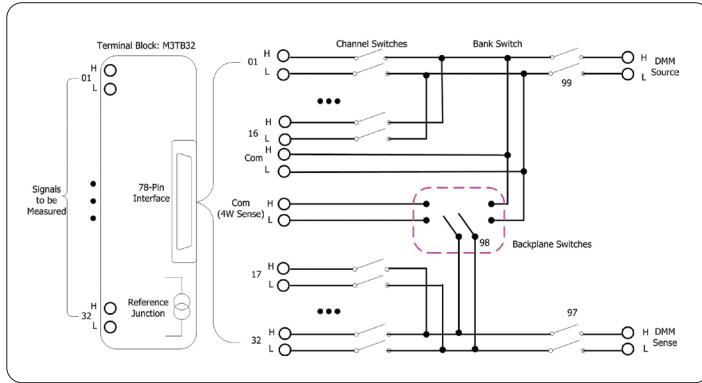

MC3132 32-Channel Multiplexer

- 32-channel multiplexer
- All 32 channels switch both HI and LO inputs
- Support 2-wire or 4-wire measurement
- The signal to be tested is connected through the M3TB32T terminal block
- Can be connected with MC3065
- Support temperature sensor

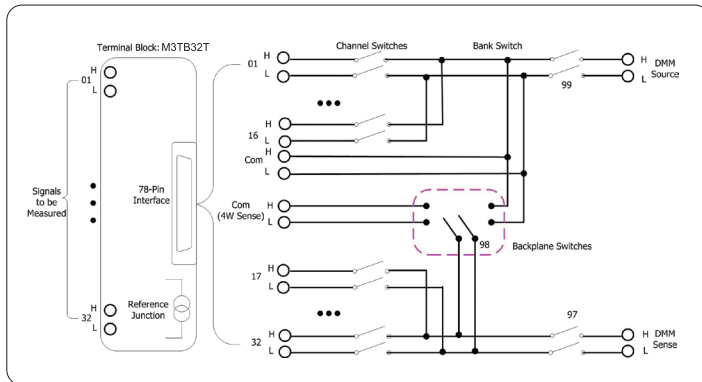

MC3164 64-Channel Single-ended Multiplexer

- 64-channel single-ended multiplexer
- All 64 channels can switch HI input only
- Doesn't support 4-wire measurement
- The signal to be tested is connected through the M3TB64 terminal block
- Can be connected with MC3065

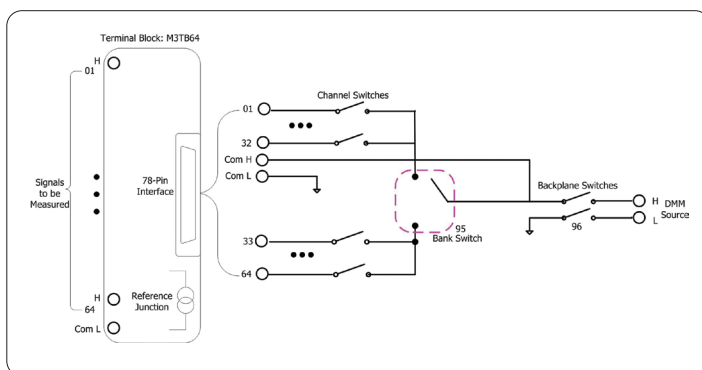

MC3324 20-voltage-channel+4-current-channel Mixed Multiplexer

- Mixed multiplexer with 20 voltage channels and 4 current channels
- All 20 voltage channels switch both HI and LO inputs
- 20 voltage channels support 4-wire measurement
- 4 current channels are used to measure DC current or AC current
- The signal to be tested is connected through the M3TB24 terminal block
- Can be connected with MC3065

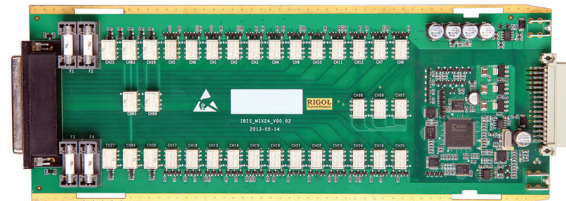
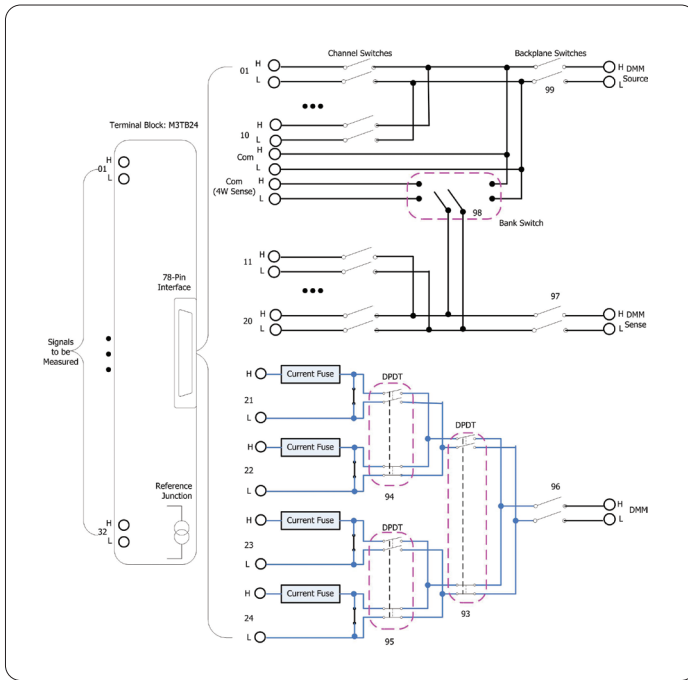

MC3416 16-channel Actuator

- 16-channel actuator
- Can connect signal to the device under test or enable external device
- Any of the 16 channels can switch to Normally-Open (NO) and Normally-Closed (NC) states
- The signal is connected through the M3TB16 terminal block

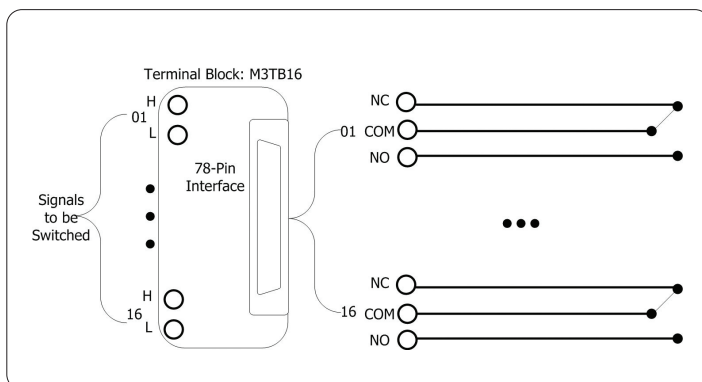
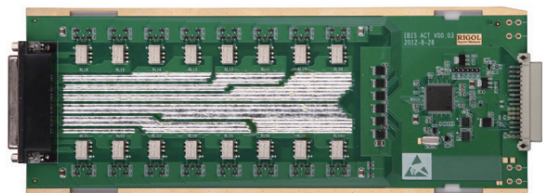

MC3534 Multifunction Module

- Multifunction module
- DIO: four 8-bit digital input/output ports
- TOT: four totalizer input terminals
- DAC: four analog output terminals
- The signal is connected through the M3TB34 terminal block

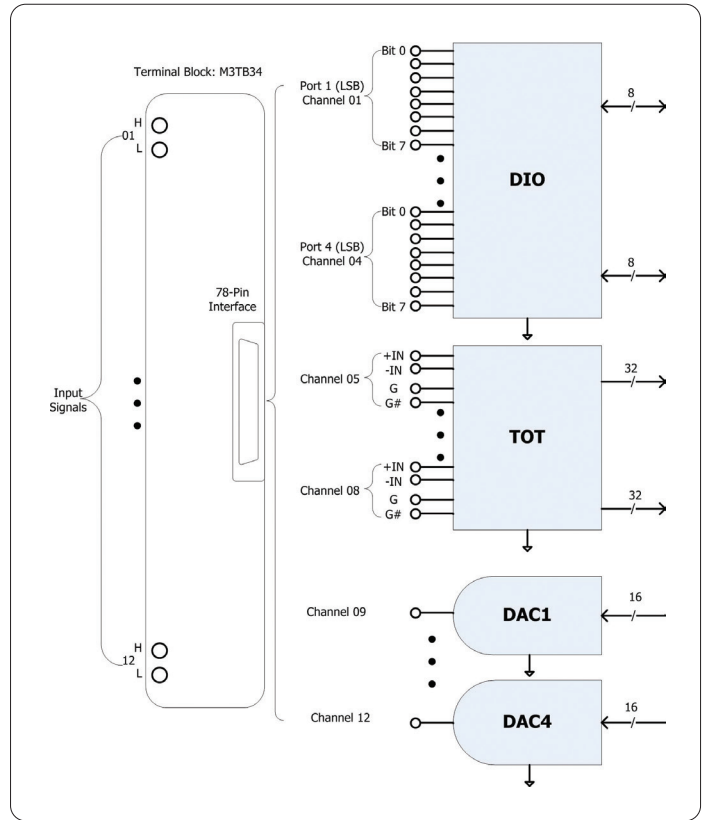

MC3648 4×8 Matrix Switch

- 4×8 two-wire matrix switch
- Used to connect multiple devices to multiple points on the device under test
- 32 two-wire cross points which can connect any combination of inputs and outputs at the same time
- The signal is connected through the M3TB48 terminal block

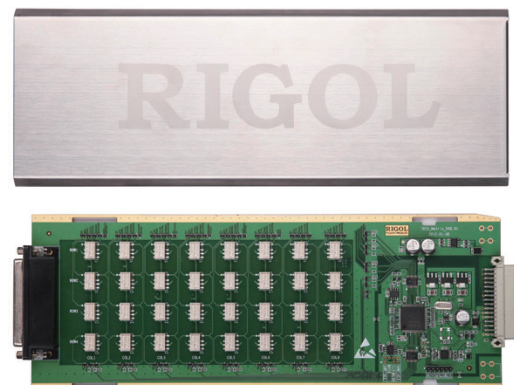
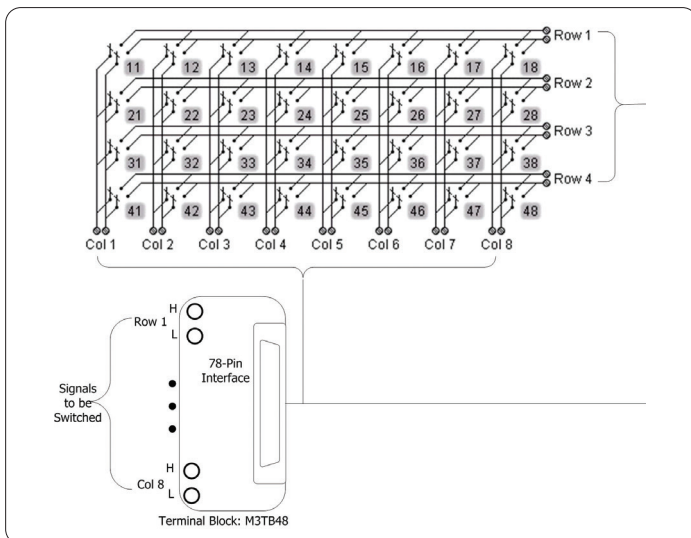

► Specifications

DC Characteristics

Accuracy Specifications: \pm (% of reading + % of range)^[1]

Function	Range ^[2]	Test Current or Load Voltage	24 Hour ^[3] T _{CAL} °C \pm 1°C	90 Day T _{CAL} °C \pm 5°C	1 Year T _{CAL} °C \pm 5°C	Temperature Coefficient 0°C to (T _{CAL} °C -5°C) (T _{CAL} °C +5°C) to 50°C
DC Voltage	200.0000mV	-	0.0020 + 0.0020	0.0030 + 0.0025	0.0040 + 0.0025	0.0005 + 0.0005
	2.000000V	-	0.0015 + 0.0005	0.0020 + 0.0006	0.0035 + 0.0006	0.0005 + 0.0001
	20.00000V	-	0.0020 + 0.0004	0.0030 + 0.0005	0.0040 + 0.0005	0.0005 + 0.0001
	200.0000V	-	0.0020 + 0.0006	0.0040 + 0.0006	0.0050 + 0.0006	0.0005 + 0.0001
	300.000V	-	0.0020 + 0.0006	0.0040 + 0.0010	0.0055 + 0.0010	0.0005 + 0.0001
DC Current	200.0000μA	<0.03V	0.010 + 0.012	0.040 + 0.015	0.050 + 0.015	0.0020 + 0.0030
	2.000000mA	<0.25V	0.007 + 0.003	0.030 + 0.003	0.050 + 0.003	0.0020 + 0.0005
	20.00000mA	<0.07V	0.007 + 0.012	0.030 + 0.015	0.050 + 0.015	0.0020 + 0.0020
	200.0000mA	<0.7V	0.010 + 0.002	0.030 + 0.003	0.050 + 0.003	0.0020 + 0.0005
	1.000000A	<0.12V	0.050 + 0.020	0.080 + 0.020	0.100 + 0.020	0.0050 + 0.0010
Resistance ^[4]	200.0000Ω	1mA	0.0030 + 0.0030	0.008 + 0.004	0.010 + 0.004	0.0006 + 0.0005
	2.000000kΩ	1mA	0.0020 + 0.0005	0.008 + 0.001	0.010 + 0.001	0.0006 + 0.0001
	20.00000kΩ	100μA	0.0020 + 0.0005	0.008 + 0.001	0.010 + 0.001	0.0006 + 0.0001
	200.0000kΩ	10μA	0.0020 + 0.0005	0.008 + 0.001	0.010 + 0.001	0.0006 + 0.0001
	1.000000MΩ	2μA	0.002 + 0.001	0.008 + 0.001	0.012 + 0.001	0.0010 + 0.0002

NOTE: [1] Specifications are for 90-minute warm-up and 100 PLC integration time.

[2] 10% overrange on all ranges.

[3] Relative to calibration standards.

[4] For the basic scenarios of EN 61326-1, use twisted-pair test leads with a pitch of 1 cm and a length of less than 1 m.

Measuring Characteristics

DC Voltage	
Input Impedance	200mV, 2V, 20V ranges: 10MΩ or >10GΩ (For these ranges, input beyond \pm 26 V are clamped through 106 kΩ) 200V and 300V ranges: 10MΩ \pm 1%
Input Protection	300V
Input Offset Current	50pA, at 25°C, typical
CMRR (common mode rejection ratio)	140 dB for 1 kΩ unbalanced resistance in LO lead, \pm 300 VDC peak maximum.
DC Current	
Shunt Resistor	100 Ω for 200 μA, 2 mA 1 Ω for 20 mA, 200 mA 0.1 Ω for 1 A
Resistance	
Measurement Method	4-wire or 2-wire resistance Current source referenced to LO input
Open-circuit Voltage	Limited to <10 V
Max. Lead Resistance (4-wire)	10% of range per lead for 200 Ω and 2 kΩ ranges, 1 kΩ per lead on all other ranges
Input Protection	300V on all ranges
Offset Compensation	Available on 200 Ω, 2 kΩ and 20 kΩ ranges.
Auto Zero OFF Operation (typical value)	
Following instrument warm-up at the environment temperature \pm 1°C and <5 minutes, add 0.0001 % range + 2 μV error for DCV and 2 mΩ error for resistance.	
Settling Considerations	
Reading settling times are affected by source impedance, cable dielectric characteristics and input signal changes. The default measurement delay can ensure the correctness of the first reading for most measurements.	
Measurement Considerations	
Teflon or other high-impedance, low-dielectric absorption wire insulation is recommended for these measurements.	

AC Characteristics

Accuracy Specifications: \pm (% of reading + % of range)^[1]

Function	Range ^[2]	Frequency Range	24 Hour ^[3] $T_{CAL}^{\circ}C \pm 1^{\circ}C$	90 Day $T_{CAL}^{\circ}C \pm 5^{\circ}C$	1 Year $T_{CAL}^{\circ}C \pm 5^{\circ}C$	Temperature Coefficient 0°C to ($T_{CAL}^{\circ}C - 5^{\circ}C$) ($T_{CAL}^{\circ}C + 5^{\circ}C$) to 50°C
True RMS AC Voltage ^[4]	200.0000mV	3Hz- 5Hz	1.00 + 0.03	1.00 + 0.04	1.00 + 0.04	0.100 + 0.004
		5Hz-10Hz	0.35 + 0.03	0.35 + 0.04	0.35 + 0.04	0.035 + 0.004
		10Hz-20kHz	0.04 + 0.03	0.05 + 0.04	0.06 + 0.04	0.005 + 0.004
		20kHz-50kHz	0.10 + 0.05	0.11 + 0.05	0.12 + 0.05	0.011 + 0.005
		50kHz-100kHz	0.55 + 0.08	0.60 + 0.08	0.60 + 0.08	0.060 + 0.008
	2.000000V	100kHz- 300kHz	4.00 + 0.50	4.00 + 0.50	4.00 + 0.50	0.20 + 0.02
		3Hz-5Hz	1.00 + 0.02	1.00 + 0.03	1.00 + 0.03	0.100 + 0.003
		5Hz-10Hz	0.35 + 0.02	0.35 + 0.03	0.35 + 0.03	0.035 + 0.003
		10Hz-20kHz	0.04 + 0.02	0.05 + 0.03	0.06 + 0.03	0.005 + 0.003
		20kHz-50kHz	0.10 + 0.04	0.11 + 0.05	0.12 + 0.05	0.011 + 0.005
	20.00000V	50kHz-100kHz	0.55 + 0.08	0.60 + 0.08	0.60 + 0.08	0.060 + 0.008
		100kHz-300kHz	4.00 + 0.50	4.00 + 0.50	4.00 + 0.50	0.20 + 0.02
		3Hz-5Hz	1.00 + 0.03	1.00 + 0.04	1.00 + 0.04	0.100 + 0.004
		5Hz-10Hz	0.35 + 0.03	0.35 + 0.04	0.35 + 0.04	0.035 + 0.004
		10Hz-20kHz	0.04 + 0.04	0.07 + 0.04	0.08 + 0.04	0.008 + 0.004
	200.0000V	20kHz- 50kHz	0.10 + 0.05	0.12 + 0.05	0.15 + 0.05	0.012 + 0.005
		50kHz-100kHz	0.55 + 0.08	0.60 + 0.08	0.60 + 0.08	0.060 + 0.008
		100kHz-300kHz	4.00 + 0.50	4.00 + 0.50	4.00 + 0.50	0.20 + 0.02
		3Hz-5Hz	1.00 + 0.02	1.00 + 0.03	1.00 + 0.03	0.100 + 0.003
		5Hz-10Hz	0.35 + 0.02	0.35 + 0.03	0.35 + 0.03	0.035 + 0.003
	300.000V	10Hz-20kHz	0.04 + 0.02	0.07 + 0.03	0.08 + 0.03	0.008 + 0.003
		20kHz-50kHz	0.10 + 0.04	0.12 + 0.05	0.15 + 0.05	0.012 + 0.005
		50kHz-100kHz	0.55 + 0.08	0.60 + 0.08	0.60 + 0.08	0.060 + 0.008
		100kHz-300kHz	4.0 + 0.50	4.0 + 0.50	4.0 + 0.50	0.20 + 0.02
3Hz-5Hz		1.00 + 0.02	1.00 + 0.03	1.00 + 0.03	0.100 + 0.003	
True RMS AC Current ^[5]	200.0000μA	5Hz-10Hz	0.35 + 0.06	0.35 + 0.06	0.35 + 0.06	0.100 + 0.006
		10Hz-5kHz	0.15 + 0.06	0.15 + 0.06	0.15 + 0.06	0.015 + 0.006
		5kHz-10kHz	0.35 + 0.70	0.35 + 0.70	0.35 + 0.70	0.030 + 0.006
		3Hz-5Hz	1.10 + 0.06	1.10 + 0.06	1.10 + 0.06	0.200 + 0.006
	2.000000mA	5Hz-10Hz	0.30 + 0.04	0.30 + 0.04	0.30 + 0.04	0.035 + 0.006
		10Hz-5kHz	0.12 + 0.04	0.12 + 0.04	0.12 + 0.04	0.015 + 0.006
		5kHz-10kHz	0.20 + 0.25	0.20 + 0.25	0.20 + 0.25	0.030 + 0.006
		3Hz-5Hz	1.10 + 0.06	1.10 + 0.06	1.10 + 0.06	0.200 + 0.006
	20.00000mA	5Hz-10Hz	0.35 + 0.06	0.35 + 0.06	0.35 + 0.06	0.100 + 0.006
		10Hz-5kHz	0.15 + 0.06	0.15 + 0.06	0.15 + 0.06	0.015 + 0.006
		5kHz-10kHz	0.35 + 0.70	0.35 + 0.70	0.35 + 0.70	0.030 + 0.006
	200.0000mA	3Hz-5Hz	1.00 + 0.04	1.00 + 0.04	1.00 + 0.04	0.100 + 0.006
		5Hz-10Hz	0.30 + 0.04	0.30 + 0.04	0.30 + 0.04	0.035 + 0.006
		10Hz-5kHz	0.10 + 0.04	0.10 + 0.04	0.10 + 0.04	0.015 + 0.006
	1.000000A	5kHz-10kHz	0.20 + 0.25	0.20 + 0.25	0.20 + 0.25	0.030 + 0.006
		3Hz-5Hz	1.10 + 0.06	1.10 + 0.06	1.10 + 0.06	0.100 + 0.006
		5Hz-10Hz	0.35 + 0.06	0.35 + 0.06	0.35 + 0.06	0.035 + 0.006
		10Hz-5kHz	0.15 + 0.06	0.15 + 0.06	0.15 + 0.06	0.015 + 0.006
		5kHz-10kHz	0.35 + 0.70	0.35 + 0.70	0.35 + 0.70	0.030 + 0.006
		5Hz-10Hz	0.35 + 0.08	0.35 + 0.10	0.35 + 0.10	0.035 + 0.008
		10Hz-5kHz	0.15 + 0.08	0.15 + 0.10	0.15 + 0.10	0.015 + 0.008

NOTE: [1] Specifications are for 90-minute warm-up, slow ac filter and sine wave input.

[2] 10% overrange on all ranges.

[3] Relative to calibration standards.

[4] Specifications are for sine wave input >5% of range. For inputs from 1% to 5% of range and <50 kHz, add 0.1% of range additional error.

For 50 kHz to 100 kHz, add 0.13% of range.

[5] Specifications are for sine wave input >5% of range. For inputs from 1% to 5% of range, add 0.1% of range additional error.

Specifications are typical values for 200 uA, 2 mA and 1 A ranges when frequency is >1 kHz.

Measuring Characteristics

True RMS AC Voltage	
Measurement Method	AC-coupled True-RMS -- measure the ac component of input with up to 300 V DC bias on any range.
Crest Factor	≤ 5 at full range
Input Impedance	1 MΩ ± 2%, in parallel with <150 pF capacitance on any range
Input Protection	300 V rms on all ranges
AC Filter Bandwidth	Slow: 3 Hz - 300 kHz Medium: 20 Hz - 300 kHz Fast: 200 Hz - 300 kHz
CMRR (common mode rejection ratio)	70 dB, for the 1 kΩ unbalance in LO lead, <60 Hz common mode signal frequency, ±300 VDC peak maximum.
True RMS AC Current	
Measurement Method	Direct coupled to the fuse and shunt; AC-coupled True RMS measurement (measure the AC component).
Crest Factor	≤ 3 at full range
Max. Input	DC + AC current peak value <300% of range. Current with DC current component <1 A rms.
Shunt Resistor	100 Ω for 200 μA, 2 mA 1 Ω for 20 mA, 200 mA 0.1 Ω for 1 A

Settling Time Considerations

The default measurement delay of the multimeter can ensure the correctness of the first readings of most of the measurements. Make sure the RC circuit of input terminal has been fully settled (about 1 s) before accurate measurement.

Frequency and Period Characteristics

Accuracy Specifications: ± (% of reading)^{[1][2]}

Function	Range	Frequency Range	24 Hour ^[3] T _{CAL} °C ±1°C	90 Day T _{CAL} °C ±5°C	1 Year T _{CAL} °C ±5°C	Temperature Coefficient 0°C to (T _{CAL} °C -5°C) (T _{CAL} °C +5°C) to 50°C
Frequency, Period	200mV-300V	3 Hz-5 Hz	0.07	0.07	0.07	0.005
		5 Hz-10 Hz	0.04	0.04	0.04	0.005
		10 Hz-40 Hz	0.02	0.02	0.02	0.001
		40 Hz-300 kHz	0.005	0.006	0.007	0.001
		300 kHz-1 MHz	0.005	0.006	0.007	0.001

Additional Low Frequency Errors: (% of reading)

Frequency	Gate Time (Resolution)			
	1s (0.1ppm)	0.1s (1ppm)	0.01s (10ppm)	0.001s (100ppm)
3 Hz-5Hz	0	0.12	0.12	0.12
5 Hz-10Hz	0	0.17	0.17	0.17
10 Hz-40Hz	0	0.20	0.20	0.20
40 Hz-100Hz	0	0.06	0.21	0.21
100 Hz-300Hz	0	0.03	0.21	0.21
300 Hz-1 kHz	0	0.01	0.07	0.07
>1kHz	0	0	0.02	0.02

NOTE: [1] Specifications are for 90 minutes warm-up and 1 s gate time.

[2] For frequency ≤ 300 kHz, the specification is for AC input voltage of 10% to 110% of range. For frequency >300 kHz, the specification is for AC input voltage of 20% to 110% of range. The maximum input is limited to 750 Vrms or 8 x 10⁷ Volts-Hz (whichever is less). 200 mV range is full range input or input that is larger than the full range.

For 20 mV to 200 mV inputs, multiply % of reading error by 10.

[3] Relative to calibration standards.

Measuring Characteristics

Frequency and Period	
Measurement Method	Reciprocal-counting technique, AC-coupled input using the AC voltage function.
Input Impedance	1 MΩ ± 2%, in parallel with <150 pF capacitance on any range
Input Protection	300 Vrms on all ranges

Measurement Considerations

All frequency counters are susceptible to error when measuring low-voltage, low-frequency signals. Shielding inputs from external noise pickup is critical for minimizing measurement errors.

Settling Considerations

Errors will occur when attempting to measure the frequency or period of an input following a dc offset voltage change. The input blocking RC time constant must be allowed to fully settle (about 1 s) before the most accurate measurements are possible.

Temperature Characteristics

Accuracy Specifications^[1]

Function	Probe Type	Type	Optimum Range	1 Year $T_{CAL}^{\circ}C \pm 5^{\circ}C$	Temperature Coefficient 0°C to ($T_{CAL}^{\circ}C - 5^{\circ}C$) ($T_{CAL}^{\circ}C + 5^{\circ}C$) to 50°C
Temperature	RTD ^[2] (R0 is within 49 Ω and 2.1 kΩ)	$\alpha=0.00385$	-200°C - 660°C	0.16°C	0.01°C
		$\alpha=0.00389$	-200°C - 660°C	0.17°C	0.01°C
		$\alpha=0.00391$	-200°C - 660°C	0.14°C	0.01°C
		$\alpha=0.00392$	-200°C - 660°C	0.15°C	0.01°C
	Thermal Resistance	2.2 kΩ	-40°C - 150°C	0.08°C	0.002°C
		3 kΩ	-40°C - 150°C	0.08°C	0.002°C
		5 kΩ	-40°C - 150°C	0.08°C	0.002°C
	Thermocouple ^[3]	10 kΩ	-40°C - 150°C	0.08°C	0.002°C
		B	0°C - 1820°C	0.76°C	0.14°C
		E	-270°C - 1000°C	0.5°C	0.02°C
		J	-210°C - 1200°C	0.5°C	0.02°C
		K	-270°C - 1372°C	0.5°C	0.03°C
		N	-270°C - 1300°C	0.5°C	0.04°C
R		-50°C - 1768.1°C	0.5°C	0.09°C	
S	-50°C - 1768.1°C	0.6°C	0.11°C		
T	-270°C - 400°C	0.5°C	0.03°C		

NOTE: [1] Specifications are for 90 minutes warm-up. Probe error excluded.

[2] Specification is for 4WR resistance measurement.

[3] Relative to cold junction temperature, accuracy is based on ITS-90. Built-in cold junction temperature refers to the temperature of the connector inside the terminal block and its accuracy is $\pm 2.5^{\circ}C$.

Measuring Characteristics

Thermocouple	
Conversion	ITS-90 software compensation
Reference Junction Type	Internal, Fixed, or External
T/C Check	Selectable per channel. When the channel resistance is $> 5k\Omega$, it is considered as Open.
RTD	
Alpha	= 0.00385 (DIN/IEC 751): using ITS-90 software compensation; = 0.00389, 0.00391 or 0.00392: using IPTS-68 software compensation
Thermistor	
	44004, 44007, 44006 series

Measurement Considerations

The built-in cold junction temperature tracks the temperature inside the terminal box. The change of temperature in the terminal box might cause additional error. When using the built-in cold junction compensation, connect the sensor terminal of the thermocouple to the terminal box and warm it up for more than 3 minutes to minimize the error.

Module Specifications

MC3120/MC3132/MC3164/MC3324/MC3416/MC3648

General	Multiplexer				Actuator	Matrix
	MC3120	MC3132	MC3164	MC3324	MC3416	MC3648
Number of Channels	20	32	64	20 Voltage+4 Current	16	4×8
	2-wire mode or 4-wire mode ^[6]	2-wire mode or 4-wire mode ^[6]	1-wire mode ^[7]	2-wire mode or 4-wire mode ^[8]	SPDT	2-wire mode
Connect to DMM Module?	Yes	Yes	Yes	Yes	No	No
Scanning Speed ^[1]	60Ch/s	60Ch/s	60Ch/s	60Ch/s	—	—
Open/Close Speed	200Ch/s	200Ch/s	200Ch/s	200Ch/s	200Ch/s	200Ch/s
Maximum Input						
Voltage (DC, AC rms)	300Vrms	300Vrms	300Vrms	300Vrms	300Vrms	300Vrms
Current (DC, AC rms)	1Arms	1Arms	1Arms	1Arms	2Arms	1Arms
Power (W, VA)	50VA	50VA	50VA	50VA	60VA	50VA
Isolation (ch-ch, ch-earth) (DC, AC rms)	300Vrms	300Vrms	300Vrms	300Vrms	300Vrms	300Vrms
DC Characteristics						
Offset Voltage	5uV	5uV	5uV	5uV	<3uV	5uV
Initial Closed Channel Resistance	<1Ω	<1Ω	<1Ω	<1Ω	<0.1Ω	<1Ω
Isolation (ch-ch, ch-earth)	>10GΩ	>10GΩ	>10GΩ	>10GΩ	>10GΩ	>10GΩ
AC Characteristics						
Bandwidth	1MHz	1MHz	1MHz	1MHz	1MHz	1MHz
Ch-Ch Cross Talk (dB) ^[2] 1MHz	-45	-45	-18 ^[3]	-45	- 15	-18
Capacitance HI-LO	100pF	100pF	100pF	100pF	<500pF	100pF
Capacitance LO-Earth	200pF	200pF	200pF	200pF	<200pF	200pF
Volt-Hertz Limit	10 ⁸	10 ⁸	10 ⁸	10 ⁸	10 ⁸	10 ⁸
Other						
T/C Cold Junction Accuracy (Typical)	0.8°C	0.8°C	0.8°C ^[4]	0.8°C	—	—
Switch Life (No Load) (Typical)	100M	100M	100M	100M	100M	100M
Switch Life (Rated Load) (Typical) ^[5]	100K	100K	100K	100K	100K	100K
Operating Temperature	0°C - 55°C	0°C - 55°C	0°C - 55°C	0°C - 55°C	0°C - 55°C	0°C - 55°C
Storage Temperature	-20°C - 70°C	-20°C - 70°C	-20°C - 70°C	-20°C - 70°C	-20°C - 70°C	-20°C - 70°C
Humidity (non-condensing)	40°C / 80% RH	40°C / 80% RH	40°C / 80% RH	40°C / 80% RH	40°C / 80% RH	40°C / 80% RH

NOTE: [1] Integration time: 0.02PLC, channel delay: 0, auto zero: off, alarm: off, scaling: off, data to internal memory (disconnect the communication of the LAN, USB, GPIB or RS232 interface), the results are measured under the DCV function.

[2] 50Ω load.

[3] Isolation within banks is -40dB.

[4] Specifications are for the LO setting and not the temperature of the cold terminal.

[5] Applies to resistive loads only.

[6] The 20-channel multiplexer can be used as 20 two-wire measurement channels or 10 four-wire measurement channels. The 32-channel multiplexer can be used as 32 two-wire measurement channels or 16 four-wire measurement channels.

[7] The 2 groups of channels (32 channels per group) of the 64-channel multiplexer use the same LO terminal.

[8] The 24-channel multiplexer can be used as 20 two-wire measurement channels or 10 four-wire measurement channel and 4 current channels.

MC3534

Digital Input/Output (DIO)					
Port 1,2,3,4	8-bit, input or output, non-isolated				
Type	Vin(L)	Vin(H)	Vout(L)	Vout(H)	Vin(H) Max
TTL	<0.8V	>2.0V	<0.2V@I _{out} =-500mA	>4.8V@I _{out} =1mA	<42V with external open drain pull-up
5V CMOS	<1.5V	>3.5V	<0.2V@I _{out} =-500mA	>4.8V@I _{out} =1mA	
3.3V CMOS	<1.0V	>2.3V	<0.2V@I _{out} =-500mA	>3.15V@I _{out} =1mA	
2.5V CMOS	<0.75V	>1.75V	<0.2V@I _{out} =-500mA	>2.35V@I _{out} =1mA	
User defined	Threshold-0.3V	Threshold+0.3V	<0.2V@I _{out} =-500mA	> (Level - 0.2V) @ I _{out} =1mA	
Alarming	Match or mismatch, maskable				Match or mismatch, maskable
Speed	4ms (Max) alarm sampling				4ms (Max) alarm sampling
Latency	5ms				5ms
Read/Write Speed	100/s				100/s
Totalizer Input (TOT)					
	High Speed (TOT1,TOT2)		Normal Speed (TOT3,TOT4)		
Maximum Count	2 ³² -1		2 ³² -1		
Totalizer Input	10MHz (max), rising or falling edge, programmable		100kHz (max), rising or falling edge, programmable		
Signal Level	CMOS 3.3V,5V tolerable		1Vp-p(min),42Vpk(max), Vcm=-12V~+12V		
Threshold	Fixed at CMOS 3.3V		-12V~+12V, Programmable		
Gated Input	CMOS 3.3V-Hi, CMOS 3.3V-Lo or none, 5V tolerance		CMOS 3.3V-Hi, CMOS 3.3V-Lo or none, 5V tolerance		
Count Reset	Manual or Read + Reset		Manual or Read + Reset		
Read Speed	100/s		100/s		
Analog Voltage Output (DAC)					
DAC 1,2,3,4	±12V, non-isolated (earth referenced)				
Resolution	1mV				
I _{out}	10mA max				
Setting Time	1ms to 0.01 % of output				
Accuracy	±(% of output + mV)				
1 year±5°C	0.25%+20mV				
Temp Coefficient	±(0.015%+1mV)/°C				

General Specifications

Display	4.3 inches
Power Supply	AC 100V - 120V, 45Hz - 440Hz AC 200V - 240V, 45Hz - 66Hz Detect the power frequency automatically at power-on, 400 Hz defaults to 50 Hz
Power Consumption	25 VA Max
Working Environment	Full accuracy for 0°C to 50°C Full accuracy to 80% R.H. at 40°C Non-coagulation
Storage Temperature	-40°C to 70°C
Operation Altitude	Up to 2000 meters
Safety	IEC 61010-1; EN 61010-1; UL 61010-1; CAN/CSA-C22.2 No. 61010-1 Measurement CAT I 300V Pollution Degree 2
EMC	EN 61326-1
Weight	About 5.7 kg (without package)
Dimension	(height × width × length): 159.0mm × 239.0mm × 373.4mm
Remote Interface	GPIB, 10/100Mbit LAN, USB 2.0 Full Speed Device & Host (support USB storage device), RS232
Programming Language	SCPI
LXI Compatibility	LXI Core 2011 Device, Version 1.4
Warm-up Time	90 minutes

► Ordering Information

	Description	Ordering No.
Mainframe	Data Acquisition/Switch System	M300
	Data Acquisition/Switch System + DMM Module	M301
	Data Acquisition/Switch System + DMM Module+MC3120 20-Channel Multiplexer	M302
Standard Accessories	Power Cord Conforming to the Standard of the Country	-
	USB Cable	CB-USBA-USBB-FF-150
	Mixed-interface Separator Line	MIX-SEPARATOR
	M300 Series Standard Control and Data Analysis PC Software	Ultra Acquire
	Four Spare Fuses: 2 AC, 250 V, T3.15 A fuses 2 AC, 250 V, T250 mA fuses	-
Optional Accessories: Module	DMM Module (6½ digits)	MC3065
	20-Channel Multiplexer	MC3120
	32-Channel Multiplexer	MC3132
	64-Channel Single-ended Multiplexer	MC3164
	20-Voltage-Channel+4-Current-Channel Mixed Multiplexer	MC3324
	16-Channel Actuator	MC3416
	Multifunction Module	MC3534
	4×8 Matrix Switch	MC3648
Optional Accessories: Terminal block	MC3120 Terminal Block	M3TB20
	MC3132 Terminal Block	M3TB32
	MC3132 Terminal Block	M3TB32T
	MC3164 Terminal Block	M3TB64
	MC3324 Terminal Block	M3TB24
	MC3648 Terminal Block	M3TB48
	MC3534 Terminal Block	M3TB34
	MC3416 Terminal Block	M3TB16
Optional Accessories	RS232 Cable	-
	External Port for Analog Bus	A-BUS-EXT-PORT
	SMB-BNC Cables	SMB-BNC
	Rack Mount Kit	RM-1-M300
	Rack Mount Kit for Two Instruments	RM-2-M300
	M300 Series Control and Advanced Data Analysis PC Software	Ultra Acquire Pro

Boost Smart World and Technology Innovation

Industrial Intelligent
Manufacturing



Semiconductors

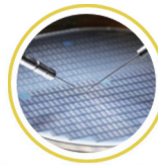

Education &
Research

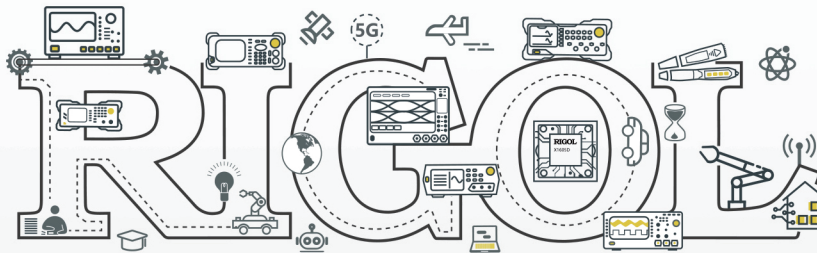

Communication

System Integration

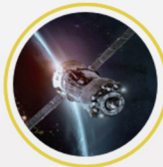

New Energy



- Cellular-5G/WIFI
- UWB/RFID/ ZIGBEE
- Digital Bus/Ethernet
- Optical Communication

- Digital/Analog/RF Chip
- Memory and MCU Chip
- Third-Generation Semiconductor
- Solar Photovoltaic Cells

- New Energy Automobile
- PV/Inverter
- Power Test
- Automotive Electronics

*Provide Testing and Measuring Products
and Solutions for Industry Customers*

HEADQUARTER

RIGOL TECHNOLOGIES CO., LTD.
No.8 Keling Road, New District,
Suzhou, JiangSu, P.R.China
Tel: +86-400620002
Email: info-cn@rigol.com

JAPAN

RIGOL JAPAN CO., LTD.
5F, 3-45-6, Minamitsuka, Toshima-Ku,
Tokyo, 170-0005, Japan
Tel: +81-3-6262-8932
Fax: +81-3-6262-8933
Email: info.jp@rigol.com

EUROPE

RIGOL TECHNOLOGIES EU GmbH
Carl-Benz-Str.11
82205 Gilching
Germany
Tel: +49(0)8105-27292-0
Email: info-europe@rigol.com

KOREA

RIGOL KOREA CO., LTD.
5F, 222, Gonghang-daero,
Gangseo-gu, Seoul, Republic of Korea
Tel: +82-2-6953-4466
Fax: +82-2-6953-4422
Email: info.kr@rigol.com

NORTH AMERICA

RIGOL TECHNOLOGIES, USA INC.
10220 SW Nimbus Ave.
Suite K-7
Portland, OR 97223
Tel: +1-877-4-**RIGOL**-1
Email: sales@rigol.com

For Assistance in Other Countries

Email: info.int@rigol.com

RIGOL® is the trademark of **RIGOL TECHNOLOGIES CO., LTD.** Product information in this document is subject to update without notice. For the latest information about **RIGOL's** products, applications and services, please contact local **RIGOL** channel partners or access **RIGOL** official website: www.rigol.com

DSC07105-5110 2026-03