



**RIGOL**

# MHO900

## Digital Oscilloscope

User Guide

Sept. 2025



## **Guaranty and Declaration**

### **Copyright**

© 2026 RIGOL TECHNOLOGIES CO., LTD. All Rights Reserved.

### **Trademark Information**

RIGOL® is the trademark of RIGOL TECHNOLOGIES CO., LTD.

### **Notices**

- RIGOL products are covered by P.R.C. and foreign patents, issued and pending.
- RIGOL reserves the right to modify or change parts of or all the specifications and pricing policies at the company's sole decision.
- Information in this publication replaces all previously released materials.
- Information in this publication is subject to change without notice.
- RIGOL shall not be liable for either incidental or consequential losses in connection with the furnishing, use, or performance of this manual, as well as any information contained.
- Any part of this document is forbidden to be copied, photocopied, or rearranged without prior written approval of RIGOL.

### **Product Certification**

RIGOL guarantees that this product conforms to the national and industrial standards in China as well as the ISO9001:2015 standard and the ISO14001:2015 standard. Other international standard conformance certifications are in progress.

### **Contact Us**

If you have any problem or requirement when using our products or this manual, please contact RIGOL.

E-mail: [service@rigol.com](mailto:service@rigol.com)

Website: <http://www.rigol.com>

Section	Description	Page
	List of Figures.....	IX
	List of Tables.....	XV
1	Safety Requirement .....	1
1.1	General Safety Summary .....	1
1.2	Safety Notices and Symbols .....	3
1.3	Measurement Category .....	3
1.4	Ventilation Requirement .....	4
1.5	Working Environment .....	4
1.6	Care and Cleaning .....	6
1.7	Environmental Considerations .....	6
2	Product Features .....	8
3	Document Overview .....	9
4	Quick Start .....	11
4.1	General Inspection .....	11
4.2	Appearance and Dimensions .....	11
4.3	To Prepare for Use .....	12
4.3.1	To Adjust the Supporting Legs .....	12
4.3.2	To Connect to AC Power .....	13
4.3.3	Turn-on Checkout .....	13
4.3.4	To Set the System Language .....	15
4.3.5	To Connect the Probe .....	15
4.3.6	Function Inspection .....	17
4.3.7	Probe Compensation .....	19
4.4	Product Overview .....	19
4.4.1	Front Panel .....	20
4.4.2	Rear Panel .....	26
4.4.3	User Interface .....	28
4.5	Touch Screen Gestures .....	30
4.5.1	Tap .....	31
4.5.2	Drag .....	31
4.5.3	Pinch&Stretch .....	32
4.6	Parameter Setting Method .....	32
4.7	To Use the Security Lock .....	38

4.8 To Use the Built-in Help System .....	38
<b>5 Vertical System .....</b>	<b>40</b>
5.1 To Enable or Disable the Analog Channel .....	40
5.2 To Adjust the Vertical Scale .....	42
5.3 To Adjust the Vertical Offset .....	43
5.4 To Specify the Channel Coupling .....	44
5.5 To Specify the Bandwidth Limit .....	45
5.6 To Specify the Input Impedance .....	45
5.7 To Invert a Waveform .....	46
5.8 To Set the Probe .....	47
5.9 To Specify the Amplitude Unit .....	49
5.10 Bias .....	49
5.11 To Specify the Skew .....	50
5.12 To Turn the Channel Label Display On/Off .....	50
<b>6 Horizontal System .....</b>	<b>52</b>
6.1 To Adjust the Horizontal Time Base .....	52
6.2 To Adjust the Horizontal Position .....	53
6.3 Zoom Mode (Delayed Sweep) .....	54
<b>7 Acquisition System .....</b>	<b>57</b>
7.1 Acquisition Mode .....	57
7.2 Sampling Mode .....	58
7.3 Sample Rate .....	59
7.4 Memory Depth .....	60
7.5 Horizontal Expansion Reference .....	62
7.6 Roll Mode .....	62
7.7 XY Mode .....	63
<b>8 To Trigger the Oscilloscope .....</b>	<b>66</b>
8.1 Trigger Source .....	66
8.2 Trigger Level .....	67
8.3 Trigger Mode .....	67
8.4 Trigger Coupling .....	69
8.5 Trigger Holdoff .....	69
8.6 Noise Rejection .....	70
8.7 Trigger Type .....	70
8.7.1 Edge Trigger .....	71
8.7.2 Pulse Width Trigger .....	72
8.7.3 Slope Trigger .....	74

8.7.4	Video Trigger	77
8.7.5	Pattern Trigger	80
8.7.6	Duration Trigger	82
8.7.7	Timeout Trigger	84
8.7.8	Runt Trigger	86
8.7.9	Window Trigger	88
8.7.10	Delay Trigger	90
8.7.11	Setup/Hold Trigger	93
8.7.12	Nth Edge Trigger	95
8.7.13	RS232 Trigger	97
8.7.14	I2C Trigger	99
8.7.15	SPI Trigger	103
8.7.16	CAN Trigger	106
8.7.17	LIN Trigger	109
8.7.18	FlexRay Trigger (Option)	111
8.7.19	I2S Trigger (Option)	114
8.7.20	MIL-STD-1553 Trigger (Option)	118
8.8	Trigger Output Connector	121
9	Math Operation	122
9.1	Arithmetic Operation	124
9.2	Function Operation	127
9.3	FFT Operation	131
9.4	Logic Operation	137
9.5	Digital Filter	140
10	Measurements	145
10.1	Auto Scale	145
10.2	Auto Measurements	146
10.2.1	Measurement Parameter	146
10.2.1.1	Time Parameters	146
10.2.1.2	Count Values	147
10.2.1.3	Delay and Phase Parameters	149
10.2.1.4	Voltage Parameters	151
10.2.1.5	Other Parameters	152
10.2.2	Select the Measurement Item	153
10.2.3	Measurement Settings	155
10.2.4	Remove the Measurement Results	158
10.3	Cursor Measurements	159

10.3.1	Manual Mode	161
10.3.2	Track Mode	162
10.3.3	XY Mode	165
<b>11</b>	<b>Digital Voltmeter (DVM) and Frequency Counter</b>	<b>167</b>
11.1	Digital Voltmeter (DVM)	167
11.1.1	Measurement Settings	167
11.1.2	Remove the Measurement	169
11.2	Frequency Counter	169
11.2.1	Measurement Settings	170
11.2.2	Reset Statistics	171
11.2.3	Remove the Measurement	171
<b>12</b>	<b>Digital Channel</b>	<b>172</b>
12.1	To Enable or Disable the Digital Channel	173
12.2	To Select the Digital Channel	173
12.3	To Set the Threshold	173
12.4	To Set the Waveform Size	174
12.5	To Set the Order	174
12.6	Probe Calibration	174
12.7	Label Settings	174
<b>13</b>	<b>Histogram Analysis</b>	<b>176</b>
13.1	To Enable or Disable the Histogram Function	176
13.2	To Select the Histogram Type	177
13.3	To Select the Histogram Source	177
13.4	To Set the Histogram Height	177
13.5	To Set the Histogram Range	178
13.6	Histogram Analysis Results	178
13.7	To Export Histogram Data	179
13.8	To Remove Results	179
13.9	To Clear Statistics	180
<b>14</b>	<b>Function/Arbitrary Waveform Generator (Option)</b>	<b>181</b>
14.1	To Output Basic Waveforms	181
14.1.1	Sine	182
14.1.2	Square	184
14.1.3	Ramp	185
14.1.4	Noise	185
14.1.5	DC	185
14.1.6	Exp.Rise	186

14.1.7	Exp.Fall	186
14.1.8	ECG1	186
14.1.9	Gauss	187
14.1.10	Lorentz	187
14.1.11	Haversine	188
14.1.12	Sinc	188
14.1.13	Arbitrary Waveform	189
14.2	Modulation	190
14.2.1	AM	191
14.2.2	FM	193
14.2.3	PM	194
15	Bode Plot (Option)	196
15.1	Basic Setting	197
15.1.1	To Enable or Disable the Bode Plot Function	197
15.1.2	To Start or Stop the Operation	197
15.1.3	To Set the Input/ Output Source	198
15.1.4	To Set the Sweep Signal	198
15.1.5	To Set the Display Type	198
15.1.6	To View the Connection Diagram	200
15.2	Cursors	201
15.3	Amplitude And Frequency Setting	201
15.4	To Save and Load the Bode Plot File	201
16	Reference Waveform	203
16.1	To Enable Ref Function	203
16.2	To Set the Reference Waveform	203
16.3	To Set the Ref Waveform Display	204
16.4	To Export and Import the Reference Waveform	205
17	Pass/Fail Test	207
17.1	To Enable or Disable the Pass/Fail Test Function	208
17.2	To Select the Source	208
17.3	To Set the Test Mask	208
17.4	To Set the Output Form of the Test Results	209
17.5	To Start or Stop the Pass/Fail Test Operation	210
17.6	To Display the Statistics of the Test Results	211
18	Protocol Decoding	212
18.1	Parallel Decoding	212
18.1.1	Clock Setting (CLK)	213

18.1.2	Bus Setting	214
18.1.3	Display-related Settings	216
18.1.4	Event Table	216
18.2	RS232 Decoding	217
18.2.1	Source Setting	219
18.2.2	To Set Data Package	219
18.2.3	Display-related Settings	220
18.2.4	Event Table	221
18.3	I2C Decoding	221
18.3.1	Source Setting	222
18.3.2	Display-related Settings	223
18.3.3	Event Table	224
18.4	SPI Decoding	225
18.4.1	Source Setting	226
18.4.2	To Set the Mode and Data	227
18.4.3	Display-related Settings	228
18.4.4	Event Table	228
18.5	LIN Decoding	229
18.5.1	Signal Configuration	230
18.5.2	Display-related Settings	231
18.5.3	Event Table	231
18.6	CAN Decoding	232
18.6.1	Signal Configuration	233
18.6.2	Display-related Settings	234
18.6.3	Event Table	235
18.7	I2S Decoding(Optional)	236
18.7.1	Source Setting	237
18.7.2	Bus Setting	238
18.7.3	Display-related Settings	238
18.7.4	Event Table	238
18.8	FlexRay Decoding (Option)	239
18.8.1	Signal Configuration	240
18.8.2	Display-related Settings	241
18.8.3	Event Table	241
18.9	1553B Decoding (Option)	243
18.9.1	Source Setting	243
18.9.2	Event Table	244

19	Multi-pane Windowing	246
20	Waveform Recording and Playing	248
20.1	Common Settings	248
20.2	Record Options	250
20.3	Play Options	251
21	Search and Navigation	254
21.1	Search	254
21.2	Navigation	256
22	Display Control	259
22.1	Display Type	259
22.2	Persistence Time	259
22.3	Waveform Intensity	260
22.4	To Set the Screen Grid	260
22.5	Display Settings	260
22.6	Show Scale	261
22.7	Color Grade	261
22.8	Waveform Freeze	261
23	Store and Load	262
23.1	To Enter the Storage Menu	262
23.2	To Save a File	262
23.2.1	To Save the Image	262
23.2.2	To Save the Wave	264
23.2.3	To Save the Setup	265
23.2.4	Binary Data Format (.bin)	267
23.3	To Load a File	270
23.4	Firmware Upgrade	270
23.5	Disk Management	271
23.6	SMB Configuration	273
23.7	To Upload the File via the FTP Server	277
24	System Utility Function Setting	278
24.1	I/O Setting	278
24.2	Basic Settings	280
24.3	About this Oscilloscope	283
24.4	Auto Config	283
24.5	SelfCal	284
24.6	Option List	285
24.7	Quick Operation	285

---

24.8 Self-check .....	287
25 Remote Control .....	289
26 Troubleshooting .....	292
27 Appendix .....	293
27.1 Appendix A: Options and Accessories .....	293
27.2 Appendix B: Warranty .....	294
27.3 Appendix C: Factory Settings .....	294

# List of Figures

Figure 4.1 Front View .....	11
Figure 4.2 Side View .....	12
Figure 4.3 To Adjust the Supporting Legs .....	12
Figure 4.4 Connect to AC Power .....	13
Figure 4.5 Connect the Passive Probe .....	16
Figure 4.6 Connect the Logic Probe .....	17
Figure 4.7 Use the Compensation Signal .....	18
Figure 4.8 Square Waveform Signal .....	18
Figure 4.9 Probe Compensation .....	19
Figure 4.10 Front Panel .....	20
Figure 4.11 Rear Panel .....	26
Figure 4.12 User Interface .....	28
Figure 4.13 Tap Gesture .....	31
Figure 4.14 Drag Gesture .....	32
Figure 4.15 Pinch&Stretch Gesture .....	32
Figure 4.16 English Input Interface .....	33
Figure 4.17 Chinese Input Interface .....	34
Figure 4.18 String Keypad .....	36
Figure 4.19 Numeric Keypad .....	37
Figure 4.20 Use the Security Lock .....	38
Figure 5.1 Vertical Menu .....	40
Figure 5.2 Switched Input Impedance .....	46
Figure 5.3 Waveform Invert On/Off .....	47
Figure 5.4 Zero Offset .....	50
Figure 6.1 Horizontal Menu .....	52
Figure 6.2 Zoom Mode .....	55
Figure 7.1 Horizontal Menu .....	57

Figure 7.2 Memory Depth .....	61
Figure 7.3 XY Menu .....	64
Figure 7.4 Measurement Schematic Diagram of Phase Deviation .....	64
Figure 8.1 Schematic Diagram of the Acquisition Memory .....	68
Figure 8.2 Trigger Holdoff .....	70
Figure 8.3 Edge Trigger Setting Menu .....	71
Figure 8.4 Positive/Negative Pulse Width .....	72
Figure 8.5 Pulse Width Trigger Setting Menu .....	73
Figure 8.6 Positive Slope Time/Negative Slope Time .....	75
Figure 8.7 Slope Trigger Setting Menu .....	75
Figure 8.8 Video Trigger Setting Menu .....	78
Figure 8.9 Pattern Trigger .....	80
Figure 8.10 Pattern Trigger Setting Menu .....	80
Figure 8.11 Duration Trigger .....	82
Figure 8.12 Duration Trigger Setting Menu .....	83
Figure 8.13 Timeout Trigger .....	85
Figure 8.14 Timeout Trigger Menu .....	85
Figure 8.15 Runt Trigger .....	86
Figure 8.16 Runt Trigger Setting Menu .....	87
Figure 8.17 Window Trigger Setting Menu .....	89
Figure 8.18 Delay Trigger .....	90
Figure 8.19 Delay Trigger Setting Menu .....	91
Figure 8.20 Setup/Hold Trigger .....	93
Figure 8.21 Setup/Hold Trigger Setting Menu .....	94
Figure 8.22 Nth Edge Trigger .....	96
Figure 8.23 Nth Edge Trigger Setting Menu .....	96
Figure 8.24 Schematic Diagram of RS232 Protocol .....	97
Figure 8.25 RS232 Trigger Setting Menu .....	98
Figure 8.26 Sequential Chart of I2C Bus .....	100

Figure 8.27 I2C Trigger Setting Menu .....	100
Figure 8.28 Binary Format Setting .....	102
Figure 8.29 Hex Format Setting .....	102
Figure 8.30 Sequential Chart of SPI Bus .....	103
Figure 8.31 SPI Trigger Setting Menu .....	104
Figure 8.32 Data Frame Format of the CAN Bus .....	106
Figure 8.33 CAN Trigger Setting Menu .....	106
Figure 8.34 Sample Position .....	108
Figure 8.35 Data Frame Format of the LIN Bus .....	109
Figure 8.36 LIN Trigger Setting Menu .....	109
Figure 8.37 Sample Position .....	110
Figure 8.38 Frame Format of the FlexRay Bus .....	112
Figure 8.39 FlexRay Trigger Setting Menu .....	112
Figure 8.40 Sequential Chart of I2S Bus .....	114
Figure 8.41 I2S Trigger Setting Menu .....	115
Figure 8.42 Formats of the Command Word, Data Word, and Status Word of the 1553B Bus .....	118
Figure 8.43 MIL-STD-1553 Trigger Setting Menu .....	119
Figure 9.1 Math Menu .....	123
Figure 9.2 Waveform Display Window of the Operation Results .....	123
Figure 9.3 Arithmetic Operation Menu .....	125
Figure 9.4 Operation Result Display Window .....	125
Figure 9.5 Function Operation Menu .....	128
Figure 9.6 Operation Result Display Window .....	129
Figure 9.7 FFT Operation Menu .....	132
Figure 9.8 FFT Operation Window .....	132
Figure 9.9 Peak Search .....	136
Figure 9.10 Peak Points Display Window .....	137
Figure 9.11 Logic Operation Menu .....	137

Figure 9.12 Operation Result Display Window .....	139
Figure 9.13 Digital Filter Menu .....	141
Figure 9.14 Operation Result Display Window .....	142
Figure 10.1 Time Parameters .....	146
Figure 10.2 Delay and Phase Parameters .....	149
Figure 10.3 Voltage Parameters .....	151
Figure 10.4 Vertical Measurement Items .....	153
Figure 10.5 Horizontal Measurement Items .....	154
Figure 10.6 Other Measurement Items .....	154
Figure 10.7 Measurement Settings Menu .....	155
Figure 10.8 Cursors .....	159
Figure 10.9 Manual Cursor Measurement Example .....	162
Figure 10.10 Track Measurement (before Horizontal Expansion) .....	164
Figure 10.11 Track Measurement (after Horizontal Expansion) .....	164
Figure 10.12 XY Mode Setting Menu .....	165
Figure 11.1 DVM Setting Menu .....	168
Figure 11.2 Frequency Counter Setting Menu .....	170
Figure 12.1 LA Menu .....	172
Figure 13.1 Histogram Menu .....	176
Figure 13.2 Histogram Analysis Interface .....	177
Figure 14.1 AFG Setting Menu .....	181
Figure 14.2 Exp.Rise .....	186
Figure 14.3 Exp.Fall .....	186
Figure 14.4 ECG1 .....	187
Figure 14.5 Gauss .....	187
Figure 14.6 Lorentz .....	188
Figure 14.7 Haversine .....	188
Figure 14.8 Sinc .....	189
Figure 14.9 Modulation Interface .....	191

Figure 14.10 AM .....	192
Figure 14.11 FM .....	193
Figure 15.1 Bode Plot Setting Menu .....	196
Figure 15.2 Minimized Bode Plot Window .....	197
Figure 15.3 Bode Plot Displayed in Waveform Display Form .....	199
Figure 15.4 Bode Plot Chart Display .....	200
Figure 16.1 Reference Waveform Menu .....	203
Figure 17.1 PassFail Menu .....	207
Figure 17.2 PassFail Menu-Simplified .....	208
Figure 17.3 Pass/Fail Test Interface .....	210
Figure 18.1 Schematic Diagram of Parallel Decoding .....	212
Figure 18.2 Parallel Decoding Menu .....	213
Figure 18.3 Parallel Decoding Event Table .....	217
Figure 18.4 Schematic Diagram of RS232 Serial Bus .....	217
Figure 18.5 RS232 Decoding Menu .....	218
Figure 18.6 RS232 Decoding Event Table .....	221
Figure 18.7 I2C Serial Bus .....	222
Figure 18.8 I2C Decoding Menu .....	222
Figure 18.9 I2C Decoding Event Table .....	224
Figure 18.10 SPI Serial Bus .....	225
Figure 18.11 SPI Decoding Menu .....	226
Figure 18.12 SPI Decoding Event Table .....	229
Figure 18.13 LIN Decoding Menu .....	230
Figure 18.14 LIN Decoding Event Table .....	231
Figure 18.15 CAN Decoding Menu .....	233
Figure 18.16 Sample Position .....	234
Figure 18.17 CAN Decoding Event Table .....	235
Figure 18.18 I2S Decoding Menu .....	236
Figure 18.19 I2S Decoding Event Table .....	239

Figure 18.20 FlexRay Decoding Menu .....	240
Figure 18.21 Sample Position .....	241
Figure 18.22 FlexRay Decoding Event Table .....	242
Figure 18.23 1553B Decoding Menu .....	243
Figure 18.24 1553B Decoding Event Table .....	244
Figure 19.1 Add Window Menu .....	246
Figure 20.1 "Record" Menu .....	248
Figure 20.2 Minimized Window of the Record Operation Interface .....	249
Figure 20.3 Minimized Window of the Play Operation Interface .....	250
Figure 20.4 Minimized Window of the Play Operation Interface .....	251
Figure 21.1 Search Menu .....	254
Figure 21.2 MarkTable Display .....	256
Figure 21.3 Navigation Menu .....	257
Figure 21.4 Simplified Navigation Menu .....	257
Figure 21.5 Search Event Navigation Interface .....	258
Figure 22.1 Display Setting Menu .....	259
Figure 23.1 Image Saving Setting Menu .....	263
Figure 23.2 Waveform Saving Setting Menu .....	264
Figure 23.3 Setup Saving Setting Menu .....	266
Figure 23.4 Load Setting Menu .....	270
Figure 23.5 Upgrade Menu .....	271
Figure 23.6 Disk Management Interface .....	272
Figure 23.7 SMB Setting Menu .....	274
Figure 24.1 Self-calibration Menu .....	285

# List of Tables

Table 4.1 Power Adapter Specification .....	13
Table 5.1 Probe Ratio .....	48
Table 8.1 Video Standard .....	79
Table 9.1 Window Function .....	134
Table 9.2 Logic Operation .....	138
Table 18.1 Bus Setting .....	214
Table 23.1 BIN File Format .....	267
Table 23.2 File Header .....	267
Table 23.3 Waveform Header .....	268
Table 23.4 Waveform Data Header .....	269
Table 27.2 Factory Settings .....	295



# 1 Safety Requirement

---

## 1.1 General Safety Summary

---

Please review the following safety precautions carefully before putting the instrument into operation so as to avoid any personal injury or damage to the instrument and any product connected to it. To prevent potential hazards, please follow the instructions specified in this manual to use the instrument properly.

- **Use Proper Power Cord.**

Only the exclusive power cord designed for the instrument and authorized for use within the destination country could be used.

- **Ground the Product Properly.**

The instrument uses the Type-C power interface. The instrument is not grounded via the power cord. To avoid electric shock, use the ground cable provided in accessories to connect the instrument to the earth ground before connecting any input or output terminals.

- **Make Measurements Properly.**

This product is a non-isolated oscilloscope. The ground (GND) for each input and output interface is not isolated from the metal chassis or the digital interface grounds (such as USB and HDMI). Do not perform floating measurements without using isolated probes, nor connect any port's GND to a port with a voltage difference relative to earth ground. Otherwise, it may cause damage to this product or other devices (such as the DUT or a computer display) connected to the product and can even cause serious personal injury.

- **Connect the Probe Properly.**

If a probe is used, the probe ground lead must be connected to earth ground. Do not connect the ground lead to high voltage. Improper way of connection could result in dangerous voltages being present on the connectors, controls or other surfaces of the oscilloscope and probes, which will cause potential hazards for operators.

- **Observe All Terminal Ratings.**

To avoid fire or shock hazard, observe all ratings and markers on the instrument and check your manual for more information about ratings before connecting the instrument.

- **Use Proper Overvoltage Protection.**

Ensure that no overvoltage (such as that caused by a bolt of lightning) can reach the product. Otherwise, the operator might be exposed to the danger of an electric shock.

- **Do Not Operate Without Covers.**

Do not operate the instrument with covers or panels removed.
- **Do Not Insert Objects into the Air Outlet.**

Do not insert objects into the air outlet, as doing so may cause damage to the instrument.
- **Avoid Circuit or Wire Exposure.**

Do not touch exposed junctions and components when the instrument is powered on.
- **Do Not Operate With Suspected Failures.**

If you suspect that any damage may occur to the instrument, have it inspected by RIGOL authorized personnel before further operations. Any maintenance, adjustment or replacement especially to circuits or accessories must be performed by RIGOL authorized personnel.
- **Provide Adequate Ventilation.**

Inadequate ventilation may cause an increase of temperature in the instrument, which would cause damage to the instrument. So please keep the instrument well ventilated and inspect the air outlet and the fan regularly.
- **Do Not Operate in Wet Conditions.**

To avoid short circuit inside the instrument or electric shock, never operate the instrument in a humid environment.
- **Do Not Operate in an Explosive Atmosphere.**

To avoid personal injuries or damage to the instrument, never operate the instrument in an explosive atmosphere.
- **Keep Instrument Surfaces Clean and Dry.**

To avoid dust or moisture from affecting the performance of the instrument, keep the surfaces of the instrument clean and dry.
- **Prevent Electrostatic Impact.**

Operate the instrument in an electrostatic discharge protective environment to avoid damage induced by static discharges. Always ground both the internal and external conductors of cables to release static before making connections.
- **Use the Battery Properly.**

Do not expose the battery (if available) to high temperature or fire. Keep it out of the reach of children. Improper change of a battery (lithium battery) may cause an explosion. Use the RIGOL specified battery only.
- **Handle with Caution.**

Please handle with care during transportation to avoid damage to keys, knobs, interfaces, and other parts on the panels.

**WARNING**

Equipment meeting Class A requirements may not offer adequate protection to broadcast services within residential environment.

## 1.2 Safety Notices and Symbols

### Safety Notices in this Manual:

**WARNING**

Indicates a potentially hazardous situation or practice which, if not avoided, will result in serious injury or death.

**CAUTION**

Indicates a potentially hazardous situation or practice which, if not avoided, could result in damage to the product or loss of important data.

### Safety Notices on the Product:

- **DANGER**  
It calls attention to an operation, if not correctly performed, could result in injury or hazard immediately.
- **WARNING**  
It calls attention to an operation, if not correctly performed, could result in potential injury or hazard.
- **CAUTION**  
It calls attention to an operation, if not correctly performed, could result in damage to the product or other devices connected to the product.

### Safety Symbols on the Product:



**Hazardous  
Voltage**



**Safety Warning**



**Protective Earth  
Terminal**

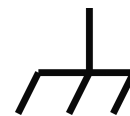

**Chassis Ground**

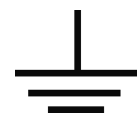

**Test Ground**

## 1.3 Measurement Category

### Measurement Category

This instrument can make measurements in Measurement Category I.

**WARNING**

This instrument can only be used for measurements within its specified measurement categories.

**Measurement Category Definitions**

- **Measurement category I** is for measurements performed on circuits not directly connected to MAINS. Examples are measurements on circuits not derived from MAINS, and specially protected (internal) MAINS derived circuits. In the latter case, transient stresses are variable. Thus, you must know the transient withstand capability of the equipment.
- **Measurement category II** is for measurements performed on circuits directly connected to low voltage installation. Examples are measurements on household appliances, portable tools and similar equipment.
- **Measurement category III** is for measurements performed in the building installation. Examples are measurements on distribution boards, circuit-breakers, wiring (including cables, bus-bars, junction boxes, switches and socket-outlets) in the fixed installation, and equipment for industrial use and some other equipment. For example, stationary motors with permanent connection to a fixed installation.
- **Measurement category IV** is for measurements performed at the source of a low-voltage installation. Examples are electricity meters and measurements on primary overcurrent protection devices and ripple control units.

## 1.4 Ventilation Requirement

This instrument uses a fan to force cooling. Please make sure that the air inlet and outlet areas are free from obstructions and have free air. When using the instrument in a bench-top or rack setting, provide at least 10 cm clearance beside, above and behind the instrument for adequate ventilation.

**CAUTION**

Inadequate ventilation may cause an increase of temperature in the instrument, which would cause damage to the instrument. So please keep the instrument well ventilated and inspect the air outlet and the fan regularly.

## 1.5 Working Environment

**Temperature**

Operating: 0°C to +50°C

Non-operating: -30°C to +60°C

## Humidity

- **Operating:**  
Below +30°C: ≤90%RH (without condensation)  
+30°C to +40°C: ≤75% RH (without condensation)  
+40°C to +50°C: ≤45%RH (without condensation)
- **Non-operating:**  
Below +60°C: ≤90%RH (without condensation)



### WARNING

To avoid short circuit inside the instrument or electric shock, never operate the instrument in a humid environment.

## Altitude

- **Operating:** below 3 km
- **Non-operating:** below 15 km

## Protection Level Against Electric Shock

ESD ±8kV

## Installation (Overvoltage) Category

This product is powered by mains conforming to installation (overvoltage) category II.



### WARNING

Ensure that no overvoltage (such as that caused by a bolt of lightning) can reach the product. Otherwise, the operator might be exposed to the danger of an electric shock.

## Installation (Overvoltage) Category Definitions

Installation (overvoltage) category I refers to signal level which is applicable to equipment measurement terminals connected to the source circuit. Among these terminals, precautions are done to limit the transient voltage to a low level.

Installation (overvoltage) category II refers to the local power distribution level which is applicable to equipment connected to the AC line (AC power).

## Pollution Degree

Pollution Degree 2

## Pollution Degree Definition

- **Pollution Degree 1:** No pollution or only dry, nonconductive pollution occurs. The pollution has no effect. For example, a clean room or air-conditioned office environment.

- **Pollution Degree 2:** Normally only nonconductive pollution occurs. Temporary conductivity caused by condensation is to be expected. For example, indoor environment.
- **Pollution Degree 3:** Conductive pollution or dry nonconductive pollution that becomes conductive due to condensation occurs. To be found in industrial environment or construction sites (harsh environments). For example, sheltered outdoor environment.
- **Pollution Degree 4:** The pollution generates persistent conductivity caused by conductive dust, rain, or snow. For example, outdoor areas.

### Safety Class

Class 2

## 1.6 Care and Cleaning

### Care

Do not store or leave the instrument where it may be exposed to direct sunlight for long periods of time.

### Cleaning

Clean the instrument regularly according to its operating conditions.

1. Disconnect the instrument from all power sources.
2. Clean the external surfaces of the instrument with a soft cloth dampened with mild detergent or water. Avoid having any water or other objects into the chassis via the heat dissipation hole. When cleaning the LCD, take care to avoid scarifying it.



### CAUTION

To avoid damage to the instrument, do not expose it to caustic liquids.



### WARNING

To avoid short-circuit resulting from moisture or personal injuries, ensure that the instrument is completely dry before connecting it to the power supply.

## 1.7 Environmental Considerations

The following symbol indicates that this product complies with the WEEE Directive 2012/19/EU.



The equipment may contain substances that could be harmful to the environment or human health. To avoid the release of such substances into the environment and avoid harm to human health, we recommend you to recycle this product appropriately to ensure that most materials are reused or recycled properly. Please contact your local authorities for disposal or recycling information.

You can click on the following link <https://www.rigol.com/intl/services/environmental-protection-statement.html> to download the latest version of the RoHS&WEEE certification file.

## 2 Product Features

### Product Features

- 12-bit resolution
- Max. 800 MHz analog bandwidth, 4 analog channels
- 16 digital channels, 200 MHz PLA2216 logic analyzer probe (opt.)
- Real-time sample rate: up to 4 GSa/s
- Max. memory depth of 500 Mpts (option)
- Vertical sensitivity 200  $\mu$ V/div to 10 V/div
- Max. waveform capture rate: 1,000,000 wfms/s<sup>[1]</sup>
- Digital phosphor display with real-time 256-level intensity grading
- Optional 2-channel, 50 MHz/100 MHz Function/Arbitrary Waveform Generator (Bode plot supported)
- Supports histogram, digital signal analysis, etc.
- Supports waveform search and navigation function, capable of debugging the signal anomalies faster
- 7" (1024x600) HD touch screen
- Flex knob brings user-friendly experience
- Standard USB2.0 Device & Host, LAN (100M), and HDMI interfaces
- Novel and delicate industrial design, easy to operate
- Supports online upgrade of software version

MHO900 series is RIGOL's new launched economical oscilloscope. Compact in size, it features 1,000,000 wfms/s<sup>[1]</sup> capture rate, max. memory depth of 500 Mpts (option), 12-bit high resolution and low noise.

The product supports 16 digital channels. One instrument can make an analysis on both the analog and digital signals to meet the embedded design and test scenarios. With an affordable price equivalent to purchasing an entry-level instrument, you can access the auto serial and parallel bus analysis, bode plot analysis, and other functions to meet the test demands in the R&D, education, and scientific research fields.

### NOTE

[1]: Single-channel mode, recording mode, 20 ns/div, 1 kpts memory depth (or Auto memory depth).



## 3 Document Overview

This manual gives you a quick review about the front and rear panel of MHO900 series digital oscilloscope, its user interface, and the basic operation method.



### TIP

For the latest version of this manual, download it from the official website of RIGOL (<http://www.rigol.com>).

### Publication Number

UGA46102-1110

### Software Version

00.01.00

Software upgrade might change or add product features. Please acquire the latest version of the manual from RIGOL website or contact RIGOL to upgrade the software.

### Format Conventions in this Manual

#### 1. Key

The front panel key is denoted by the menu key icon. For example,  indicates the "DEFAULT" key.

#### 2. Menu

The menu item is denoted by the format of "Menu Name (Bold) + Character Shading" in the manual. For example, **Setup** indicates clicking or tapping the **Setup** sub-menu under the "Utility" function menu to view the basic setting configuration items.

#### 3. Operation Procedures







The next step of the operation is denoted by ">" in the manual. For example, 

> **Storage** indicates that first clicking or tapping the icon , then clicking or tapping **Storage**.

#### 4. Connector

The connectors on the front or rear panel are denoted by the format of "Connector Name (Bold) + Square Brackets (Bold)". For example, **[AUX OUT]**.

#### 5. Knob

Label	Knob	Label	Knob
<b>Horizontal POSITION</b> 	Horizontal Position Knob		Multifunction Knob 1
<b>Horizontal SCALE</b> 	Horizontal Scale Knob		Multifunction Knob 2
<b>Vertical POSITION</b> 	Channel Vertical Position Knob		Trigger Level Knob
<b>Vertical SCALE</b> 	Channel Vertical Scale Knob	-	-

### Content Conventions in this Manual

MHO900 series digital oscilloscope includes the following models. Unless otherwise specified, this manual takes MHO984 as an example to illustrate the functions and operation methods of MHO900 series oscilloscope.

Model	Max. Analog Bandwidth	No. of Analog Channels
MHO984	800 MHz (single-channel <sup>[1]</sup> & half-channel <sup>[2]</sup> ) 400 MHz (all-channel <sup>[3]</sup> )	4
MHO954	500 MHz (single-channel <sup>[1]</sup> & half-channel <sup>[2]</sup> ) 400 MHz (all-channel <sup>[3]</sup> )	4
MHO934	350 MHz (for any number of channels)	4

### NOTE

**[1]:** Single-channel mode: If any one of the channels is enabled, it is called single-channel mode.

**[2]:** Half-channel mode: If two of the channels are enabled, it is called half-channel.

**[3]:** All-channel mode: If all of the channels are enabled or any three of the channels are enabled, it is called all-channel mode.



## 4 Quick Start

### 4.1 General Inspection

#### 1. Inspect the packaging

If the packaging has been damaged, do not dispose the damaged packaging or cushioning materials until the shipment has been checked for completeness and has passed both electrical and mechanical tests.

The consigner or carrier shall be liable for the damage to the instrument resulting from shipment. RIGOL would not be responsible for free maintenance/rework or replacement of the instrument.

#### 2. Inspect the instrument

In case of any mechanical damage, missing parts, or failure in passing the electrical and mechanical tests, contact your RIGOL sales representative.

#### 3. Check the accessories

Please check the accessories according to the packing lists. If the accessories are damaged or incomplete, please contact your RIGOL sales representative.

#### Recommended Calibration Interval

RIGOL suggests that the instrument should be calibrated every 18 months.

### 4.2 Appearance and Dimensions

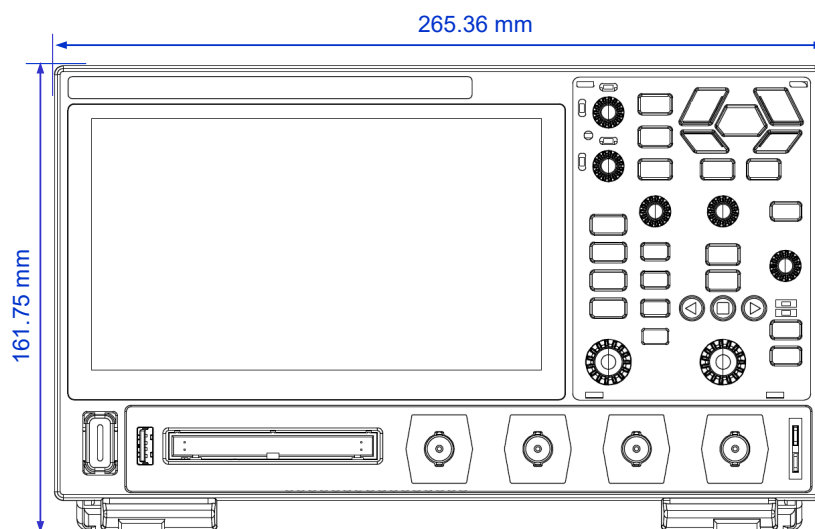

Figure 4.1 Front View

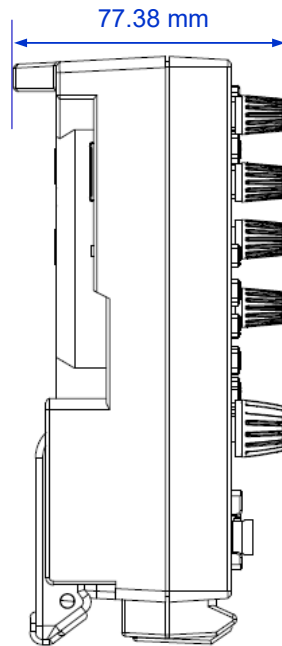

Figure 4.2 Side View

## 4.3 To Prepare for Use

### 4.3.1 To Adjust the Supporting Legs

Adjust the supporting legs properly to use them as stands to tilt the oscilloscope upwards for stable placement of the oscilloscope, making it easy to operate and better to observe waveforms. You can also fold the supporting legs when the instrument is not in use for easier storage or shipment, as shown in the following figure.

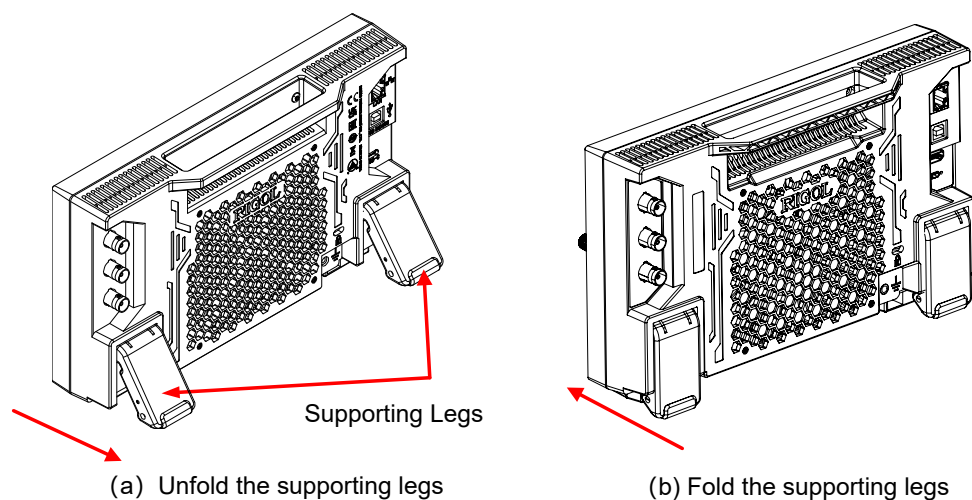

Figure 4.3 To Adjust the Supporting Legs

### 4.3.2 To Connect to AC Power

The power requirements of the oscilloscope are DC, 20 V, 5 A. Please use the power adapter provided in the accessories to connect the oscilloscope to the AC power source (100 V to 240 V, 50 Hz to 60 Hz), as shown in the following figure.

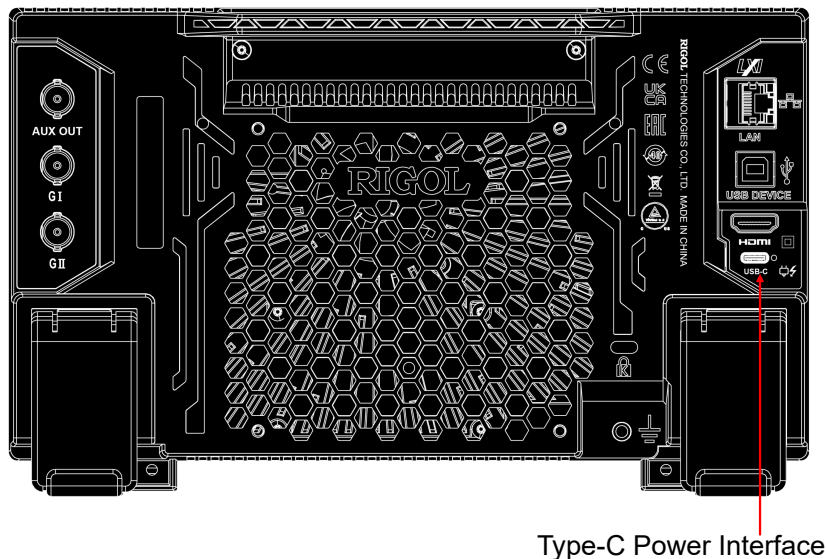

Figure 4.4 Connect to AC Power

Table 4.1 Power Adapter Specification

Parameter	Remarks
Input	100 V to 240 V, 50 Hz to 60 Hz, 1.6 A Max
Output	DC, 20 V, 5 A, 100 W



#### CAUTION

The power adapter provided in the accessories can only be used for RIGOL specified products. Do not use it to charge the mobile phone or other devices.







#### WARNING

To avoid electric shock, use the ground cable provided in the accessories to connect the instrument to the ground properly.

### 4.3.3 Turn-on Checkout

After the instrument is connected to the power source, press the power key  at the lower-left corner of the front panel to power on the instrument. During the start-up

process, the instrument performs a series of self-tests. After the self-test, the splash screen is displayed.

- **Restart:** Click or tap the function navigation icon  at the lower-left corner of the screen to enter the function navigation. Click or tap **Power** > **Restart** to restart the instrument.
- **Shutdown:**
  - Click or tap the function navigation icon  at the lower-left corner of the screen to enter the function navigation. Click or tap **Power** > **Shutdown** to shut down the instrument.
  - Press down the power key , then the power state switching window is displayed. Click or tap **Shutdown** to shut down the instrument.
  - Press the power key  continuously for two times to turn off the instrument.
  - Long press the power key  for three seconds to turn off the instrument.
- **Low Power Mode:**

Click or tap the function navigation icon  at the lower-left corner of the screen to enter the function navigation. Click or tap **Power** > **Low Power Mode** to enter the low power mode.

In the low power mode, the instrument has the following characteristics.

- **It can start quickly with low power consumption.** The instrument can be waken up in just a few seconds. Then it automatically recovers all of its configurations prior to the low power mode.
- **Low power consumption:** In this mode, the screen is off. Most of the measurement hardware (e.g. ADC, front-end amplifier) will be powered off or enter the low power consumption mode. At this time, the power consumption of the instrument is far less than that in its normal operating state.
- **Many ways to wake up the instrument:** To wake up the instrument, press any key on the front panel or rotate the knob. You can also send the SCPI command :SYSTem:LOWPower 0 via the communication interface to wake up the instrument.

#### NOTE

Note that once it enters the low power mode, the last captured waveform data will not be saved when you wake it up from the low mode mode. If necessary, please remember to save the data manually before it enters the low power mode.



**TIP**

You can also click or tap  > **Utility** > **Setup**. Then select "Switch On" for the "Power status" menu. After the instrument is connected to power source, it will start directly.

### 4.3.4 To Set the System Language

---

This oscilloscope supports multiple languages. You can click or tap  > **Utility** > **Setup** > **Language** to select the system language.

### 4.3.5 To Connect the Probe

---

RIGOL's MHO900 series oscilloscope provides the passive probe and the logic analyzer probe (option). For specific probe models, please refer to *MHO900 DataSheet*. For detailed technical information of the probes, please refer to the corresponding Probe User Guide.

**Connect the Passive Probe**

1. Connect the BNC terminal of the probe to the front-panel analog channel input terminal of the oscilloscope, as shown in the figure below.
2. Connect the ground alligator clip or spring of the probe to the circuit ground terminal, and then connect the probe tip to the circuit point to be tested.

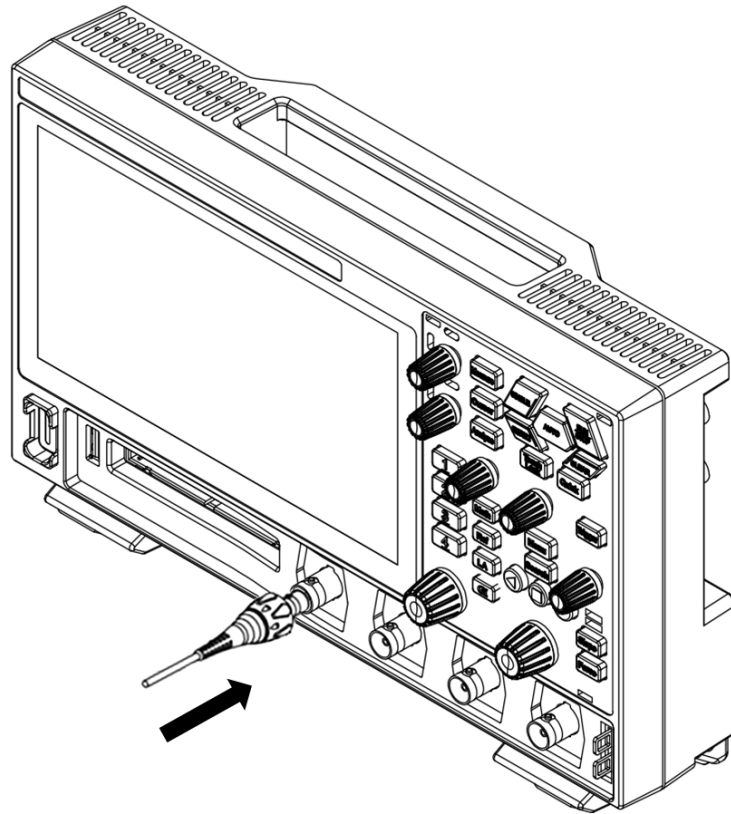

**Figure 4.5 Connect the Passive Probe**

After you connect the passive probe, check the probe function and probe compensation adjustment before making measurements. For detailed procedures, refer to *Function Inspection* and *Probe Compensation*.

### **Connect the Logic Probe**

1. Connect the output terminal of the logic probe to the front-panel digital channel input terminal of the oscilloscope in the correct direction, as shown in the figure below.
2. Connect the input terminal of the logic probe to the signal terminal under test. MHO900 series has an optional configuration of PLA2216 active logic analyzer probe. To apply to different application scenarios, PLA2216 provides two connection methods to connect the signal under test. For details, refer to *PLA2216 Active Logic Probe User Guide*.

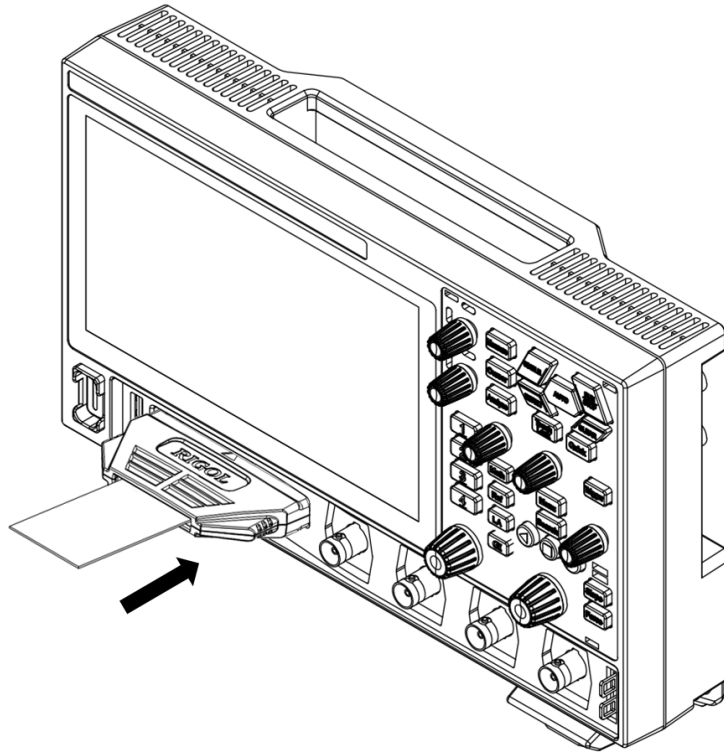

Figure 4.6 Connect the Logic Probe



#### CAUTION

The digital channel input terminal does not support hot plugging. Please do not insert or pull out the logic probe when the instrument is in power-on state.



#### TIP

- For ground connection of high-speed signals, the ground lead shall be connected to the ground test point near the measured signal, and the ground lead shall be kept as short as possible.
- If there are a large number of input signal channels, please connect each signal to a ground signal as far as possible. If there is only one ground test point, connect all ground leads on the probe to the ground test point.
- Set a proper threshold value for the logic probe according to the actual level range of the signal under test. Set the threshold value to the middle of the level range.

### 4.3.6 Function Inspection

1. Press  on the front panel, then a prompt message displaying "Restore default settings?" appears on the screen. Click **OK** to restore the instrument to its factory default settings.
2. Connect the ground alligator clip of the probe to the "Ground Terminal" as shown in [Figure 4.7](#) below.

- Use the probe to connect the input terminal of CH1 of the oscilloscope and "Compensation Signal Output Terminal" shown in *Figure 4.7*.

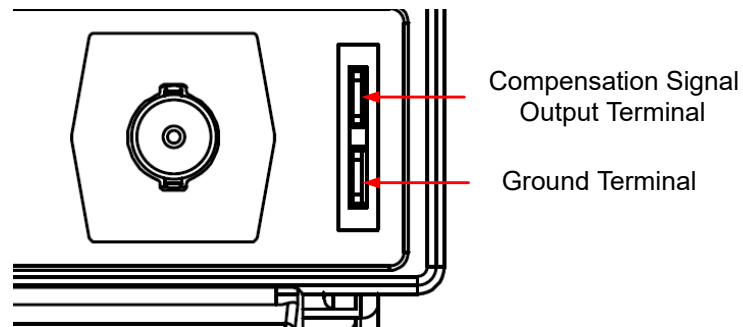

**Figure 4.7 Use the Compensation Signal**

- Set the probe ratio based on the attenuation of the probe, and then click  > **Auto**.
- Observe the waveform on the display. In normal condition, the square waveform as shown in the figure below should be displayed.



**Figure 4.8 Square Waveform Signal**

- Use the same method to test the other channels. If the signal appears but not properly displayed or deformed, please perform the instructions specified in *Probe Compensation*. If no signal appears, please perform the above steps again.



#### **WARNING**

To avoid electric shock when using the probe, please make sure that the insulated wire of the probe is in good condition. Do not touch the metallic part of the probe when the probe is connected to high voltage source.

### 4.3.7 Probe Compensation

When used for the first time, the oscilloscope probe must be compensated to match the input characteristics of the oscilloscope channel to which it is connected. The non-compensated or poorly compensated probe may cause measurement errors. The compensation procedure is as follows:

1. Perform Step 1, 2, 3 and 4 in **Function Inspection**.
2. Check the displayed waveforms and compare them with the waveforms shown in

*Figure 4.9.*

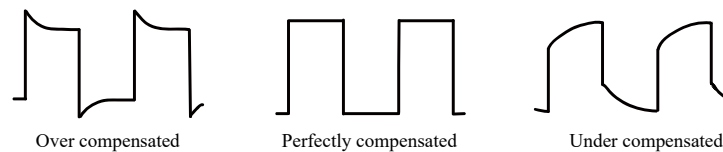

**Figure 4.9 Probe Compensation**

3. Use the probe compensation adjustment tool provided in the accessories to adjust the low-frequency compensation adjustment hole on the probe until the displayed waveform is consistent with the "Perfectly compensated" waveform shown in the above figure.

## 4.4 Product Overview

MHO900 series is RIGOL's new launched economical oscilloscope. Compact in size, it features 1,000,000 wfms/s<sup>[1]</sup> capture rate (in fast recording mode), up to 500 Mpts memory depth (option), 12-bit high resolution and low noise.

Unless otherwise specified, this section takes MHO984 as an example to introduce the appearance dimensions, front and rear panel, and user interface of the series oscilloscope.

#### NOTE

[1]: Single-channel mode, recording mode, 20 ns/div, 1 kpts memory depth (or Auto memory depth).



### 4.4.1 Front Panel

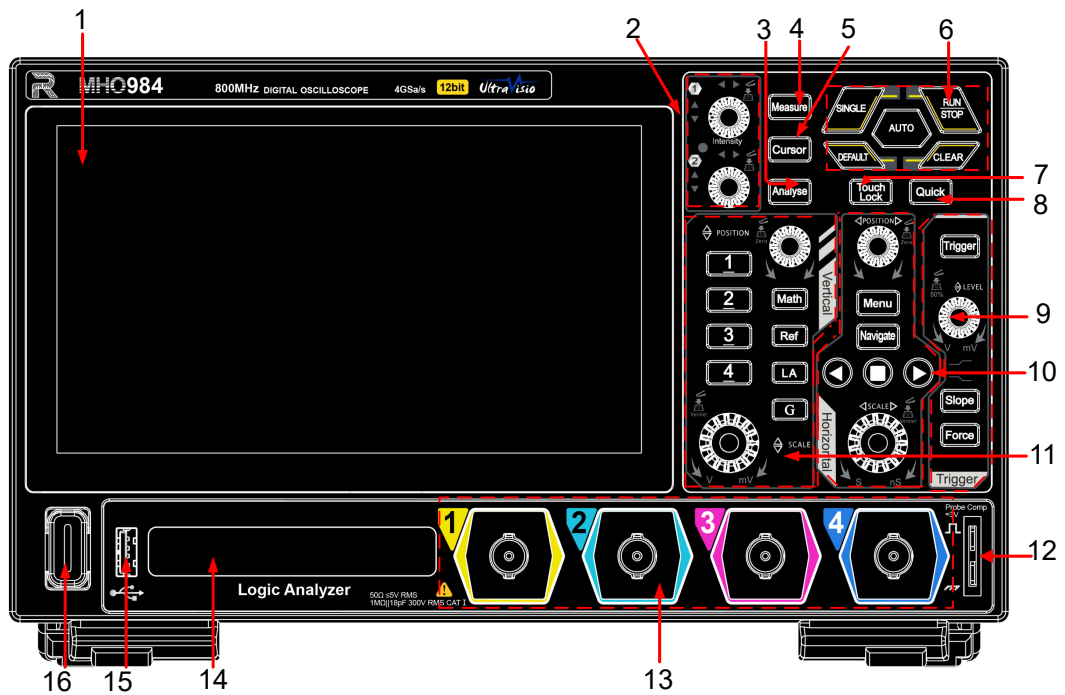
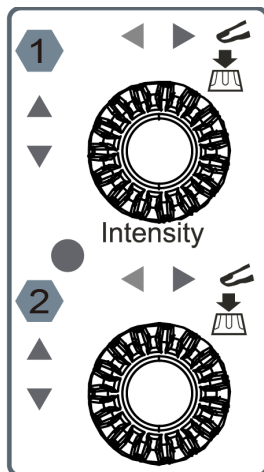

Figure 4.10 Front Panel

#### 1. 7" Capacitive Touch Screen

Displays the waveform, menu name, parameter setting, system state, prompt messages, and etc.

#### 2. Multifunction Knob



#### - Non-menu Operation:

In non-menu-operation mode, rotate knob 1 to adjust the brightness of waveform display. When a cursor, decoding, Math waveform, or reference waveform is added on the screen, rotate the multifunction knob (knob 1 and 2) to move the cursor, adjust the decode threshold (knob 1) and decode result

display position (knob 2), adjust the vertical scale (knob 1) and vertical offset (knob 2) of the math/reference waveform. You can click or tap **Flex Knob** on the toolbar at the upper-right of the screen to set the priority.

- Automatic: Cursor > (Math/Ref/Decode) > Intensity (default priority).
- Manual: all non-menu operation items are listed at the lower part of the **Flex Knob** menu. You can select one of them as the current item for the multifunction knob to adjust.

#### - Menu Operation:

When operating on the menu, you can rotate the multifunction knob 1 or 2 to adjust the value in the menu. When you click or tap the input field and then the **1** or **2** icon is displayed in the input field, it indicates that you can use the specified knob to set the value. The LED indicator of the corresponding knob is illuminated. At this point, you can rotate the knob to adjust the value or press down the knob to restore the parameter to the default value.

When using the virtual numeric keypad or selecting from the drop-down list, you can rotate the knob to navigate through the keypad or select the item from the drop-down list, then press down the knob to select an item.

### 3. Analyse Key

: press this key to enter the "Analyse" interface. You can click or tap "DVM", "Counter", "Record", or "Pass/Fail" to enter the specified function menu.

### 4. Measure Key





: press this key to enter the "Measure" interface. You can select the measurement parameters. For details about the measurement menu, refer to descriptions in *Select the Measurement Item* in "Measure" menu.

### 5. Cursor Key

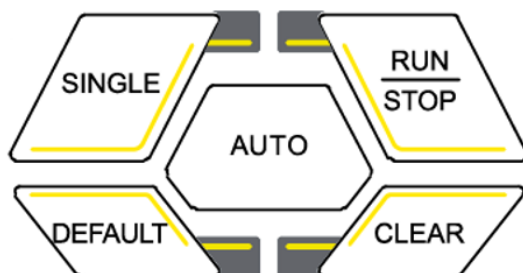
: press this key to enter the cursor measurement interface. The measurement results are displayed in the result list. The oscilloscope provides three cursor modes: Manual, Track, and XY. XY mode is only available when the XY function is enabled.

### 6. Common Operation Key



- : waveform auto setting key. Press this key to enable the waveform auto setting function. The oscilloscope will automatically adjust the vertical scale, horizontal time base, and trigger mode according to the input signal to realize optimal waveform display. For the function of this key, refer to *Auto Config*.
- : runs or stops the instrument. Press this key to set the operating state of the oscilloscope to "RUN" or "STOP". In the "RUN" state, the backlight of the key is illuminated in green. In the "STOP" state, the backlight of the key is illuminated in red.
- : single trigger key. Press this key to set the trigger mode to "Single". The instrument samples one frame of waveforms and then stops.
- : default setting key. Press this key for two consecutive times, or press it once and click or tap **OK** in the prompt message to restore the oscilloscope to its default settings.
- : Clear key. Press this key to clear all the waveforms on the screen. If the oscilloscope is in the "RUN" state, new waveforms will continue being displayed.

## 7. Touch Screen Lock Key

- : pressing this key can disable the touch screen operation. Once disabled, press this key again to enable the touch screen.

## 8. Quick Operation Key

- : press this key to perform the quick operation for the specified function such as saving image, saving waveforms, saving setup files, performing All Measure function, resetting statistics, recording waveforms, saving group, and full screen operation. For the setting of the quick operation key, refer to *Quick Operation*.

## 9. Trigger Control Area

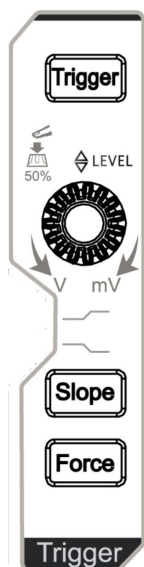

- **Trigger**: trigger setting key. Press this key to open the trigger menu. For the descriptions about trigger operation, refer to *To Trigger the Oscilloscope*.
- **Slope**: trigger edge setting key. Press this key to switch the edge type (rising, falling, or either) of the Edge trigger signal. When Trigger is set to other types other than the edge type, this key is unavailable to use.
- **Force**: force trigger key. Press this key to generate a trigger signal forcibly.
- **LEVEL**: used to modify the trigger level/threshold level. Rotate it clockwise to increase the level, and rotate it counterclockwise to decrease the level. Press down the knob to quickly set the trigger level/threshold level to 50% of the waveform peak-peak value.

## 10. Horizontal Control Area

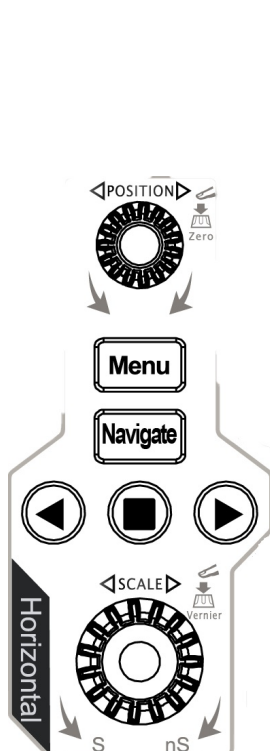





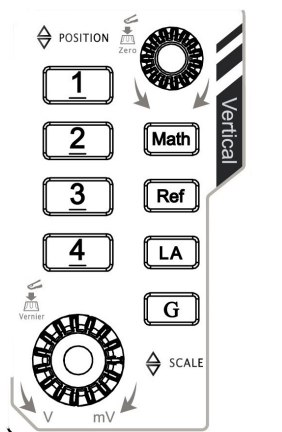

- **Horizontal POSITION** Knob: horizontal position knob. Rotate this knob to modify the horizontal position (that is, trigger position), making the waveforms move left and right. Press down this knob to quickly reset the horizontal position.
- **Horizontal SCALE** Knob: horizontal scale knob. Rotate this knob to modify the horizontal time base of the waveform, then the displayed waveforms of all channels are expanded or compressed horizontally. Press down this knob to switch the horizontal time base adjustment mode between "Coarse" and "Fine"; or enable or disable the zoom function (related to the settings of *Vernier/Zoom*).
- **Menu**: horizontal menu key. Press this key to enter the horizontal system menu. You can set the horizontal system parameters and acquisition system parameters of the instrument.
- **Navigate**: navigation key. Press this key to enter the navigation menu. You can navigate by time or search event. For details about the navigation menu, refer to descriptions in "*Navigation*".

-  : navigation combination key. You can use the key in time navigation, search event navigation, waveform recording and playing.

## 11. Vertical Control Area



-  : math operation key. Press this key to enter the math operation interface. You can perform math operations such as  $A+B$ ,  $A-B$ ,  $A \times B$ ,  $A/B$ , and FFT. Besides, you can also set the math operation label.
-  : reference waveform key. Press this key to enter the reference waveform setting interface. You can compare the actually measured waveform with the reference waveform to locate the circuit failure.
-  : indicates the logic analyzer key. When the logic analyzer probe is connected to the digital channel, press this key to enable or disable the digital channel. When a digital channel is enabled, pressing this key can open the logic analyzer (LA) setting menu. You can enable or disable any channel or channel group, modify the waveform size of the digital channel, modify the threshold of the digital channel, set the digital channel label, and group the 16 digital channels.
-  : Function/Arbitrary Waveform Generator (AFG) key. This function is available to use when the AFG option has been installed. Press this key to open the AFG setting menu. You can set the AFG waveform parameters, enable or disable the current signal output.
- **Vertical**  **POSITION**: channel vertical position knob. Rotate this knob to modify the vertical position of the waveform for the specified channel. The waveforms will move up and down on the screen. Press down the knob to reset the vertical position to zero.
- **Vertical**  **SCALE**: channel vertical scale knob. Rotate this knob to modify the amplitude of each vertical grid of the selected waveform, making its amplitude

increase or decrease. Press down this knob to switch between the coarse and fine adjustment of the vertical scale.

- 1, 2, 3, 4: analog channel key. Press the specified key to enable or disable the specified channel.
  - If this channel is not displayed, pressing the channel key can enable the specified channel in the waveform view.
  - If this channel is displayed on the screen but not selected, pressing the channel key can select the specified channel.
  - If this channel is displayed on the screen and the channel is selected, pressing the specified channel key can disable the channel (the channel is deleted from the waveform view).

## 12. Probe Compensation Signal Output Terminal/Ground Terminal

This terminal outputs the probe compensation signal which helps you match a probe's input capacitance to the oscilloscope channel to which it is connected.

## 13. Analog Channel Input Terminals

BNC connector, used to connect the probe and input the analog signal.

## 14. Digital Channel Input Terminals

Used to connect the logic analyzer probe to input the digital signal.

## 15. USB HOST Interface

Supports FAT32 format USB storage device and USB mouse.

- **USB storage device:** imports or exports data (e.g. instrument software update, waveform file, setup file, and screen image file).
- **USB mouse:** use the externally USB-connected mouse to operate the oscilloscope.

## 16. Power Key

Powers on or off the instrument.

## 4.4.2 Rear Panel

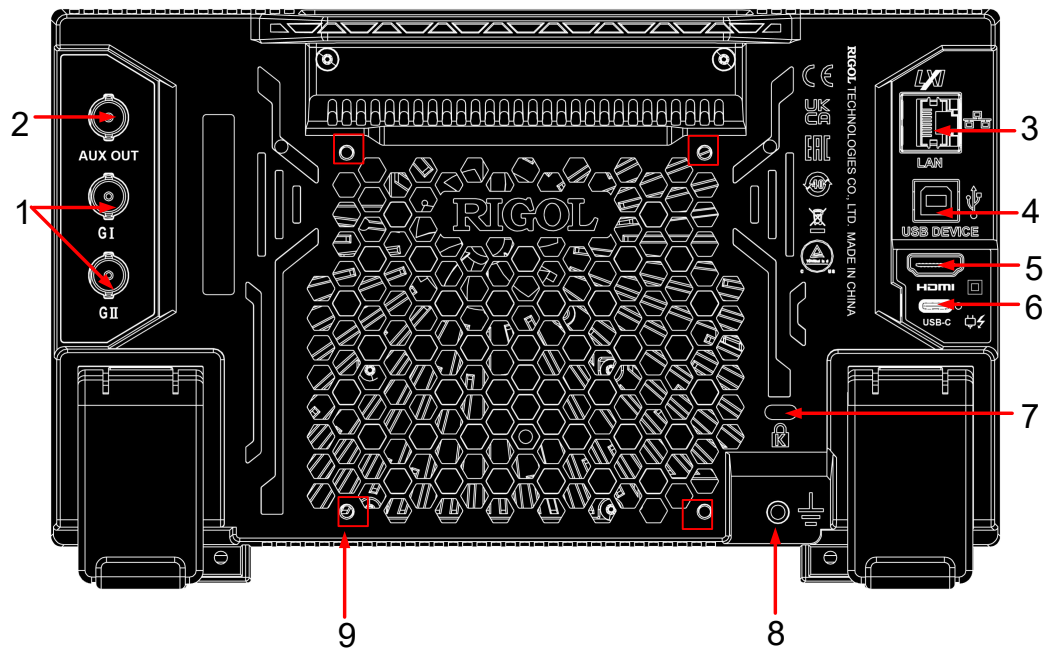

Figure 4.11 Rear Panel

### 1. Function/Arbitrary Waveform Generator Output Interface GI/GII

The AFG function can be enabled only when you have installed the AFG option. When you enable GI or GII, the rear-panel **[GI]** or **[GII]** connector outputs the signal according to the current configuration.

### 2. AUX OUT Output Interface

#### - Trig Out

When "AUX Out" is set to "TrigOut", the oscilloscope initiates a trigger and outputs a signal that can reflect the current capture rate of the oscilloscope at each trigger via this connector. Connect the signal to a waveform display device and measure the frequency of the signal. The measurement result is the same as the current capture rate.

#### - PassFail

When "AUX Out" is set to "PassFail", in the pass/fail test, the instrument will output a pulse via the rear-panel **[AUX OUT]** connector when a passed or failed waveform is detected during the pass/fail test.

### 3. LAN Interface

Connects the instrument to network via this interface. The instrument is in compliance with the standards specified in LXI Device Specification 2011. It can be used to set up a test system with other standard devices. Then you can control the instrument through using Web Control to send the SCPI commands. When update

is available, you can perform online upgrading for the system software of the instrument via the LAN interface.

#### **4. USB DEVICE Interface**

Connects the instrument to the PC via this interface. Then you can use the PC software to send the SCPI commands or use the user-defined programming to control the instrument.

#### **5. HDMI Video Output Interface**

Connects the instrument to an external display that has the HDMI interface (e.g. monitor or projector) via this interface to better observe the waveform display clearly. At this time, you can also view the waveforms on the LCD of the instrument.

#### **6. USB Type-C Power Interface**

The power specification of the instrument is DC, 20 V, 5 A. Please use the power adapter provided in the accessories to connect the instrument to the AC power source (100 V to 240 V, 50 Hz to 60 Hz).

#### **7. Security Lock Hole**

Use a standard PC/laptop lock cable to secure the oscilloscope to a work bench or other location.

#### **8. Ground Terminal**

Use the lead to ground the chassis properly.

#### **9. Bracket Mounting Hole (VESA 100x100)**

VESA 100 mm x 100 mm pattern, with VESA hole spacing of 100 mm x 100 mm. Use the screw to mount the oscilloscope to the bracket with the VESA 100 mm x 100 mm pattern.

## 4.4.3 User Interface

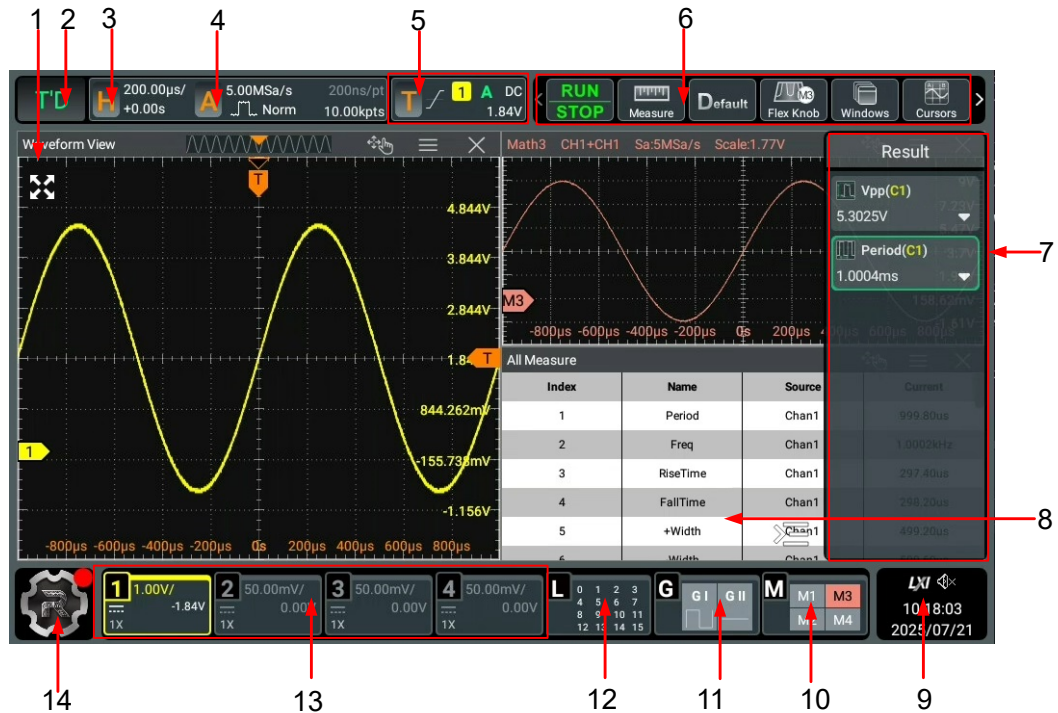





Figure 4.12 User Interface

### 1. Waveform View

Indicates the waveform displays area. Click or tap  at the upper-right corner of the waveform display window to close the window. Click or tap  to enter the configuration menu of the specified function. Click or tap the  icon at the upper-left corner of the waveform view to switch to the full screen for users to better observe the waveforms. At this time, the menu information at the top of the waveform view will be hidden. Click or tap  to restore to the non-full screen window.

### 2. Operating Status

Displays the operating status of the instrument. Available states include RUN, STOP, T'D (triggered), WAIT, and AUTO.

### 3. Horizontal Timebase and Horizontal Position Label

Displays the current horizontal timebase and horizontal position. Click or tap this label to enter the horizontal setting menu.

### 4. Sample Rate & Memory Depth Label

Displays the current sample rate and memory depth. Click or tap this label to enter the horizontal setting menu.

### 5. Trigger Information Label

- Displays the trigger information of the system, including the trigger type, trigger level, trigger mode, and etc.
- Click or tap the trigger information label, then the trigger setting window is displayed. You can set the parameters for the trigger.

### 6. Quick Operation Toolbar

Provides quick operation key for the specified function, such as **STOP/RUN**, **Default**, **Measure**, **Flex Knob**, **Windows**, **Cursors**, **Math**, **XY**, **Storage**, **Counter**, **DVM**, **Decode**, **Record**, and **Navigate**.

### 7. Result List





Displays the measurement results and statistics of various functions. Click or tap  at the lower-right corner of the screen to fold the result list of the specified function.

### 8. Multi-pane Windowing Display Area

If you enable multiple functions, multiple windows can be displayed on the screen at one time.

### 9. Notification Area

Displays the USB storage device icon, LAN connection icon, sound icon, and remote control icon as well as system date and time. You can click or tap this area to open the "Utility" menu.

- USB storage device icon: When a USB storage device is detected,  will be displayed.
- LAN connection icon: When the LAN interface is successfully connected,  is displayed.
- Sound icon: In the "Utility" menu, click or tap **Setup** > **Beeper** to enable or disable the sound. When enabled,  will be displayed; when disabled,  will be displayed. You can also click on or tap the icon to enable or disable the sound.
- Remote control icon: When you use Web Control to control the instrument remotely,  will be displayed.
- Date and Time: If you set "Display Time" to "ON", the system date and time will be displayed.

## 10. Channel Operation Label

- Displays the On/Off status of the math operation (Math1-Math4).
- Click or tap the specified math operation label (**M1-M4**), the specified math operation setting interface is displayed. You can view and set the on/off status of the operation channel (Math1-Math4), its operation type, vertical scale, etc.

## 11. Function/Arbitrary Waveform Generator (Option) Label

Available to use when the AFG option has been installed. Displays the On/Off status of AFG, waveform type, etc. You can enable or disable the AFG output. When the AFG output is enabled, click or tap this label to enter the AFG setting menu.

## 12. Digital Channel Label

Displays the on/off status of the each digital channel. Clicking or tapping the label can enable or disable all the digital channels. When a digital channel is enabled, click or tap this label to enter the logic analyzer (LA) setting menu.

## 13. Channel Status Label

- Displays the on/off status of the specified channel.
- Displays the channel coupling mode.
- Displays the vertical scale of the channel.
- Displays the vertical offset of the channel.
- Displays the probe ratio of the channel.
- Click or tap the label to enable or disable the specified channel and enter the vertical system menu.

## 14. Function Navigation Icon

Click or tap the icon to open the function navigation menu. Click or tap the specified menu icon to enter the specified function setting menu.

If there is a red dot on the upper-right corner of the icon, it indicates that there is an available software version to be updated. To ensure the stability and safety of the upgrade process, we recommend you to perform local upgrade with the official firmware package. Remote upgrading is not recommended.

# 4.5 Touch Screen Gestures

The instrument provides a super large capacitive touch screen, which is convenient for users to operate and make configurations. It has strong waveform display capacity and excellent user experience. It features great convenience, high flexibility, and great sensitivity. The actions supported by the touch screen controls include tapping, pinching&stretching, and dragging.

## 4.5.1 Tap

Use one finger to tap the symbol or characters on the screen slightly, as shown in *Figure 4.13*. With the Tap gesture, you can perform the following operations:

- Tap the menu displayed on the screen to operate on the menu.
- Tap the function navigation icon at the lower-left corner of the touch screen to enable the function navigation.
- Tap the displayed numeric keypad to set the parameters.
- Tap the virtual keypad to set the label name and the filename.
- Tap the close button at the upper-right corner of the message box to close the prompt window.
- Tap other windows on the touch screen and operate on the windows.



**Figure 4.13 Tap Gesture**

## 4.5.2 Drag

Use one finger to select the object, and then drag the object to a destination place, as shown in the figure below. With the drag gesture, you can perform the following operation:

- Drag the waveform to change its position or scale.
- Drag the window controls to change the position of the window (e.g. numeric keypad).
- Drag the cursor to move the cursor.
- Drag the trigger cursor to change the trigger level.

- In multi-window display, drag one of the displayed windows to change its position on the display.

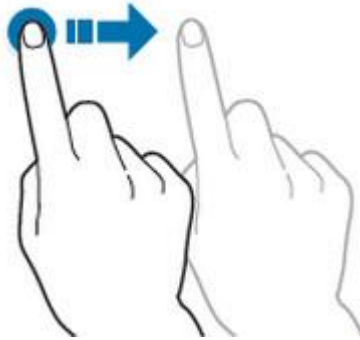

Figure 4.14 Drag Gesture

### 4.5.3 Pinch&Stretch

Pinch or stretch two points on the screen with two fingers to zoom in or out the waveform. To zoom in the waveform, first pinch the two fingers and then stretch the fingers; to zoom out the waveform, first stretch the two fingers, and then pinch the fingers together, as shown in the figure below. With the pinch&stretch gesture, you can perform the following operation:

- Pinching&stretching in the horizontal direction can adjust the horizontal time base of the waveform.
- Pinching&stretching in the vertical direction can adjust the vertical scale of the waveform.



Figure 4.15 Pinch&Stretch Gesture

## 4.6 Parameter Setting Method

For this instrument, you can use the knob and touch screen to set parameters. The common parameter setting methods are as follows:

- **Method 1:** Some parameters can be adjusted by rotating the knob on the front panel.
- **Method 2:** Click or tap the input field of a specified parameter, then a virtual keypad is displayed. Complete the parameter setting with the keypad.

### Input Chinese and English Characters

When naming a label, this instrument supports Chinese/English input method. The following part introduces how to input Chinese and English characters with the Chinese/English input method.

- **Input English Characters**

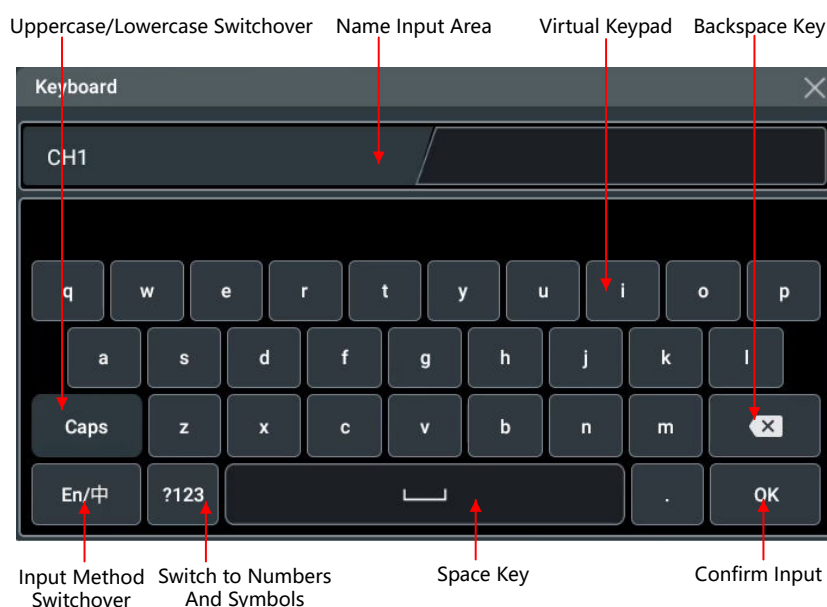

**Figure 4.16 English Input Interface**

#### 1. Select English input method

First check the input method type. If it shows "En/中", then go to Step 2; if it shows "中/En", click or tap the input method switchover key to switch to "En/中" (English input method).

#### 2. Clear the name input area

If there is no character in the "Name Input Area", please go to the next step. If there are characters in the "Name Input Area", click or tap the Backspace key to delete all the characters from the "Name Input Area" in order.

#### 3. Input the upper-case letter

If you want to input an upper-case letter, first use the Caps key to switch between the upper-case and lower-case mode. If the Caps key is selected, input the upper-case letter with the virtual keypad. If not, first click or tap the

Caps key to ensure it is selected, then input the upper-case letter. All the input letters will be displayed in the "Name Input Area".

#### 4. Input the lower-case letter

Refer to the operation specified in the previous step. If the Caps key is not selected, directly input the lower-case letter.

#### 5. Input numbers or symbols

If the letter keypad is displayed, you need to click or tap the numeric switchover key to switch to the numeric keypad, and input numbers or symbols with the numeric keypad. All the input letters will be displayed in the "Name Input Area".

#### 6. Modify or delete the unwanted characters that have been input

During the name input process, you can modify or delete the unwanted character if necessary. To delete the characters that have been input, click or tap the Backspace key in the virtual keypad to delete the characters. To modify the characters that have been input, delete the unwanted characters first and then input the new characters.

You can directly move the cursor to the character to be modified or deleted, delete the desired character or input the new characters after deleting the unwanted character.

#### 7. Confirm the input

After completing the input operation, click or tap "OK".

- **Input Chinese Characters**



**Figure 4.17 Chinese Input Interface**

#### 1. Select Chinese input method

First check the input method type. If it shows "中/En", then go to Step 2; if it shows "En/中", click or tap the input method switchover key to switch to "中/En" (Chinese input method).

## 2. Clear the name input area

If there is no character in the "Name Input Area", please go to the next step. If there are characters in the "Name Input Area", click or tap the Backspace key to delete all the characters from the "Name Input Area" in order.

If there are characters in the "Pinyin Input Area", when you delete characters from the name input area, the characters in the Pinyin input area will be deleted first.

## 3. Input Chinese characters

Click or tap the characters in the virtual keypad to input Pinyin into the input area, then the characters to be selected will be displayed in the Chinese character selection area. Slide to view more Chinese characters for you to choose. Select the desired Chinese character, and then the selected character will be displayed in the input area.

## 4. Modify or delete the unwanted characters that have been input

During the name input process, you can modify or delete the unwanted character if necessary. To delete the characters that have been input, click or tap the Backspace key in the virtual keypad to delete the characters. To modify the characters that have been input, delete the unwanted characters first and then input the new characters.

## 5. Confirm the input

After completing the input operation, click or tap "OK".

### **Input a String**

When naming a file or folder, you need to input a string with the string keypad.

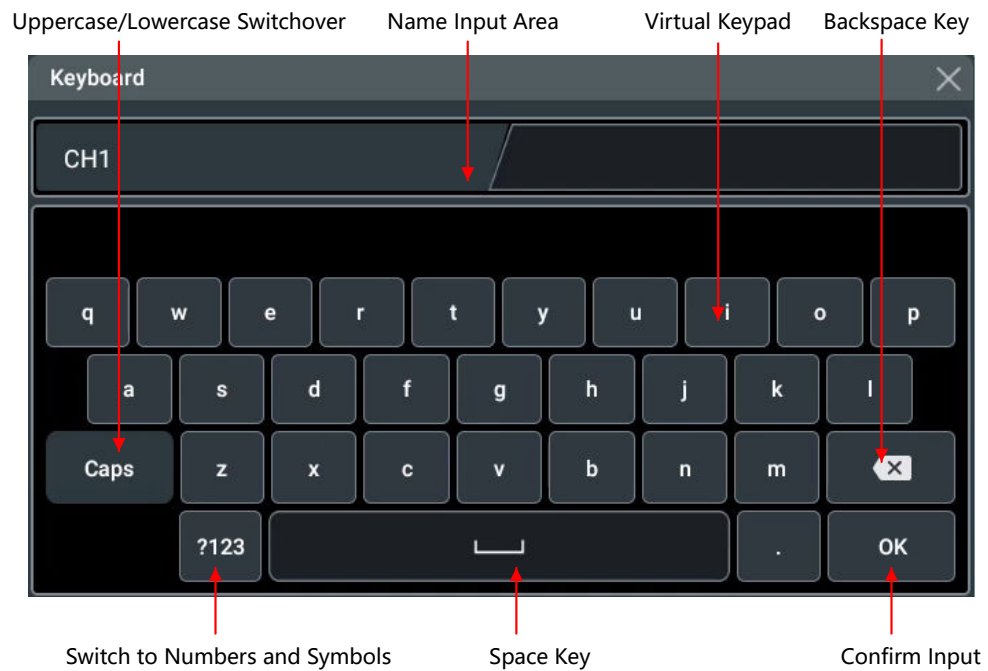

**Figure 4.18 String Keypad**

**1. Clear the name input area**

If there is no character in the "Name Input Area", please go to the next step. If there are characters in the "Name Input Area", click or tap the Backspace key to delete all the characters from the "Name Input Area" in order.

**2. Input the upper-case letter**

If you want to input an upper-case letter, first use the Caps key to switch between the upper-case and lower-case mode. If the Caps key is selected, input the upper-case letter with the virtual keypad. If not, first click or tap the Caps key to ensure it is selected, then input the upper-case letter. All the input letters will be displayed in the "Name Input Area".

**3. Input the lower-case letter**

Refer to the operation specified in the previous step. If the Caps key is not selected, directly input the lower-case letter.

**4. Input numbers or symbols**

If the letter keypad is displayed, you need to click or tap the numeric switchover key to switch to the numeric keypad, and input numbers or symbols with the numeric keypad. All the input letters will be displayed in the "Name Input Area".

**5. Modify or delete the unwanted characters that have been input**

During the name input process, you can modify or delete the unwanted character if necessary. To delete the characters that have been input, click or tap the Backspace key in the virtual keypad to delete the characters. To modify the

characters that have been input, delete the unwanted characters first and then input the new characters.

You can directly move the cursor to the character to be modified or deleted, delete the desired character or input the new characters after deleting the unwanted character.

#### 6. Confirm the input

After completing the input operation, click or tap "OK".

#### Input a Value

When setting or modifying a parameter, input an appropriate value with the numeric keypad.

- Click or tap the value or unit in the numeric keypad to complete the input.
- Rotate the multipurpose knob (1/2) to move the cursor to select the desired value and unit. Press the knob to confirm the input.

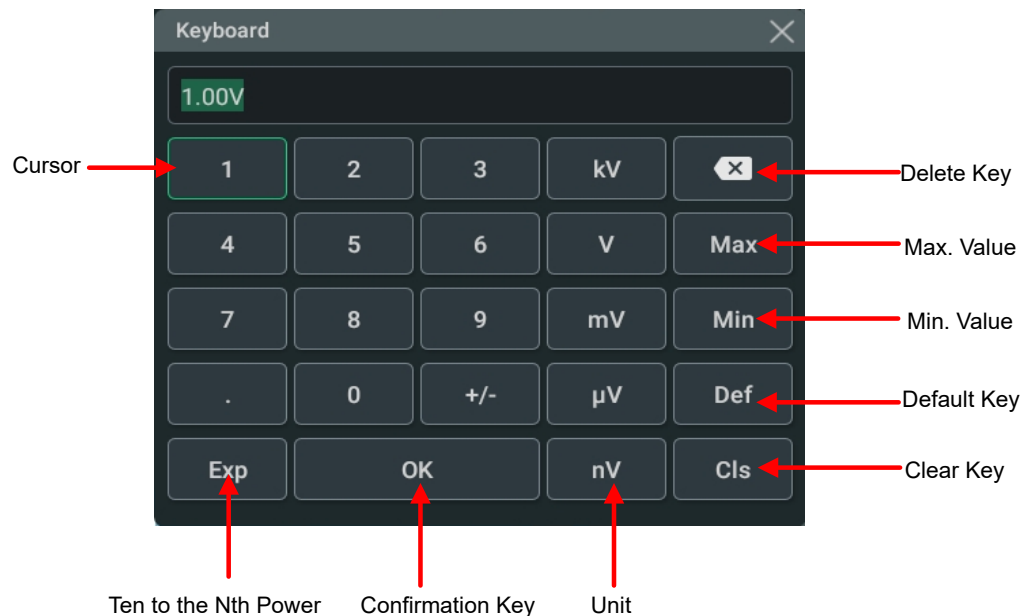

**Figure 4.19 Numeric Keypad**

After you input all the values and select the desired units, the numeric keypad is turned off automatically. This indicates that you have completed parameter setting. Besides, after you have input the values, you can also click or tap "OK" directly to close the numeric keypad. At this time, the unit of the parameter is the default unit. In the numeric keypad, you can perform the following operations:

- Modify the parameter value that has been input;
- Set the parameter value to a maximum or minimum value;
- Set the parameter to a default value;

- Clear the parameter input field.

## 4.7 To Use the Security Lock

If necessary, you can lock the instrument to a fixed location by using the security lock (please purchase it by yourself), as shown in the figure below.

The method is as follows: align the lock with the lock hole and plug it into the lock hole vertically, turn the key clockwise to lock the oscilloscope, and then pull the key out.

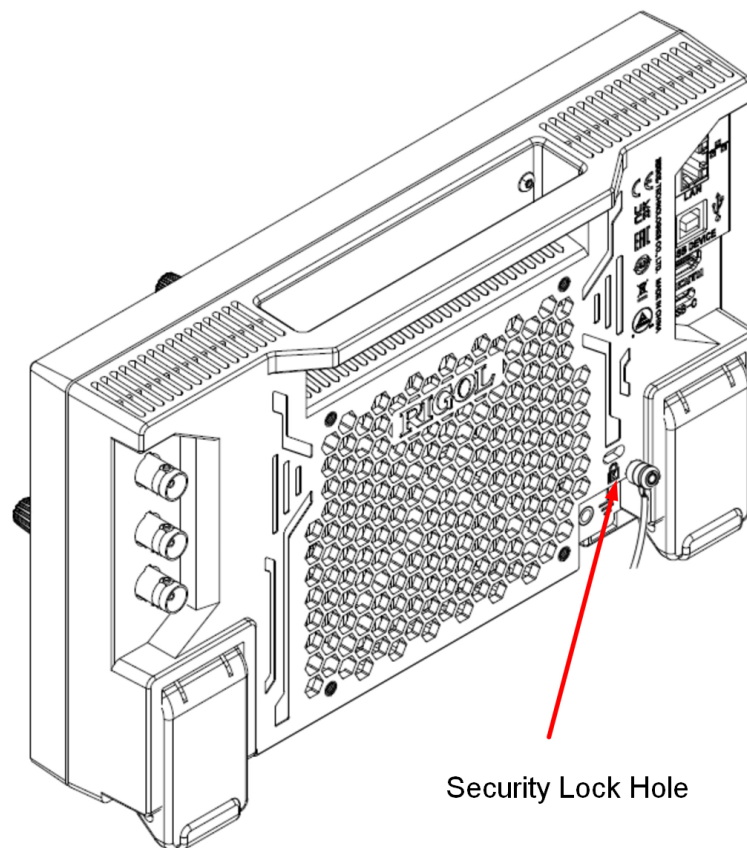

Figure 4.20 Use the Security Lock



### CAUTION

Please do not insert other objects into the security lock hole to avoid damaging the instrument.

## 4.8 To Use the Built-in Help System

The built-in help file provides information about the functions and menu

introductions of the instrument. Click or tap  > **Help** to enter the help system.

In the help system, you can get its help information by clicking on or tapping the link for the specified chapter.

## 5 Vertical System

This oscilloscope provides four analog input channels CH1-CH4. The vertical control system of each channel is independent of each other. The setting method for the vertical system of each channel is the same. This chapter takes CH1 as an example to introduce the setting method for the vertical system.

When a channel is selected, click or tap the channel status label at the bottom of the screen. Then the menu as shown in the figure below is displayed.

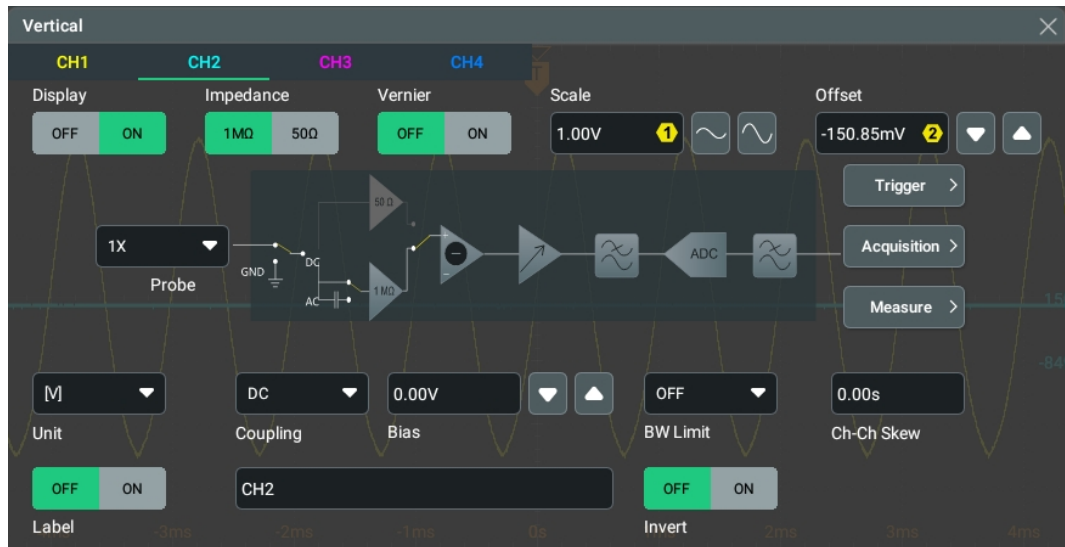



Figure 5.1 Vertical Menu

### 5.1 To Enable or Disable the Analog Channel

#### Enable the Analog Channel

When a signal is connected to CH1, you can enable the channel in the following ways.

- Click or tap the channel status label at the bottom of the screen to enable the channel.
- Press the front-panel  key to enable the channel, and the backlight of this key is illuminated.
- In [Figure 5.1](#), select the CH1 tab. Click or tap the **Display** on/off switch to turn CH1 on or off.

When CH1 is activated, its status label at the bottom of the screen is as shown in the figure below.



The information displayed in the channel status label is related to the current channel setting (irrelevant with the on/off status of the channel). After the channel is turned on, modify the parameters such as the vertical scale, horizontal time base, trigger mode, and trigger level according to the input signal for easy observation and measurement of the waveform.



When CH1 is enabled but not activated, its status label is as shown in the following figure.



Click or tap the channel status label at the bottom of the screen or press the front-panel  key to activate CH1. You can also select the **CH1** tab in Vertical menu to activate it.

### Disable the Analog Channel

You can disable the analog channel in the following ways.

- If CH1 has been enabled and activated, you can press the front-panel  key to disable it directly. You can also click or tap the channel status label at the bottom of the screen to open the Vertical menu and then click or tap the label again to disable the channel.
- If CH1 has been enabled but not activated, first activate the channel. Then press the front-panel  key or use the channel status label to disable CH1.
- In *Figure 5.1*, set **Display** to OFF to disable CH1.
- In addition, you can click or drag to slide down the channel label to disable the channel.

If CH1 is disabled, its status label is as shown in the figure below.

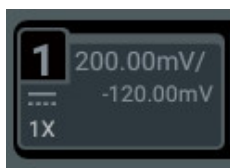

## 5.2 To Adjust the Vertical Scale

Vertical scale indicates the voltage value per grid in the vertical axis of the screen. It is often expressed in V/div. Adjusting the vertical scale increases or decreases the display amplitude of the waveform. The scale information of the channel status label at the bottom of the screen would change accordingly.

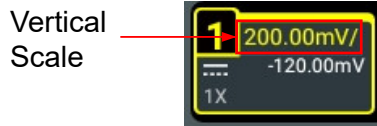

The adjustable range of the vertical scale is related to the current probe ratio and input impedance. By default, the probe ratio is 1X. In this case, when the input impedance is set to 1 M $\Omega$ , the adjustable range of the vertical scale is from 1 mV/div to 10 V/div. When the input impedance is set to 50  $\Omega$ , the adjustable range of the vertical scale is from 200  $\mu$ V/div to 1 V/div.

When CH1 is turned on and activated, you can adjust the vertical scale in the following ways.

- Rotate the **Vertical SCALE** knob to adjust the vertical scale. Clockwise to reduce the scale and counterclockwise to increase.
- Enable the touch screen function, and then adjust the vertical scale with the pinch & stretch gesture on the touch screen. For details, refer to descriptions in *Pinch&Stretch*.
- In the **Vertical** menu, click or tap the icon at the right side of the input field of **Scale** to increase or decrease the scale value or use the corresponding multifunction knob on the front panel to set the value. You can also click or tap the input field to input a specific value with the displayed numeric keypad.

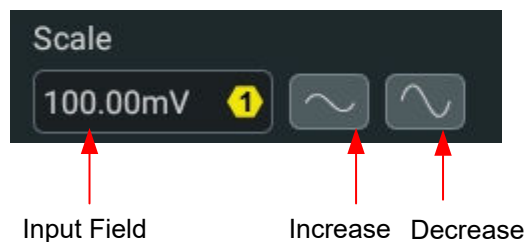

In the **Vertical** menu, click or tap the ON/OFF tab for **Vernier** to toggle between ON (fine adjustment) and OFF (coarse adjustment). The default setting is OFF. You can

also press down the **Vertical SCALE** knob to toggle between "coarse adjustment" and "fine adjustment".

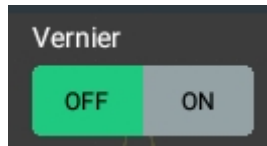

- **Fine adjustment:** Use the icons at the right side of **Scale** or rotate the knob to further adjust the vertical scale within a relatively smaller range to improve vertical resolution. If the amplitude of the input waveform is a little bit greater than the full scale under the current scale and the amplitude would be a little bit lower if the next scale is used, fine adjustment can be used to improve the amplitude of waveform display to view signal details.
- **Coarse adjustment:** Use the icons at the right side of **Scale** or rotate the knob to adjust the vertical scale in 1-2-5 step, i.e. 200  $\mu\text{V}/\text{div}$ , 500  $\mu\text{V}/\text{div}$ , 1  $\text{mV}/\text{div}$ , 2  $\text{mV}/\text{div}$ , 5  $\text{mV}/\text{div}$ , 10  $\text{mV}/\text{div}$ ...1  $\text{V}/\text{div}$ .

## 5.3 To Adjust the Vertical Offset

Vertical offset indicates the offset of the signal ground level position of the waveform from the screen center in the vertical direction. Its unit is consistent with the currently selected amplitude unit (refer to *To Specify the Amplitude Unit*). When adjusting the vertical offset, the waveforms of the corresponding channel move up and down. The vertical offset information (as shown in the following figure) in the channel status label at the bottom of the screen will change accordingly.



The adjustable range of the vertical offset is related to the current probe ratio, vertical scale and input impedance.

When CH1 is turned on and activated, you can adjust the vertical offset in the following ways.

- Rotate the **Vertical POSITION** knob at the right section of the front panel to adjust the vertical offset within the adjustable range. Rotate this knob clockwise to increase the vertical offset or counterclockwise to reduce the vertical offset. Pressing down the knob can quickly reset the vertical offset (set the vertical offset to 0).
- Enable the touch screen function, and then adjust the vertical offset with the drag gesture. For parameters details, refer to *Drag*.
- In the **Vertical** menu, use the corresponding multifunction knob to set the vertical offset or use the icons at the right side of the input field of **Offset** to increase or decrease the value, as shown in the figure below. You can also click or tap the input field to input a specific value with the pop-up numeric keypad.



## 5.4 To Specify the Channel Coupling

You can remove unwanted signals by setting the coupling mode. For example, the signal under test is a square waveform with DC offset.

Click or tap the channel status label at the bottom of the screen, and then the **Vertical** menu is displayed. Click or tap the **Coupling** drop-down button to select the coupling mode.

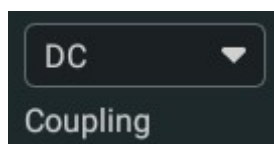

- When the coupling mode is "DC", both the DC and AC components of the signal under test can pass the channel.
- When the coupling mode is "AC", the DC components of the signal under test are blocked.
- When the coupling mode is "GND", the GND waveform is displayed.

After a coupling mode is selected, it is indicated in the channel status label at the bottom of the screen, as shown in the figure below.

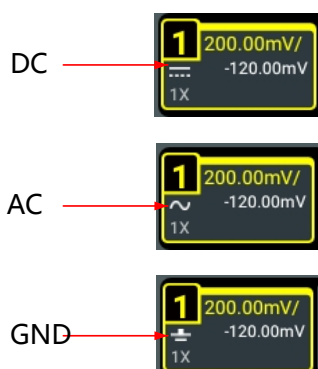

### TIP

When the input impedance is set to "50  $\Omega$ ", the channel coupling is fixed to DC coupling and cannot be modified.



## 5.5 To Specify the Bandwidth Limit

This oscilloscope supports the bandwidth limit function. Setting the bandwidth limit can reduce the noises in the displayed waveforms. For example, the signal under test is a pulse with high frequency oscillation.

- When the bandwidth limit is turned off, the high frequency components of the signal under test can pass the channel.
- When the bandwidth limit is turned on, the high frequency components found in the signal under test that are greater than the limit are attenuated. The supported bandwidth limits include 250 MHz and 20 MHz.

Click or tap the channel status label at the bottom of the screen, and then the **Vertical** menu is displayed. Click or tap the **BW Limit** drop-down button to select the specified bandwidth. When the bandwidth limit is enabled, the specific bandwidth limit value will be displayed in the channel status label at the bottom of the screen, as shown in the figure below.



### TIP

- Bandwidth limit can not only reduce the noise, but also can attenuate or eliminate the high frequency components of the signal.
- When the vertical scale is less than or equal to 500  $\mu\text{V}$ , you cannot turn off the bandwidth limit.
- When the vertical scale is less than or equal to 200  $\mu\text{V}$ , the bandwidth limit is fixed to 20 MHz.

## 5.6 To Specify the Input Impedance

To reduce the circuit load between the oscilloscope and the circuit under test, this oscilloscope provides two input impedance modes: 1 M $\Omega$  and 50  $\Omega$ . In the **Vertical** menu, click or tap to select "1 M $\Omega$ " or "50  $\Omega$ " for **Impedance**.

- 1 M $\Omega$ : In this mode, the input impedance of the oscilloscope is very high, and the current flowed from the circuit under test can be ignored.
- 50  $\Omega$ : makes the oscilloscope match the device whose output impedance is 50  $\Omega$ .

After the oscilloscope switches to the 1 M $\Omega$  mode, the circuit diagram in the **Vertical** menu will also be changed, as shown in the figure below.

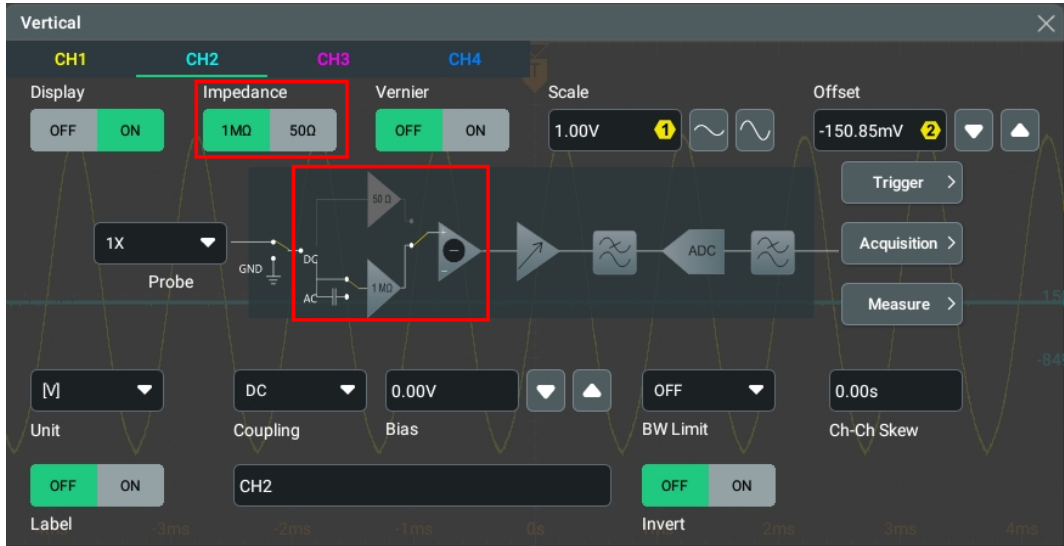

Figure 5.2 Switched Input Impedance



**TIP**

Setting the input impedance affects the ranges of vertical scale and offset for the specified channel.

## 5.7 To Invert a Waveform

Click or tap the channel status label at the bottom of the screen, and then the **Vertical** menu is displayed. Then click or tap the **Invert** on/off switch to enable or disable the waveform invert function.

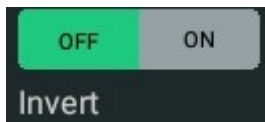

When "ON" is selected, the channel label is as shown in the figure below.



When the Invert function is disabled, the waveform is displayed normally; when enabled, the voltage values of the displayed waveform are inverted, as shown in the figure below. Inverting a waveform also changes the result of math function, waveform measurement, etc.

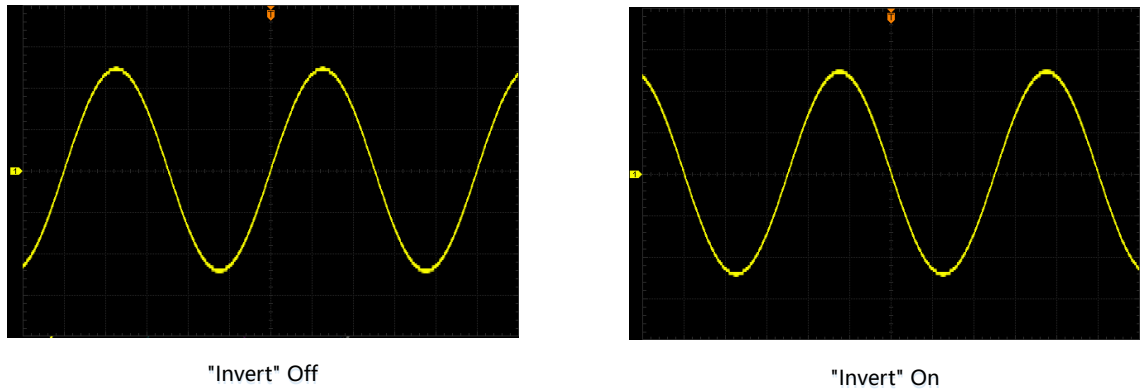

Figure 5.3 Waveform Invert On/Off



#### TIP

When the Invert function is turned on, the trigger (e.g. Edge trigger, Pulse trigger, or Slope trigger) edge or polarity will be changed.

## 5.8 To Set the Probe

The analog channel of this oscilloscope supports passive probes. For detailed technical information of the probes, please refer to the corresponding Probe User Guide.

Enable the touch screen operation and click or tap the channel status label at the bottom of the screen. Then the **Vertical** system interface is displayed. Then click or tap the drop-down list of the probe ratio to set the probe ratio.

### Probe Ratio

The probe ratio is defined as the percentage of the voltage of the signal under test to the probe voltage output to the oscilloscope. The higher the probe ratio, the higher the probe sensitivity, indicating that more low-level signals can be detected.

You are allowed to set the probe ratio manually. To obtain the accurate measurement results, you must set the probe ratio properly according to the actual attenuation value of the selected probe. By default, the probe ratio is 1X.

When a voltage probe is connected to the oscilloscope, refer to *To Specify the Amplitude Unit* to set the amplitude unit to V. The following table lists the preset probe ratio of the oscilloscope. You can also set a user-defined probe ratio according to your needs.

Table 5.1 Probe Ratio

Menu	Attenuation (display amplitude of the signal: actual amplitude of the signal)
0.001X	0.001:1
0.002X	0.002:1
0.005X	0.005:1
0.01X	0.01:1
0.02X	0.02:1
0.05X	0.05:1
0.1X	0.1:1
0.2X	0.2:1
0.5X	0.5:1
1X (default)	1:1
2X	2:1
5X	5:1
10X	10:1
15X	15:1
20X	20:1
50X	50:1
100X	100:1
150X	150:1
200X	200:1
500X	500:1
1000X	1000:1
1500X	1500:1
2000X	2000:1
5000X	5000:1
10000X	10000:1
15000X	15000:1
20000X	20000:1

Menu	Attenuation (display amplitude of the signal: actual amplitude of the signal)
50000X	50000:1

## 5.9 To Specify the Amplitude Unit

Click or tap the channel status label at the bottom of the screen, and then the **Vertical** menu is displayed. Click or tap the **Unit** drop-down button to select W, A, V, or U. The default unit is V.

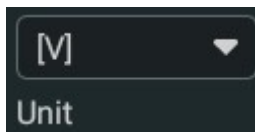

Changing the amplitude unit also changes the units of the functions related to the channel accordingly.

## 5.10 Bias

When you use an oscilloscope to make actual measurements, a small offset that arises from the temperature drift of the component or external environment disturbance may occur on the zero-cross voltage of the channel, which will affect the measurement results of the vertical parameters. This oscilloscope allows you to set an offset calibration voltage for calibrating the zero point of the corresponding channel so as to improve the accuracy of the measurement results.

In the "Vertical" menu, click or tap the Up/Down arrow icon at the right side of the input field of **Bias** to increase or decrease the bias value. You can click or tap the input field to set the value with the pop-up numeric keypad. You can also use the corresponding multifunction knob to set the value.



The range of bias is related to the vertical scale and input impedance.

### TIP

If the zero-cross voltage of the channel has a larger amplitude offset that exceeds the adjustable range, please perform self-calibration for the instrument to ensure the measurement accuracy. For details, refer to *SelfCal*.



## 5.11 To Specify the Skew

Channel skew refers to the time difference (zero offset) between two or more input channels caused by factors such as variations in signal transmission paths, probe cables, oscilloscope internal circuits, etc. For example, when signals from Channel 1 and Channel 2 are displayed, one waveform might appear slightly earlier or later than the other, resulting in channel skew. This series oscilloscope allows you to set a delay time for calibrating the zero offset of the corresponding channel. Zero offset is defined as the offset of the crossing point of the waveform and trigger level line relative to trigger position, as shown in the figure below.

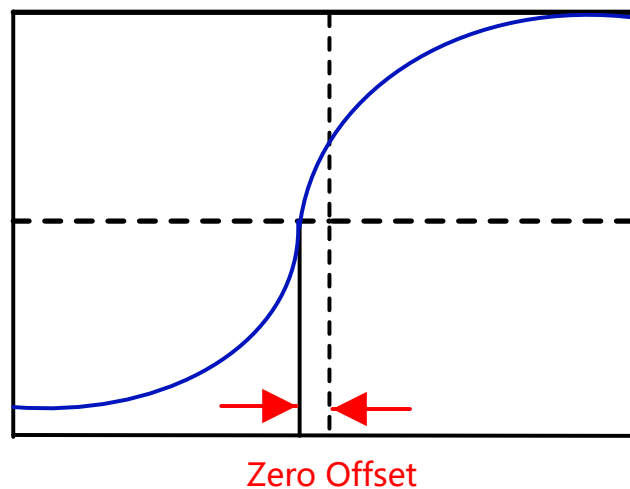
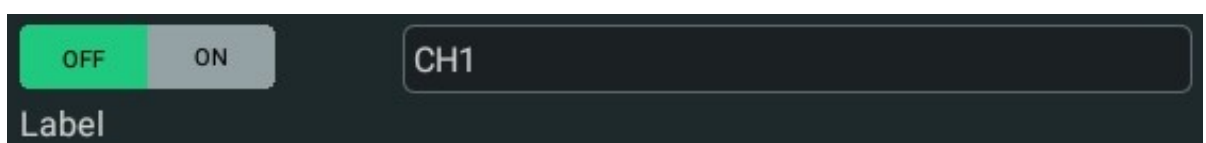

Figure 5.4 Zero Offset

In the "Vertical" menu, click or tap the **Ch-Ch Skew** input field to set the channel-to-channel skew time. The available range is from -100 ns to 100 ns, and the default is 0.00 s.

## 5.12 To Turn the Channel Label Display On/Off

The instrument uses the channel number to mark the corresponding channel by default. For ease of use, you can also set a label for each channel. For example, **CH1**. Click or tap the channel status label at the bottom of the screen. Then the **Vertical** menu is displayed. Click or tap the **Label** on/off switch to turn the label display on or off. You can also click or tap the label input field to input a specific name for the channel label with the pop-up keypad.



For how to use the keypad, refer to descriptions in *Parameter Setting Method*.

## 6 Horizontal System

To enter the **Horizontal** system menu, perform any of the following operations.

- Click or tap the channel status label at the bottom of the screen, and then the **Vertical** menu is displayed. Click or tap the **Acquisition** button to enter the **Horizontal** menu.
- Click or tap the horizontal time base/horizontal position label ("H" icon) or sample rate/memory depth label ("A" icon) at the top of the screen to enter the **Horizontal** menu.

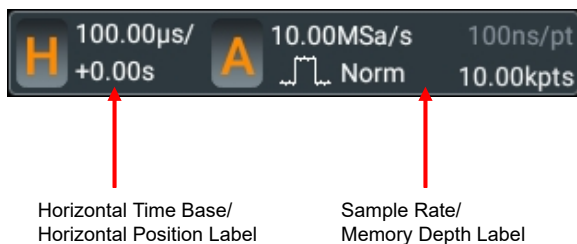

- Press the front-panel **Menu** key to enter the **Horizontal** menu.

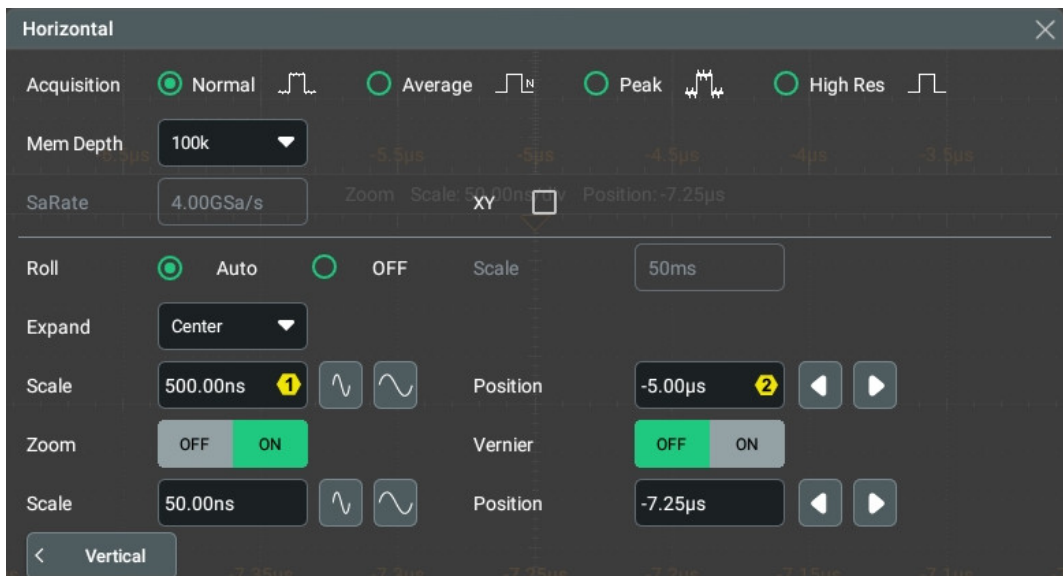

Figure 6.1 Horizontal Menu

### 6.1 To Adjust the Horizontal Time Base

Horizontal time base, also called the horizontal scale, refers to the time of each grid in the horizontal direction of the screen. It is usually expressed in s/div. The range of the horizontal time base is from 500.00 ps/div to 500 s/div.

While you change the horizontal time base, the displayed waveforms of all channels are expanded or compressed horizontally relative to the selected time reference

(*Horizontal Expansion Reference*). The horizontal time base in the horizontal time base label ("H" icon) will change accordingly, as shown in the figure below.



You can adjust the horizontal time base in the following ways.

- Rotate the **Horizontal SCALE** knob at the right section of the front panel to adjust the horizontal time base within the adjustable range. Clockwise to decrease the scale and counterclockwise to increase the scale.
- Enable the touch screen function, and then adjust the horizontal time base with the Pinch&Stretch gesture. For details, refer to *Pinch&Stretch*.
- In the **Horizontal** menu, click or tap the icon at the right side of the input field of **Scale** to increase or decrease the horizontal time base or use the corresponding multifunction knob to set the value. You can also click or tap the input field to input a specific value with the pop-up numeric keypad.

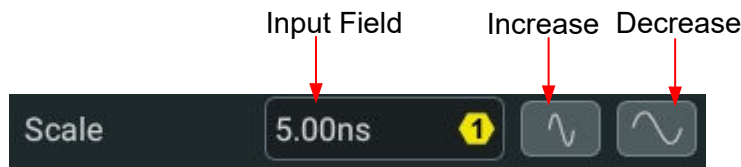

In the **Horizontal** menu, click or tap the **Vernier** on/off switch to toggle between ON (fine adjustment) and OFF (coarse adjustment). You can also press the front-panel

**Horizontal SCALE** knob to toggle between "coarse adjustment" and "fine adjustment".

- **Coarse adjustment:** Click or tap the icons at the right side of the input field of **Scale** to adjust the horizontal time base of the waveforms of all channels in a 1-2-5 step sequence within the adjustable range.
- **Fine adjustment:** Click or tap the icon at the right side of the input field of **Scale** to adjust the horizontal time base of the waveforms of all channels at a smaller step within the adjustable range.

## 6.2 To Adjust the Horizontal Position

Horizontal position, also called trigger position, refers to the trigger point position of the waveforms of all channels in the horizontal direction relative to the center of the display. When the waveform trigger point is at the left (right) side of the center, the horizontal position is a positive (negative) value.

Changing the horizontal position moves the waveform trigger points and the displayed waveforms of all channels horizontally. The horizontal position displayed in the horizontal position label changes accordingly, as shown in the figure below.



You can adjust the horizontal position in the following ways.

- Rotate the **Horizontal POSITION** knob at the right section of the front panel to adjust the horizontal position within the adjustable range. Rotate this knob clockwise to reduce the horizontal position or counterclockwise to increase the horizontal position. Pressing the knob can quickly reset the horizontal position (set the horizontal position to 0).
- Enable the touch screen function, and then adjust the horizontal position with the drag gesture. For details, refer to *Drag*.
- In the "Horizontal" menu, use the corresponding multifunction knob to set the horizontal position or use the icons at the right side of the input field of **Position** to increase or decrease the value, as shown in the figure below. You can also click or tap the **Position** input field to input a specific value with the pop-up numeric keypad.

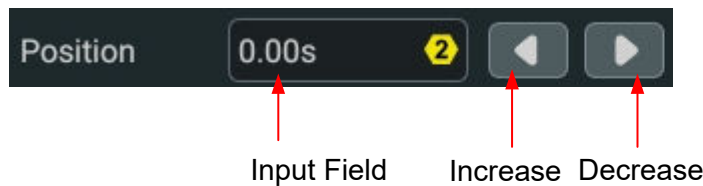

## 6.3 Zoom Mode (Delayed Sweep)

Zoom mode (delayed sweep) can be used to horizontally expand a length of waveform to view waveform details. In the **Horizontal** menu, click or tap the **Zoom** on/off switch to enable or disable the delayed sweep function. When it is enabled, you can set the scale and position in Zoom mode.

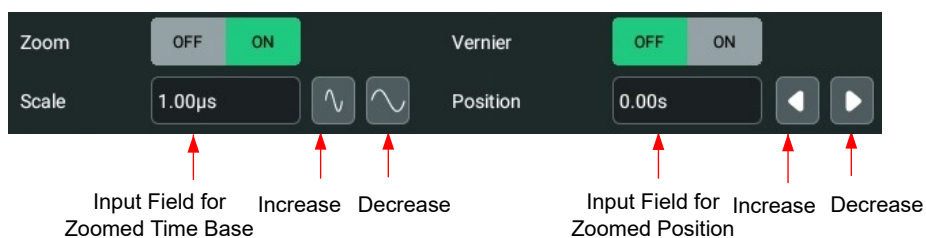

- **Zoomed Scale:** Rotate the corresponding multifunction knob or use the icons at the right side of the **Scale** input field to increase or decrease the time base for

the Zoom window. You can also click or tap the input field to input the specific value directly via the pop-up numeric keypad.

- **Zoomed Position:** Rotate the corresponding multifunction knob or use the icons at the right side of the **Position** input field to increase or decrease the position for the Zoom window. You can also click or tap the input field to input the specific value directly via the pop-up numeric keypad.

When the Zoom mode is enabled, the display divides in half, as shown in the figure below.

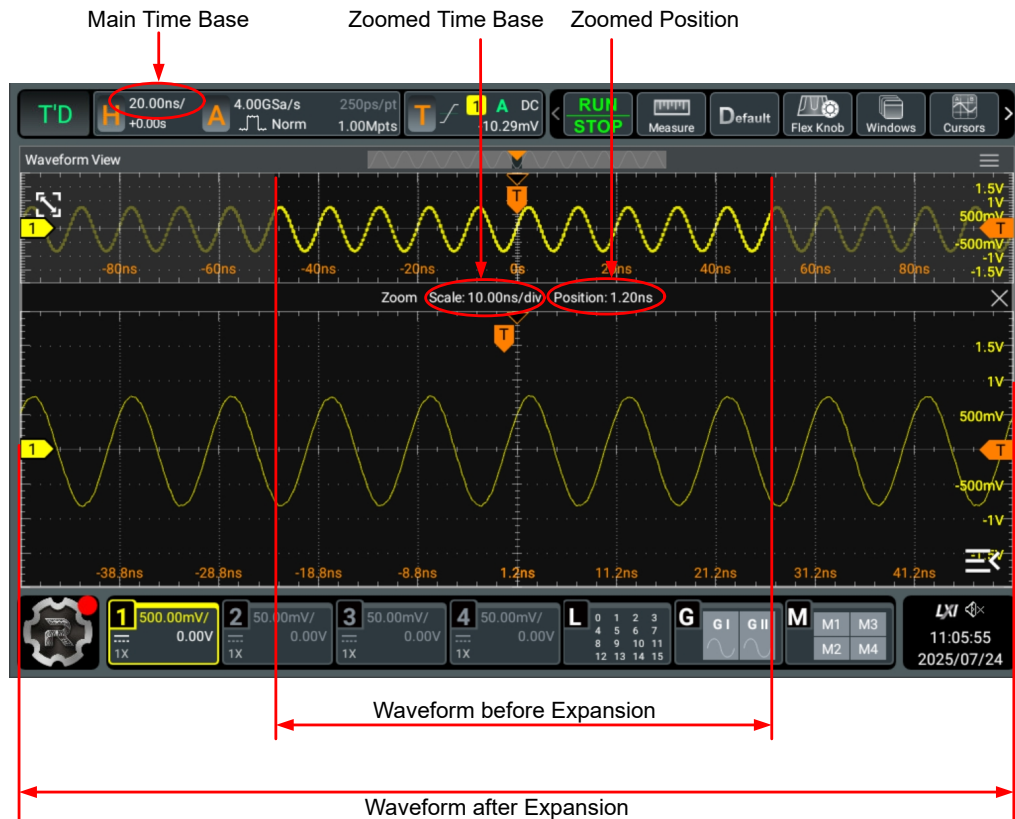

**Figure 6.2 Zoom Mode**

- **Waveform before expansion:**  
The upper portion of the display that is not covered by subtransparent gray shows the normal display of the waveform. Its horizontal time base (called the main time base) is indicated in the label at the upper-left corner of the display. You can move the area left and right by adjusting the horizontal position and increase or decrease the size of the area by adjusting the horizontal scale.
- **Waveform after expansion:**  
The lower portion shows the horizontally expanded version of the normal waveform display. Its horizontal time base (called the zoomed time base) is displayed in the middle. Compared with the main time base, the zoomed time base has higher resolution.



**TIP**

The zoomed time base should be smaller than or equal to the main time base.

## 7 Acquisition System

The "Horizontal" menu allows you to configure the instrument's acquisition system.

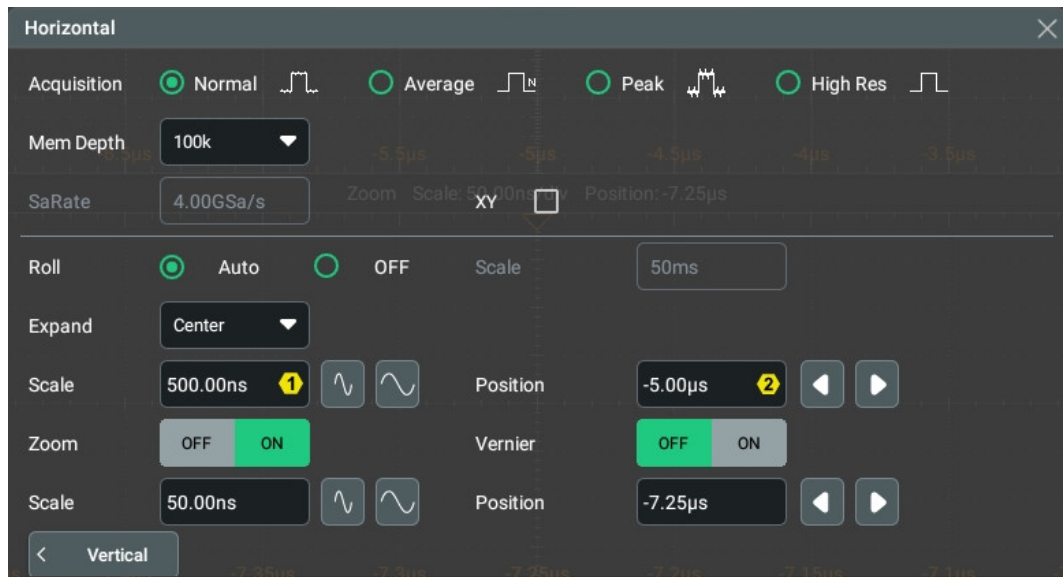

Figure 7.1 Horizontal Menu

### 7.1 Acquisition Mode

The acquisition mode is used to control how to generate waveform points from the sample points. In the **Horizontal** menu, click or tap the desired acquisition mode for the **Acquisition** item. The available choices include Normal, Average, Peak, and High Res. By default, the acquisition mode is Normal. The acquisition mode will be displayed in the acquisition label at the top of the screen.



#### Normal

In Normal acquisition mode, the oscilloscope samples the signal at a fixed time interval to rebuild the waveform. For most of the waveforms, this mode is adopted to achieve optimal display effects.

#### Average

In this mode, the oscilloscope averages the waveforms from multiple acquisitions to reduce the random noise of the input signal and increase the vertical resolution. A greater number of averages lowers the noise and increases the vertical resolution. On the other hand, the higher the number of averages, the slower the response of the displayed waveform to waveform changes.

When you select "Average" mode, click or tap the **Averages** input field to set the number of averages with the pop-up numeric keypad or use the corresponding multifunction knob to set the value. Its range is from 2 to 65536, and the default is 2.

**TIP**

The number of averages must be the Nth power of 2. When it is not in N power-of-2 increments, a prompt message "Truncation average error" is displayed. At this time, a value that is smaller than the one you input and the closest to N power-of-2 increments will be input automatically.

**Peak**

In this mode, the oscilloscope acquires the maximum and minimum values of the signal within the acquisition interval to get the signal envelope or capture narrow pulses that might be lost. This mode prevents signal aliasing at the expense of exaggerating the noise.

In this mode, the minimum pulse width detected is the sample period.

**High Resolution**

This mode uses a kind of ultra-sample technique to average the neighboring points of the sample waveform to reduce the random noise on the input signal and generate much smoother waveforms on the screen. This is generally used when the sample rate of the digital converter is higher than the storage rate of the acquisition memory.

When you select "High Res" mode, click or tap the drop-down button of **Bits** to select 14 (default) or 16. The bandwidth that corresponds to the selected bit is displayed at the right side of the input field of Bits.



**TIP**

- The averaging modes of the "Average" and "High Res" are different. The former uses "Multi-sample Average" and the latter uses "Single Sample Average".
- In "High Res" mode, the oscilloscope improves the measurement accuracy at the cost of bandwidth. Each time the sample rate changes, the current bandwidth is indicated at the right side of **Bits** in the horizontal system menu.

## 7.2 Sampling Mode

This oscilloscope only supports the real-time sampling mode. In this mode, the oscilloscope produces the waveform display from samples collected during one trigger event. The maximum real-time sample rate of this series is 4 GSa/s. The current sample rate is displayed in the acquisition label at the top of the screen.

By default, the operating status label at the left top of the screen is illuminated in green, indicating that the instrument is in real-time sampling, and the **STOP/RUN** button on the toolbar is in green. Click or tap the **STOP/RUN** button or press the

front-panel  key to stop sampling. At this time, the operating status label shows "STOP" in red, and the **STOP/RUN** button turns red. Also, the backlight of the front-panel  key turns red. The oscilloscope will maintain its last captured graph. You can still pan or zoom the waveforms by using the horizontal/vertical controls.

## 7.3 Sample Rate

Sampling is the process of converting an analog signal into digital data at a specified time interval and then storing them sequentially in acquisition memory. The sample rate is the reciprocal of the time interval.

In **Horizontal** menu, the "SaRate" item shows the current sample rate. The current sample rate is also indicated in the acquisition label ("A" icon) at the top of the screen, as shown in the figure below.

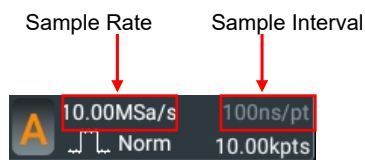

The sample rate of the analog channel is related to the current channel mode. The oscilloscope provides up to 4 GSa/s real-time sample rate in single channel mode, 2 GSa/s real-time sample rate in half channels mode, and 1 GSa/s real-time sample rate in all channels mode.

- **Single channel mode:** If any one of the channels is enabled, it is called single channel mode.
- **Half channels mode:** If two of the channels are enabled, it is called half channels mode.
- **All channels mode:** If any three channels or all four channels are enabled, it is called all channels mode.

A sample rate that is too low might have the following effects on the waveform:

- **Waveform Distortion:** When the sample rate is too low, some waveform details are lost, and the sample waveform displayed is rather different from the actual waveform of the signal.

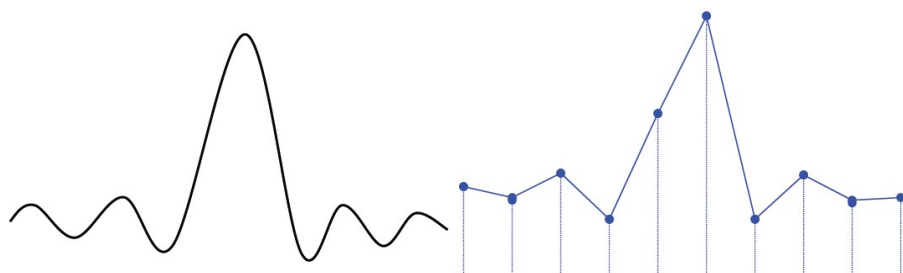

- **Waveform Aliasing:** Aliasing occurs when the sample rate is twice lower than the actual signal frequency (Nyquist Frequency). The frequency of the waveform reconstructed from the sample data is smaller than the actual signal frequency.

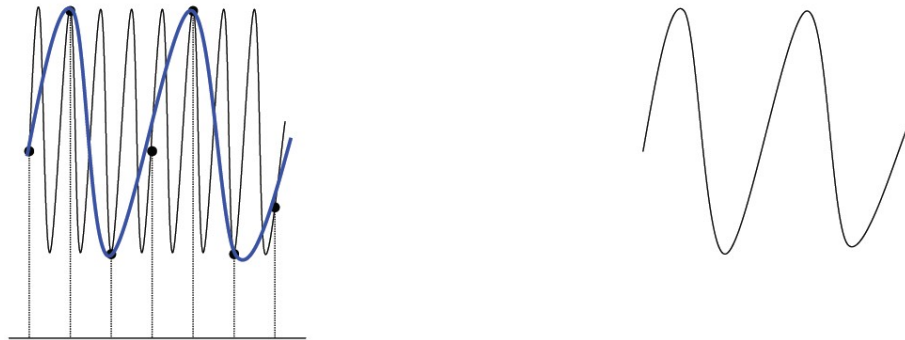

- **Waveform Leakage:** If the sample rate is too low, the waveform reconstructed from the sample data does not represent the original signal correctly.

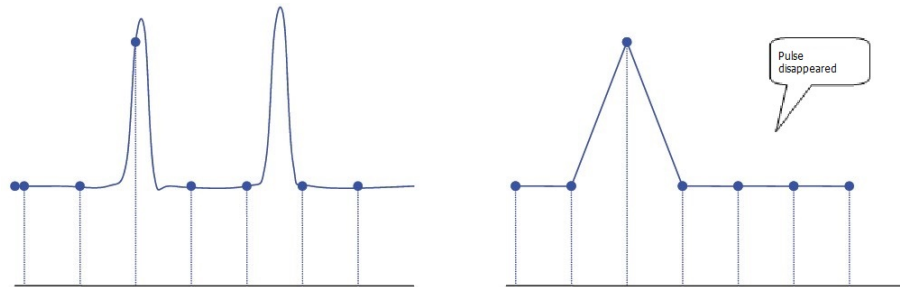

## 7.4 Memory Depth

Memory depth refers to the number of points that the oscilloscope can store in a single trigger acquisition. It reflects the storage capability of the acquisition memory. This series oscilloscope has a standard memory depth of 100 Mpts and provides the optional memory depth of 500 Mpts.

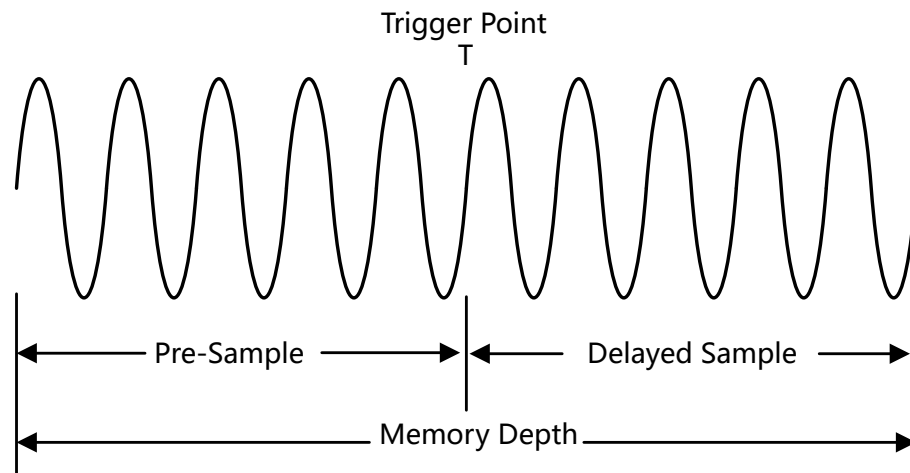

**Figure 7.2 Memory Depth**

The following formula shows the relations among memory depth, sample rate, and horizontal time base:

$$MDepth \geq SRate \times TScale \times HDivs$$

- ***MDepth*** indicates the memory depth. The unit is pts.
- ***SRate*** indicates the sample rate. The unit is Sa/s. The sample rate is limited to a discrete set of values.
- ***TScale*** indicates the horizontal time base. The unit is s/div.
- ***HDivs*** indicates the number of grids in the horizontal direction. The unit is div. The basic horizontal time base can be adjusted in 1-2-5 step.

Therefore, with the same horizontal time base, a higher memory depth can ensure a higher sample rate.

In **Horizontal** menu, click or tap the **Mem Depth** drop-down button to select the memory depth. The default setting is "10k". The selected memory depth value is displayed in the acquisition label ("A" icon) at the top of the screen.

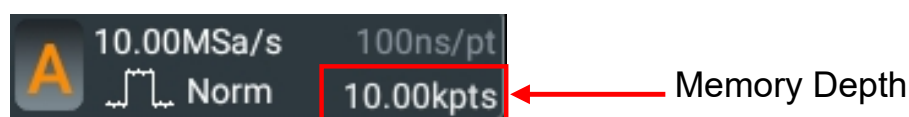

- When only one of the four channels (CH1-CH4) is enabled, the memory depths available include Auto, 1 kpts, 10 kpts, 100 kpts, 1 Mpts, 10 Mpts, 25 Mpts, 50 Mpts, 100 Mpts, 125 Mpts (option), 200 Mpts (option), 250 Mpts (option), and 500 Mpts (option).
- When two of the four channels (CH1-CH4) is enabled, the memory depths available include Auto, 1 kpts, 10 kpts, 100 kpts, 1 Mpts, 10 Mpts, 25 Mpts, 50 Mpts, 100 Mpts (option), 125 Mpts (option), 200 Mpts (option), and 250 Mpts (option).

- When three channels or all four channels are enabled, the memory depths available include Auto, 1 kpts, 10 kpts, 100 kpts, 1 Mpts, 10 Mpts, 25 Mpts, 50 Mpts (option), 100 Mpts (option), 125 Mpts (option).

**TIP**

- In "Auto" mode, the oscilloscope selects the memory depth automatically according to the current sample rate.
- When *Acquisition Mode* is set to "High Res", "Auto" is not available for the memory depth setting.
- When *Acquisition Mode* is set to "Average", the maximum memory depth available is 50 Mpts in single channel mode, 25 Mpts in half channels mode, and 10 Mpts in all channels mode.

## 7.5 Horizontal Expansion Reference

This function allows you to set the position that the waveform on the display is referenced to when it is horizontally expanded or compressed when the horizontal time base is adjusted. In the **Horizontal** menu, click or tap the **Expand** drop-down button to select the reference position. Available options include Center (default), Left, Right, Trigger, and User.

- **Center:** when the horizontal time base is modified, the waveform will be expanded or compressed horizontally relative to the center of the display.
- **Left:** when the horizontal time base is modified, the waveform will be expanded or compressed horizontally relative to the leftmost position of the display.
- **Right:** when the horizontal time base is modified, the waveform will be expanded or compressed horizontally relative to the rightmost position of the display.
- **Trigger:** when the horizontal time base is modified, the waveform will be expanded or compressed horizontally relative to the trigger point.
- **User:** when the horizontal time base is modified, the waveform will be expanded or compressed horizontally relative to the user-defined reference position.

When you select "User", click or tap the **User Expansion** input field and set the value with the displayed numeric keypad. Its range is from -500 to 500, and the default is 0.

## 7.6 Roll Mode

The roll mode causes the waveform to move across the screen from right to left. It allows you to view the acquired data without waiting for a complete acquisition. In **Horizontal** menu, select "Auto" or "OFF" in **Roll**.

- Auto: the Roll mode is enabled. It is automatically enabled when the horizontal scale is 50 ms/div or slower.
- OFF: disables the Roll mode. When the horizontal time base is equal to or greater than 200 ms/div, the instrument enters slow sweep mode. In slow sweep mode, the oscilloscope acquires the data to the left of the trigger point and then waits for trigger. After the trigger occurs, it continues to acquire the data to the right of the trigger point. The oscilloscope displays the pre-trigger waveform once, and the post-trigger waveform refreshes in a sweep mode from left to right. When you use this mode to observe low-frequency signals, it is recommended to set the channel coupling mode (*To Specify the Channel Coupling*) to "DC".



#### TIP

- If the Zoom mode is currently turned on, enabling the roll mode automatically turns off the Zoom mode.
- The following functions are not available when the roll mode is enabled and the oscilloscope's run state is "RUN":

*To Adjust the Horizontal Position Zoom Mode (Delayed Sweep), To Trigger the Oscilloscope, Waveform Recording and Playing, Persistence Time, Average, XY Mode, Histogram Analysis, Protocol Decoding, Pass/Fail Test, Search.*

## 7.7 XY Mode

By default, this series oscilloscope uses the YT mode for waveform display window. In YT mode, Y-axis indicates the Voltage and X-axis indicates the Time. Besides, it supports XY display window. In this display window, X-axis and Y-axis indicate voltage. The two input channels display from "Voltage-Time" to "Voltage-Voltage".

### Enable the XY Mode

You can enable the XY display mode in the following ways.

- Click or tap the **Windows** button in the function navigation menu or on the toolbar to enter the **Add Window** menu. In the "Diagram" item, click or tap **XY** > **Add** to enable the XY display mode.
- Click or tap the **XY** button in the function navigation menu or on the toolbar to enable the XY display mode.
- In the "Horizontal" menu, tick **XY** to enable the XY mode.

### Configure the XY Mode

Click or tap  at the upper-right corner of the XY display window to enter the XY configuration menu.

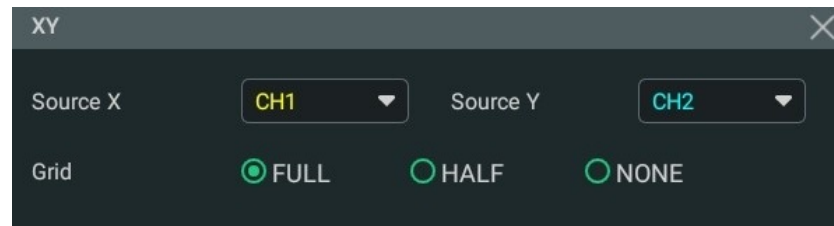
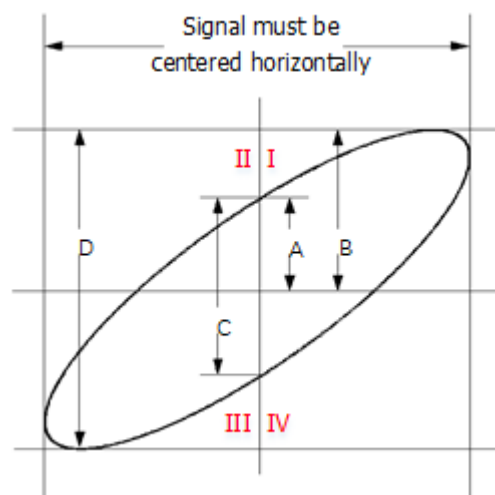

**Figure 7.3 XY Menu**

- **Source:** Click or tap the drop-down button of Source X to select the source channel of the X-axis in the XY window. Click or tap the drop-down button of Source Y to select the source channel of the Y-axis in the XY window.
- **Grid:** Please refer to *To Set the Screen Grid* to set the grid of the XY window.

### Phase Deviation Measurement

In this mode, you can use the Lissajous method to measure the phase deviation of the two input signals whose frequencies are the same. The following figure shows the measurement schematic diagram of phase deviation.



**Figure 7.4 Measurement Schematic Diagram of Phase Deviation**

According to  $\sin\theta = A/B$  or  $C/D$ ,  $\theta$  is the phase deviation angle between the two channels. The definitions of A, B, C, and D are shown in the figure above. The phase deviation angle is obtained, that is:

$$\theta = \pm \arcsin(A/B) \text{ or } \pm \arcsin(C/D)$$

If the principal axis of the ellipse is within Quadrant I and III, the phase deviation angle obtained should be within Quadrant I and IV, namely within  $(0 \text{ to } \pi/2)$  or  $(3\pi/2 \text{ to } 2\pi)$ . If the principal axis of the ellipse is within Quadrant II and IV, the phase deviation angle obtained should be within Quadrant II and III, namely within  $(\pi/2 \text{ to } \pi)$  or  $(\pi \text{ to } 3\pi/2)$ .

The XY mode can be used to measure the phase deviation occurred when the signal under test passes through a circuit network. Connect the oscilloscope to the circuit to monitor the input and output signals of the circuit.

## 8 To Trigger the Oscilloscope

The trigger system allows you to set specific trigger conditions as required. The oscilloscope captures a waveform as well as its neighboring part and displays them on the screen once a particular trigger condition is met. For a digital oscilloscope, it samples waveform ceaselessly no matter whether it is stably triggered. However, only stable triggering can guarantee the stable display of waveforms. The trigger module ensures that every time base sweep or acquisition starts from the user-defined trigger condition, namely every sweep is synchronous with the acquisition and the waveforms acquired are overlapped so as to display the stable waveforms.

You should set the triggers based on the features of the input signal. To quickly capture your desired waveforms, you need to understand the signal under test. This oscilloscope provides a variety of trigger types that help you focus on the desired waveform details.

You can enter the **Trigger** menu in the following ways.

- Press the front-panel  key to enter the trigger menu.
- In the Vertical menu, click or tap the **Trigger** button to enter the trigger setting menu.
- Click or tap the trigger label (as shown in the figure below) at the top of the screen to enter the trigger menu.

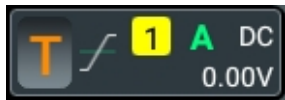

### 8.1 Trigger Source

In the "Trigger" menu, click or tap the drop-down button of **Source** to select the desired source. Available sources include analog channels CH1-CH4 and digital channels D0-D15 (available only when the digital channel probe is connected).

#### Analog Channel Input

Signals input from analog channels CH1-CH4 can all be used as trigger sources. No matter whether the channel selected is enabled, the channel can work normally.

#### Digital Channel Input

When the digital channel probe is connected, signals input from digital channels D0-D15 can all be used as trigger sources. No matter whether the channel selected is enabled, the channel can work normally.



## 8.2 Trigger Level

Trigger level determines the position of the trigger point on the edge. The adjustment of the trigger level is related to the type of the trigger source.

- When the trigger source is analog channel or digital channel, rotate the front-panel  **LEVEL** knob or use the corresponding multifunction knob (when the trigger menu is opened) to adjust the trigger level. You can also click or tap the input field of Level to set the value with the pop-up numeric keypad.

When the trigger source is D0-D15, you can set the threshold level for digital channels in the basic settings tab of the "Digital Channel" menu. For details, refer to "To Set the Threshold". The current threshold level is displayed in the trigger information label at the top of the screen.

During the adjustment, a trigger level line (the color of the trigger level line is the same as that of the channel) and a trigger icon "" are displayed on the screen, and they move up and down with the variation of the trigger level. When you stop modifying the trigger level, the trigger level line disappears in about 2s. The current trigger level is displayed in the trigger information label at the top of the screen.

In Runt Trigger, Slope Trigger, and Window trigger, you need to set the upper and lower limits of the trigger level. Two trigger level icons  and  are displayed at the right section of the screen.

To better trigger the waveforms, for a trigger with a single level, you can directly click or tap **50%** in the menu or press down the trigger level knob to make the level move to the middle of the waveform. However, for a trigger with two levels (e.g. Slope trigger, Runt trigger, Window trigger and MIL-STD-1553 trigger), you need to click or tap **90%** for Level A and **10%** for Level B to make the level move within the range of the waveform amplitude.

## 8.3 Trigger Mode

The following is the schematic diagram of the acquisition memory. To better understand the trigger event, you can think of the trigger event as dividing acquisition memory into a pre-trigger and post-trigger buffer.

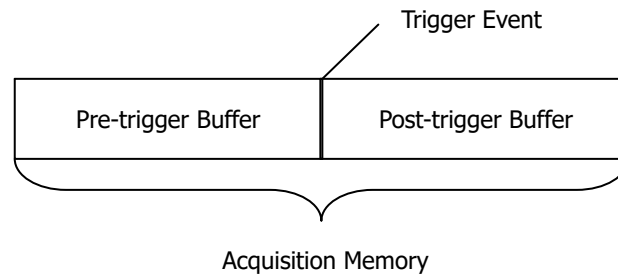

**Figure 8.1 Schematic Diagram of the Acquisition Memory**

After the oscilloscope starts running, it first fills the pre-trigger buffer. Then, after the pre-trigger buffer is filled, the oscilloscope starts searching for a trigger. While searching for the trigger, the data sampled will still be transmitted to the pre-trigger buffer (the new data will continuously overwrite the previous data). When a trigger is found, the pre-trigger buffer contains the events that occurred just before the trigger. Then, the oscilloscope will fill the post-trigger buffer and display the data in the

acquisition memory. If the acquisition is initiated via the front-panel  key, the

process repeats; if the acquisition is initiated via the  key, it stops after finishing a single acquisition (you can pan and zoom the currently displayed waveform).

This series provides Auto (default), Normal, and Single trigger modes.

Click or tap the trigger information label (as shown in the figure below) at the top of

the screen or press the front-panel  key to open the "Trigger" menu. In the **Sweep** item, you can quickly switch the current trigger mode. The selected trigger mode is displayed in the trigger information label at the top of the screen: A (Auto), N (Normal), or S (Single).

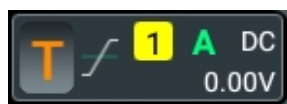

- **Auto:** In this trigger mode, if the specified trigger conditions are not found, the oscilloscope will trigger automatically at regular intervals to display the acquired waveform. This trigger mode can be used when the signal levels are unknown, when the DC signals should be displayed, or when trigger conditions occur often enough that forced triggers are unnecessary.
- **Normal:** In this trigger mode, triggers and acquisitions only occur when the specified trigger conditions are found. This trigger mode can be used when the signal is at a low repetition rate, when you only want to acquire specific events specified by the trigger settings, or when you try to stabilize the display by preventing the oscilloscope from auto-triggering.
- **Single:** In this trigger mode, a single trigger and acquisition only occur when the specified trigger conditions are found, and then the oscilloscope stops. This

trigger mode can be used when you need to make a single acquisition of the specified event and analyze the acquisition result. You can pan and zoom the currently displayed waveform without subsequent waveform data overwriting the current waveform. After a single trigger is initiated, the oscilloscope is in "STOP" state.

In this three trigger modes, you can click or tap the **Force** button in the trigger menu or press the front-panel  key to force a trigger event.

## 8.4 Trigger Coupling

Trigger coupling decides which kind of components will be transmitted to the trigger module. Please distinguish it from channel coupling ([To Specify the Channel Coupling](#)). This function is available only when the trigger type is Edge and the trigger source is an analog channel.

In the "Trigger" menu, click or tap the drop-down button of **Coupling** to select the desired coupling mode (by default, it is DC).

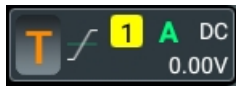

- DC: allows DC and AC components to pass the trigger circuitry.
- AC: blocks the DC components and attenuates the signals.
- LFR: blocks the DC components and rejects the low-frequency components, realized by the high-pass filter.
- HFR: rejects the high-frequency components, realized by the low-pass filter.



### TIP

When "AC" or "LFR" is selected as the coupling mode, no trigger level lines and trigger icons are displayed. When you adjust the trigger level, you can only see the changes of the trigger level values in the trigger information label at the top of the screen.

## 8.5 Trigger Holdoff

Trigger holdoff can help stabilize triggering on complex repetitive waveforms that have multiple edges or other events between waveform repetitions (such as pulse series). Holdoff time is specified as the amount of time that the oscilloscope waits for re-arming the trigger circuitry after generating a correct trigger. The oscilloscope will not trigger even if the trigger condition is met during the holdoff time and will only re-arm the trigger circuitry after the holdoff time expires.

For example, to get a stable trigger on the repetitive pulse burst as shown in the figure below, set the holdoff time to be greater than  $t_1$  but less than  $t_2$ .

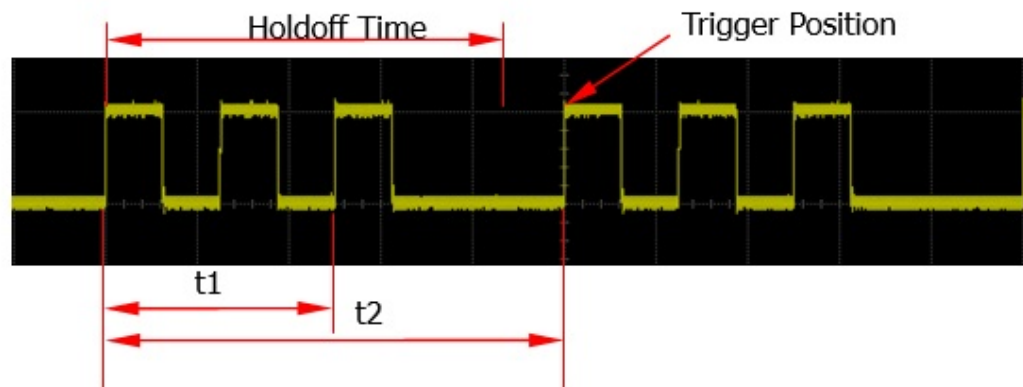

**Figure 8.2 Trigger Holdoff**

Click or tap the trigger information label (as shown in the figure below) at the top of the screen or press the front-panel Trigger key to open the "Trigger" menu. Click or tap the input field of **Holdoff** to set the holdoff time with the pop-up numeric keypad to make it to trigger stably. By default, it is 8 ns. You can also use the corresponding multifunction knob to set the value. The adjustable range of the holdoff time is from 8 ns to 10 s.

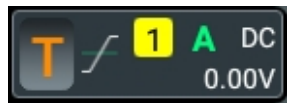

## 8.6 Noise Rejection

Noise rejection can reject the high frequency noise in the signal and reduce the possibility of miss-trigger of the oscilloscope.

Click or tap the trigger information label (as shown in the figure below) or press the front-panel Trigger key to open the "Trigger" menu. Click or tap the **Noise Reject** on/off switch to enable or disable the noise rejection function.

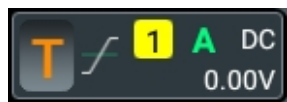

## 8.7 Trigger Type

The oscilloscope provides the following trigger types.

## 8.7.1 Edge Trigger

Edge trigger identifies a trigger on the trigger level of the specified edge on the input signal.

### Trigger Type

Click or tap the **Type** drop-down button to select "Edge".

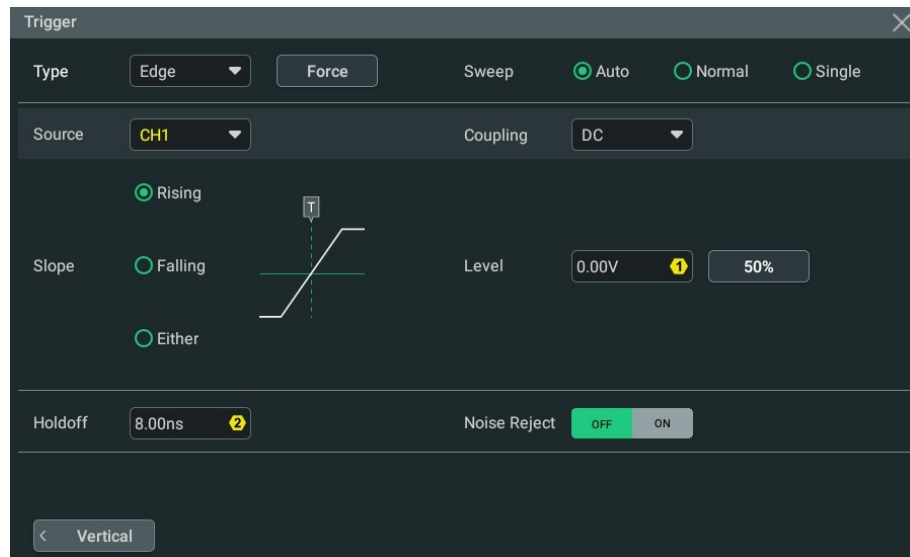
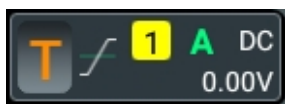

Figure 8.3 Edge Trigger Setting Menu

After a trigger type is selected, the current trigger setting information (including the trigger type, source, and level) is displayed in the trigger information label at the top of the screen, as shown in the figure below. The information will change based on the trigger settings.



### Source Selection

Click or tap the **Source** drop-down button to select CH1-CH4 or D0-D15. For details, refer to *Trigger Source*. The selected trigger source is indicated in the trigger information label at the top of the screen.

Only when you select the channel that has been input with signals as the trigger source, can you obtain a stable trigger.

### Edge Type

In the **Slope** item, select which edge of the input signal will trigger the oscilloscope. The selected slope will be indicated in the trigger information label.

- Rising: triggers on the rising edge of the input signal when the voltage level meets the specified trigger level.
- Falling: triggers on the falling edge of the input signal when the voltage level meets the specified trigger level.
- Either: triggers on the rising or falling edge of the input signal when the voltage level meets the preset trigger level.

**TIP**

When edge trigger is selected, you can also press the front-panel Slope key to switch the edge type.

## 8.7.2 Pulse Width Trigger

Pulse width triggering sets the oscilloscope to trigger on the positive or negative pulse of a specified width. In this mode, the oscilloscope will trigger when the pulse width of the input signal satisfies the specified pulse width condition.

In this oscilloscope, positive pulse width is defined as the time difference between the two crossing points of the trigger level and positive pulse; negative pulse width is defined as the time difference between the two crossing points of the trigger level and negative pulse, as shown in the figure below.

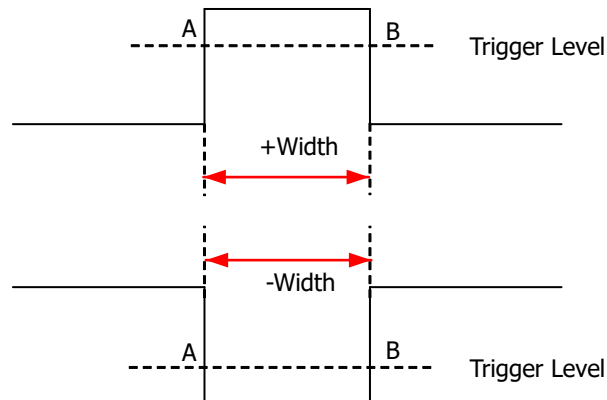

**Figure 8.4 Positive/Negative Pulse Width**

**Trigger Type**

Click or tap the drop-down button of **Type** to select "Pulse".

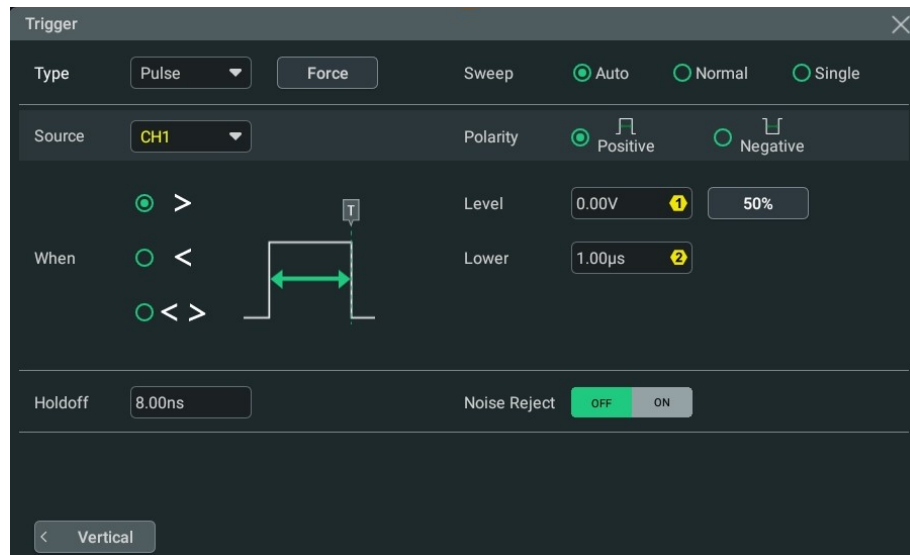

**Figure 8.5 Pulse Width Trigger Setting Menu**

After a trigger type is selected, the current trigger setting information (including the trigger type, source, and level) is displayed in the trigger information label at the top of the screen, as shown in the figure below. The information will change based on the trigger settings.

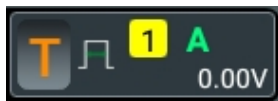



### Source Selection

Click or tap the **Source** drop-down button to select CH1-CH4 or D0-D15. For details, refer to *Trigger Source*. The selected trigger source is indicated in the trigger information label at the top of the screen.

Only when you select the channel that has been input with signals as the trigger source, can you obtain a stable trigger.

### Polarity

In the **Polarity** item, select the desired polarity: positive polarity () or negative polarity ()

### Trigger Condition

Set the trigger condition in the **When** item.

- When you select "Positive" for polarity, ">" for trigger condition, the oscilloscope triggers when the positive pulse width of the input signal is greater than the specified pulse width.

- When you select "Positive" for polarity, "<" for trigger condition, the oscilloscope triggers when the positive pulse width of the input signal is smaller than the specified pulse width.
- When you select "Positive" for polarity, "< >" for trigger condition, the oscilloscope triggers when the positive pulse width of the input signal is greater than the specified lower limit of pulse width and smaller than the specified upper limit of pulse width.
- When you select "Negative" for polarity, ">" for trigger condition, the oscilloscope triggers when the negative pulse width of the input signal is greater than the specified pulse width.
- When you select "Negative" for polarity, "<" for trigger condition, the oscilloscope triggers when the negative pulse width of the input signal is smaller than the specified pulse width.
- When you select "Negative" for polarity, "< >" for trigger condition, the oscilloscope triggers when the negative pulse width of the input signal is greater than the specified lower limit of pulse width and smaller than the specified upper limit of pulse width.

#### Pulse Width Setting

- In the **When** menu, when "<" or ">" is selected, click or tap the input field of **Upper** or **lower** to set the upper limit value or the lower limit value with the pop-up numeric keypad. You can also use the corresponding multifunction knob to set the value. The pulse width available is from 1 ns to 10 s.
- In the **When** menu, when "< >" is selected, click or tap the input field of **Upper** and **Lower** respectively to set the upper limit value and the lower limit value with the pop-up numeric keypad. You can also use the corresponding multifunction knob to set the values. The lower limit of the pulse width must be smaller than the upper limit.

### 8.7.3 Slope Trigger

In Slope trigger, the oscilloscope triggers on the positive or negative slope of the specified time. This trigger type is applicable to ramp and triangle waveforms.

In this oscilloscope, positive slope time is defined as the time difference between the two crossing points of trigger level line A and B with the rising edge; negative slope time is defined as the time difference between the two crossing points of trigger level line A and B with the falling edge. See the figure below.

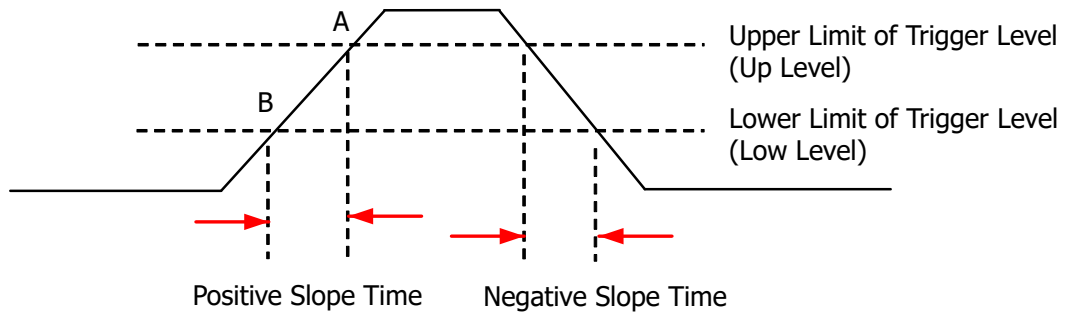

**Figure 8.6 Positive Slope Time/Negative Slope Time**

### Trigger Type

Click or tap the drop-down button of **Type** to select "Slope". Then set the parameters for Slope trigger.

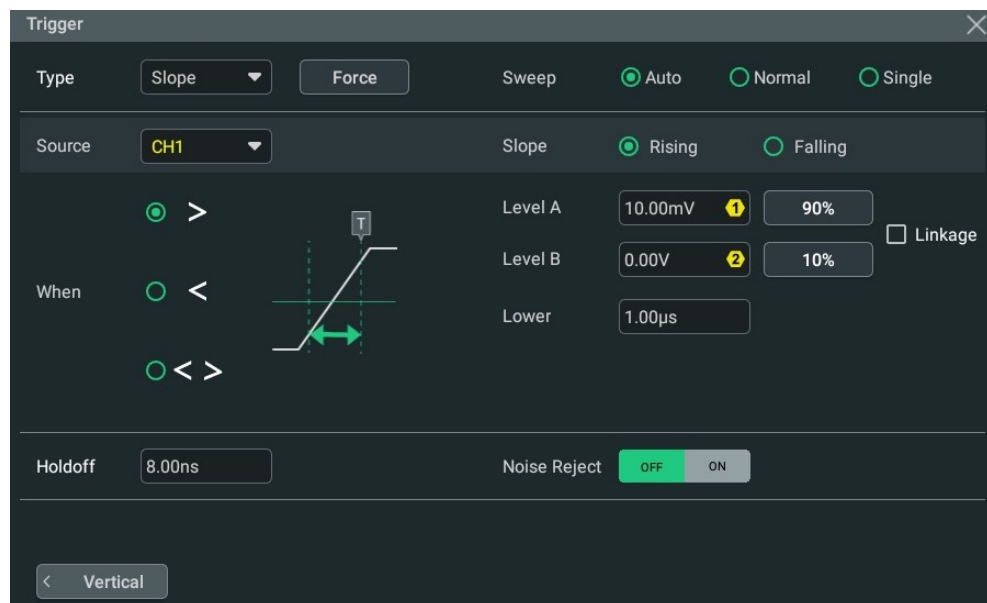

**Figure 8.7 Slope Trigger Setting Menu**

After a trigger type is selected, the current trigger setting information (including trigger type, trigger source, and trigger level) is displayed in the trigger information label at the top of the screen, as shown in the figure below. The information will change based on the trigger settings.

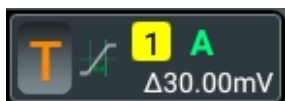

### Source Selection

Click or tap the **Source** drop-down button to select CH1-CH4. For details, refer to *Trigger Source*. The selected trigger source is indicated in the trigger information label at the top of the screen.

Only when you select the channel that has been input with signals as the trigger source, can you obtain a stable trigger.

### Edge Type

Select the input signal edge (in the **Slope** item) on which the oscilloscope triggers.

- Rising: triggers on the rising edge of the input signal.
- Falling: triggers on the falling edge of the input signal.

### Trigger Condition

Set the trigger condition in the **When** item.

- When you select "Rising" for the edge type, ">" for trigger condition, the oscilloscope triggers when the positive slope time of the input signal is greater than the specified time.
- When you select "Rising" for the edge type, "<" for trigger condition, the oscilloscope triggers when the positive slope time of the input signal is smaller than the specified time.
- When you select "Rising" for the edge type, "< >" for trigger condition, the oscilloscope triggers when the positive slope time of the input signal is greater than the specified lower limit time and smaller than the specified upper limit time.
- When you select "Falling" for the edge type, ">" for trigger condition, the oscilloscope triggers when the negative slope time of the input signal is greater than the specified time.
- When you select "Falling" for the edge type, "<" for trigger condition, the oscilloscope triggers when the negative slope time of the input signal is smaller than the specified time.
- When you select "Falling" for the edge type, "< >" for trigger condition, the oscilloscope triggers when the negative slope time of the input signal is greater than the specified lower limit time and smaller than the specified upper limit time.

### Slope Time Setting

- In the **When** item, when ">" or "<" is set to trigger conditions, click or tap the input field of **Lower** or **Upper** to set the lower limit value or the upper limit value with the pop-up numeric keypad. You can also use the corresponding knob to set the value. The slope time available is from 1 ns to 10 s.

- In the **When** item, when "< >" is set to trigger conditions, click or tap the input field of **Upper** and **Lower** respectively to set the upper limit value and the lower limit value with the pop-up numeric keypad. You can also use the corresponding knob to set the values. The lower slope time limit must be smaller than the upper slope time limit.

### Level Selection and Setting

After the trigger condition setting is completed, you need to adjust the trigger level to properly trigger the signal and obtain a stable waveform.

Click or tap the **Level A/Level B** input field to set the level A/level B with the pop-up numeric keypad. You can also use the trigger level knob or specified multifunction knob to adjust level A/level B. Check the checkbox of **Linkage** to link Level A and Level B. The Level A and Level B will be adjusted synchronously. The upper limit and lower limit values change at the same time. The difference between upper and lower limit remains unchanged. For details, refer to descriptions in *Trigger Level*. The current trigger level is displayed in the trigger information label at the top of the screen.



#### TIP

Press down the trigger level knob and rotate it to adjust Level A, Level B, and Level AB (when linkage is enabled) in sequence.

## 8.7.4 Video Trigger

The video signal can include image information and timing information, which adopts different standards and formats. This series can trigger on the standard video signal field or line of NTSC (National Television Standards Committee), PAL (Phase Alternating Line), or SECAM (Sequential Couleur A Memoire).

### Trigger Type

Click or tap the drop-down button of **Type** to select "Video".

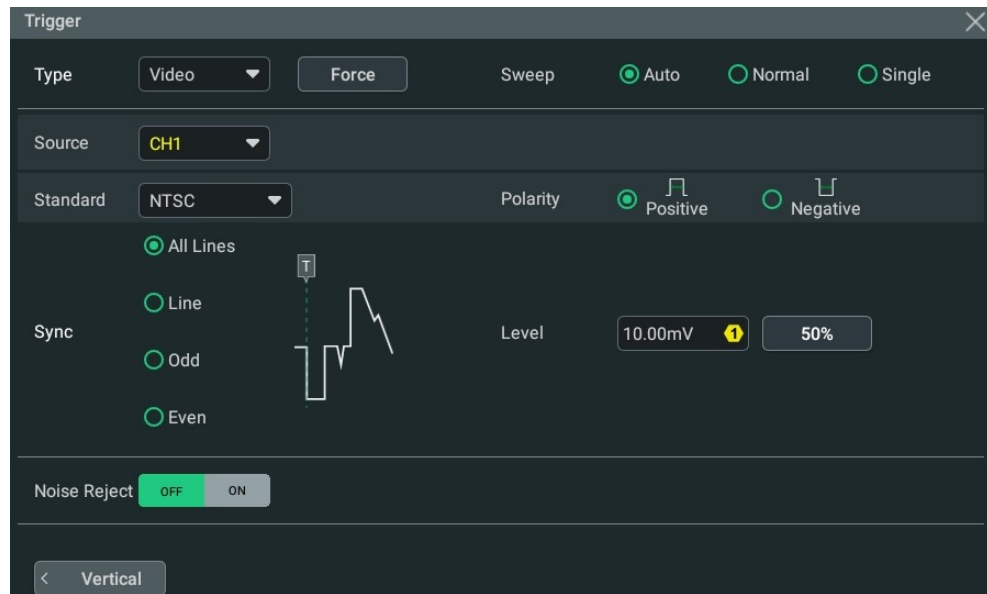

**Figure 8.8 Video Trigger Setting Menu**

After a trigger type is selected, the current trigger setting information (including trigger type, trigger source, and trigger level) is displayed in the trigger information label at the top of the screen, as shown in the figure below. The information will change based on the trigger settings.





### Source Selection

Click or tap the **Source** drop-down button to select CH1-CH4. For details, refer to [Trigger Source](#). The selected trigger source is indicated in the trigger information label at the top of the screen.

Only when you select the channel that has been input with signals as the trigger source, can you obtain a stable trigger.

### Video Polarity

In the **Polarity** item, select the desired polarity: positive polarity () or negative polarity ()

### Video Standard

Click or tap the drop-down button of **Standard** to select the desired video standard.

Table 8.1 Video Standard

Video Standard	Frame Frequency (Frame)	Scan Type	TV Scan Line
NTSC	30	Interlaced Scan	525
PAL/SECAM	25	Interlaced Scan	625
480p/60Hz	60	Progressive Scan	525
576p/50Hz	50	Progressive Scan	625
720p/60Hz	60	Progressive Scan	750
720p/50Hz	50	Progressive Scan	750
720p/30Hz	30	Progressive Scan	750
720p/25Hz	25	Progressive Scan	750
720p/24Hz	24	Progressive Scan	750
1080p/60Hz	60	Progressive Scan	1125
1080p/50Hz	50	Progressive Scan	1125
1080p/30Hz	30	Progressive Scan	1125
1080p/25Hz	25	Progressive Scan	1125
1080p/24Hz	24	Progressive Scan	1125
1080i/60Hz	60	Interlaced Scan	1125
1080i/50Hz	50	Interlaced Scan	1125

### Sync

In the **Sync** item, select the desired sync type.

- All Lines: triggers on the first line found.
- Line: triggers on the specified line.

When this sync type is selected, you can specify a line number. Click or tap the input field of **Line** to set the line number by using the pop-up numeric keypad. You can also use the corresponding multifunction knob to set the value. The range of the line number is related to the currently selected video standards. The range is from 1 to 525 (NTSC), 1 to 625 (PAL/SECAM), 1 to 525 (480p), 1 to 625 (576p), 1 to 750 (720p), or 1 to 1125 (1080p/1080i).

- Odd: triggers on the rising edge of the first ramp pulse in the odd field. It is only available when the video standard is set to "NTSC" or "PAL/SECAM".
- Even: triggers on the rising edge of the first ramp pulse in the even field. It is only available when the video standard is set to "NTSC" or "PAL/SECAM".

### TIP

- To better observe the waveform details in the video signal, you can set a larger memory depth first.
- In the trigger debugging process of video signals, the frequency in different part of the signal can be reflected by a different brightness, as RIGOL's digital oscilloscope provides



the intensity graded color display function. Experienced users can quickly judge the signal quality and discover abnormalities during the debugging process.

### 8.7.5 Pattern Trigger

The pattern trigger identifies a trigger condition by looking for a specified pattern. This pattern is a logical "AND" combination of channels. Each channel can be set to H (high), L (low), or X (don't care). A rising or falling edge (you can only specify a single edge) can be specified for one channel included in the pattern. When an edge is specified, the oscilloscope will trigger at the edge specified if the pattern set for the other channels are true (namely the actual pattern of the channel is the same as the preset pattern). If no edge is specified, the oscilloscope will trigger on the last edge that makes the pattern true. If all the channels in the pattern are set to "X", the oscilloscope will not trigger.

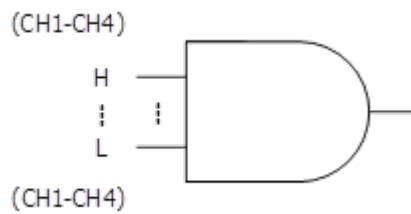

Figure 8.9 Pattern Trigger

#### Trigger Type

Click or tap the **Type** drop-down button to select "Pattern".

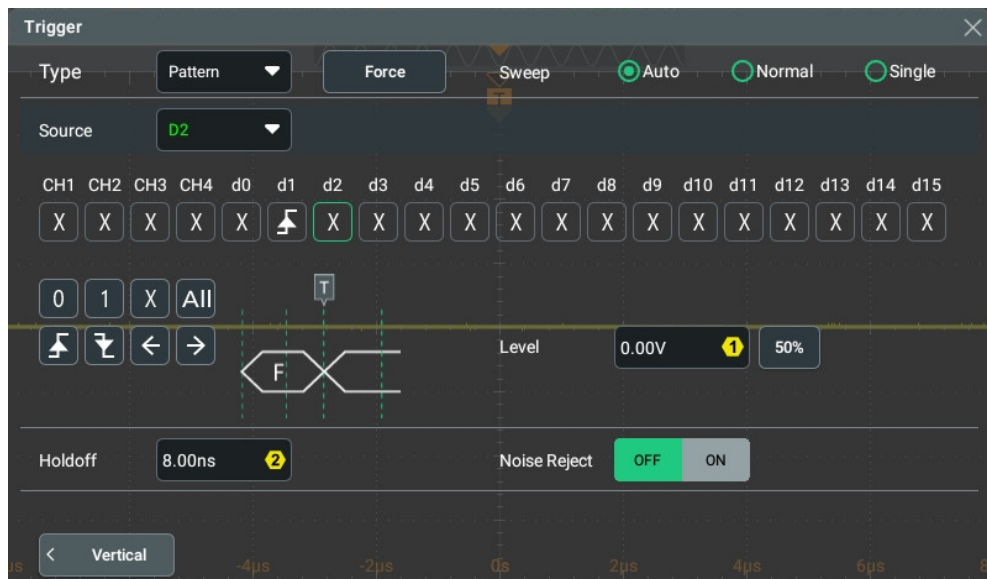

Figure 8.10 Pattern Trigger Setting Menu

After a trigger type is selected, the current trigger setting information (including the trigger type, source, and level) is displayed in the trigger information label at the top of the screen, as shown in the figure below. The information will change based on the trigger settings.





### Source Selection

Click or tap the **Source** drop-down button to select CH1-CH4 or D0-D15. For details, refer to *Trigger Source*. The selected trigger source is indicated in the trigger information label at the top of the screen.

Only when you select the channel that has been input with signals as the trigger source, can you obtain a stable trigger.

### Pattern Setting

The following five patterns are available:

- 1: sets the pattern of the channel selected to "1", i.e. the voltage level is higher than the trigger level of the channel.
- 0: sets the pattern of the channel selected to "0", i.e. the voltage level is lower than the trigger level of the channel.
- X: sets the pattern of the channel selected to "X", i.e. this channel is not used as a part of the pattern. When all channels in the pattern are set to "X", the oscilloscope will not trigger.
- : sets the pattern to the rising edge of the channel selected.
- : sets the pattern to the falling edge of the channel selected.

The Left/Right arrow key indicates moving left/right to switch the channel pattern. "All" indicates all bits. Select a pattern for a channel and then click or tap **All**. The patterns of all the other channels will be set to the currently selected pattern. The pattern setting is shown in the figure below:

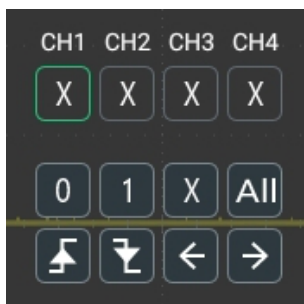

Only one edge (rising or falling edge) can be specified in the pattern. If one edge item is currently defined and then another edge item is defined in another channel in the pattern, then a prompt message "Invalid Input" is displayed.

## 8.7.6 Duration Trigger

In duration trigger, the oscilloscope identifies a trigger condition by searching for the duration of a specified pattern. This pattern is a logical "AND" combination of the channels. Each channel can be set to 1 (high), 0 (low), or X (don't care). The instrument triggers when the duration ( $\Delta T$ ) of this pattern meets the preset time, as shown in the figure below.

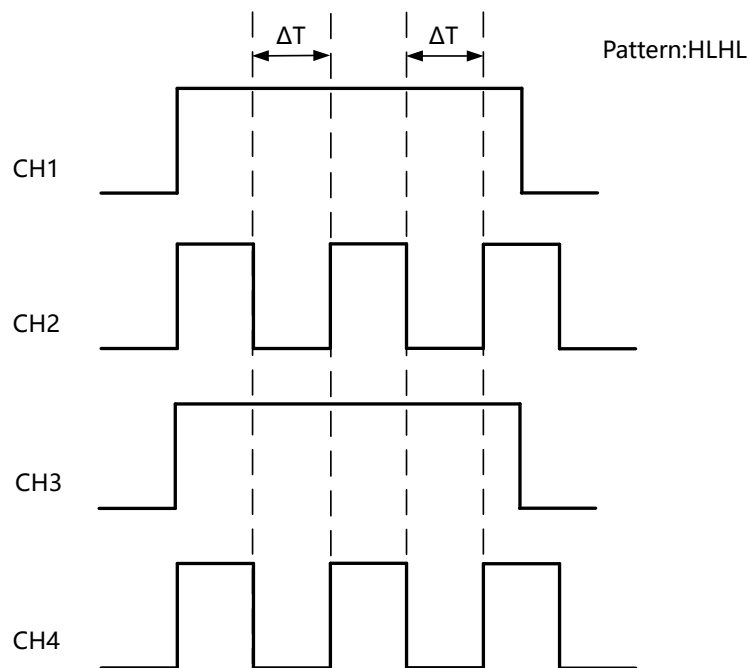
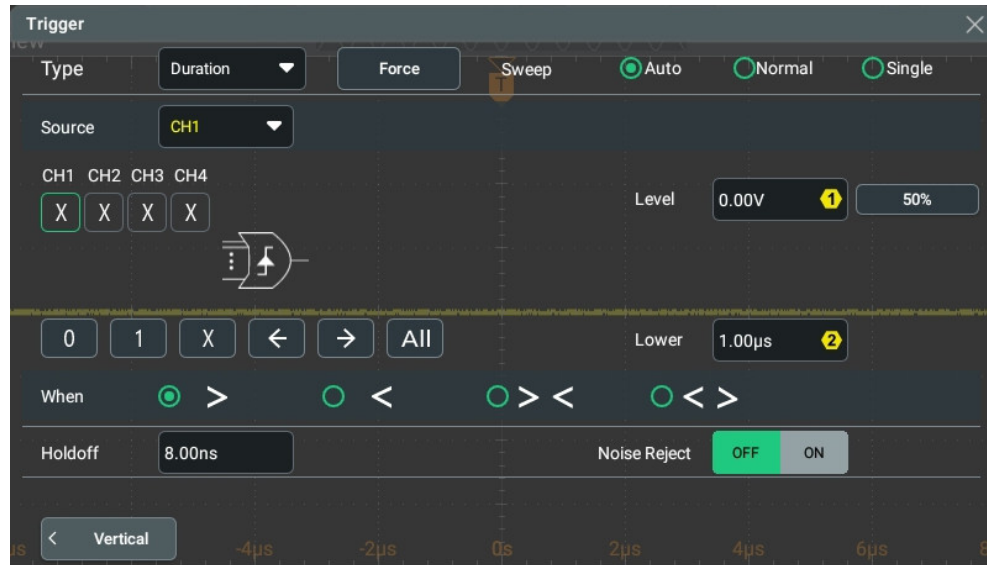

Figure 8.11 Duration Trigger

### Trigger Type

Click or tap the drop-down button of **Type** to select "Duration".



**Figure 8.12 Duration Trigger Setting Menu**

After a trigger type is selected, the current trigger setting information (including the trigger type, source, and level) is displayed in the trigger information label at the top of the screen, as shown in the figure below. The information will change based on the trigger settings.

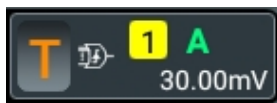

### Source Selection

Click or tap the **Source** drop-down button to select CH1-CH4 or D0-D15. For details, refer to *Trigger Source*. The selected trigger source is indicated in the trigger information label at the top of the screen.

Only when you select the channel that has been input with signals as the trigger source, can you obtain a stable trigger.

### Pattern Setting

The following three patterns are available:

- 1: sets the pattern of the channel selected to "1", i.e. the voltage level is higher than the trigger level of the channel.
- 0: sets the pattern of the channel selected to "0", i.e. the voltage level is lower than the trigger level of the channel.
- X: sets the pattern of the channel selected to "X", i.e. this channel is not used as a part of the pattern. When all channels in the pattern are set to "X", the oscilloscope will not trigger.

The Left/Right arrow key indicates moving left/right to switch the channel pattern. "All" indicates all bits. Select a pattern for a channel and then click or tap **All**. The patterns of all the other channels will be set to the currently selected pattern.

### Trigger Condition

Set the trigger condition in the **When** item.

- **>**: triggers when the duration of the pattern is greater the preset time. Click or tap the input field of **Lower** to set the lower limit of the duration of the pattern with the pop-up numeric keypad. You can also use the corresponding multifunction knob to set the value. The available range is from 1 ns to 10 s.
- **<**: triggers when the duration of the pattern is smaller than the preset time. Click or tap the input field of **Upper** to set the upper limit of the duration of the pattern. You can also use the corresponding multifunction knob to set the value. The available range is from 1 ns to 10 s.
- **< >**: triggers when the duration of the pattern is smaller than the upper limit of the preset time and greater than the lower limit of the preset time. Click or tap the input field of **Upper** to set the upper limit of the duration of the pattern. Click or tap the input field of **Lower** to set the lower limit of the duration of the pattern. You can also use the corresponding multifunction knob to set the upper/lower limit. The range of the upper limit is from 1 ns to 10 s, and the rang of the lower limit is from 1 ns to 9.9 s. The lower time limit must be smaller than the upper time limit.
- **> <**: triggers when the duration of the pattern is greater than the upper limit of the preset time or smaller than the lower limit of the preset time. Click or tap the input field of **Upper** to set the upper limit of the duration of the pattern. Click or tap the input field of **Lower** to set the lower limit of the duration of the pattern. You can also use the corresponding multifunction knob to set the upper/lower limit. The range of the upper limit is from 1 ns to 10 s, and the range of the lower limit is from 1 ns to 9.9 s. The lower time limit must be smaller than the upper time limit.

## 8.7.7 Timeout Trigger

In Timeout trigger, the oscilloscope triggers when the time interval ( $\Delta T$ ) (the time from when the rising edge (or falling edge) of the input signal passes through the trigger level to the time from when the neighboring falling edge (or rising edge) passes through the trigger level) is greater than the preset timeout value, as shown in the figure below.

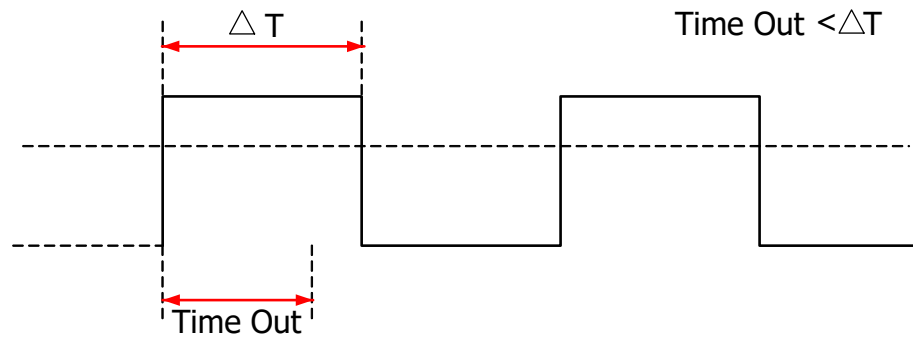

Figure 8.13 Timeout Trigger

### Trigger Type

Click or tap the drop-down button of **Type** to select "Timeout".

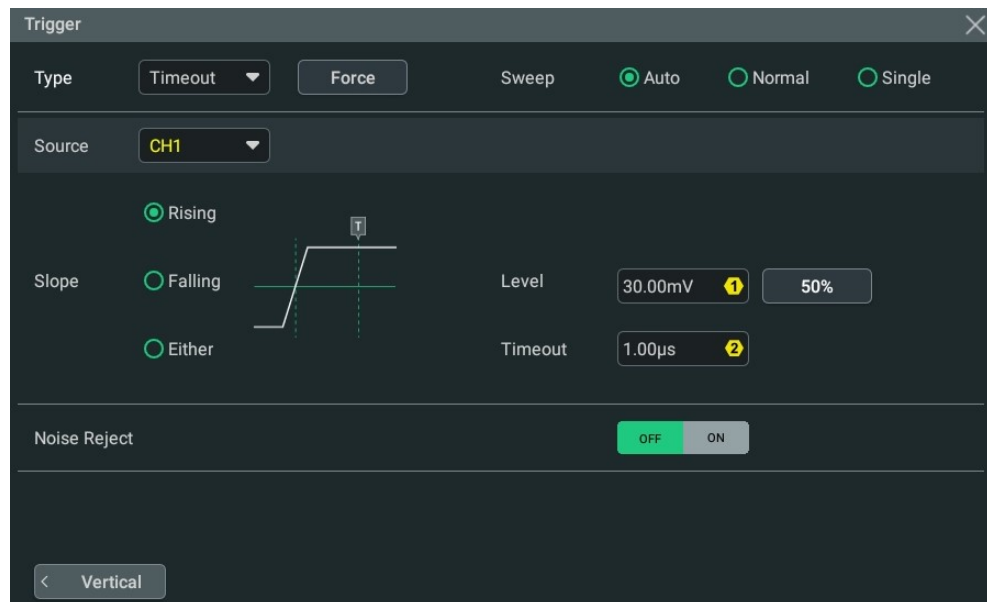
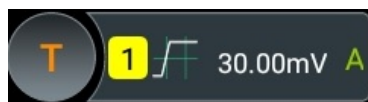

Figure 8.14 Timeout Trigger Menu

After a trigger type is selected, the current trigger setting information (including the trigger type, source, and level) is displayed in the trigger information label at the top of the screen, as shown in the figure below. The information will change based on the trigger settings.



### Source Selection

Click or tap the **Source** drop-down button to select CH1-CH4 or D0-D15. For details, refer to *Trigger Source*. The selected trigger source is indicated in the trigger information label at the top of the screen.

Only when you select the channel that has been input with signals as the trigger source, can you obtain a stable trigger.

### Edge Type

In **Slope** item, select the edge type from which the input signal passes through the trigger level.

- Rising: starts timing when the rising edge of the input signal passes through the trigger level.
- Falling: starts timing when the falling edge of the input signal passes through the trigger level.
- Either: starts timing when either edge of the input signal passes through the trigger level.

### Timeout Value

Timeout value represents the maximum time that the signal remains idle after the signal passes through the trigger level. Click or tap the input field of **Timeout**, and then use the pop-up numeric keypad to set the timeout value. You can also use the specified multifunction knob to set the value.

## 8.7.8 Runt Trigger

The runt trigger is used to trigger pulses that pass through one trigger level but fail to pass through another trigger level, as shown in the figure below.

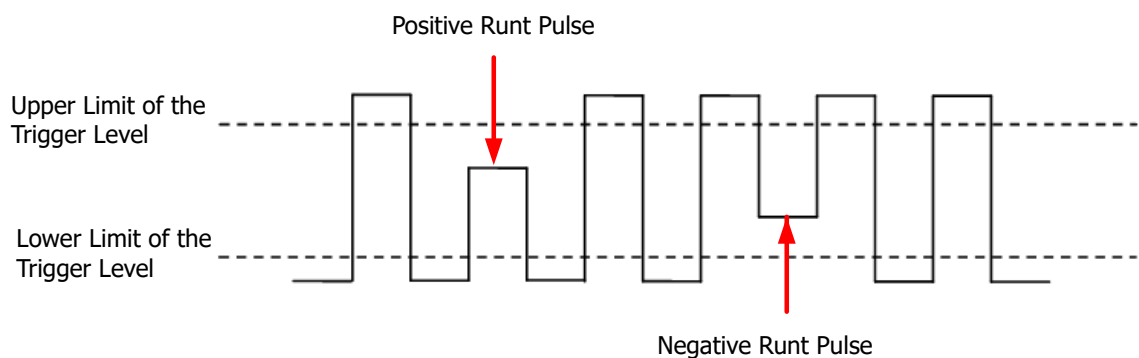
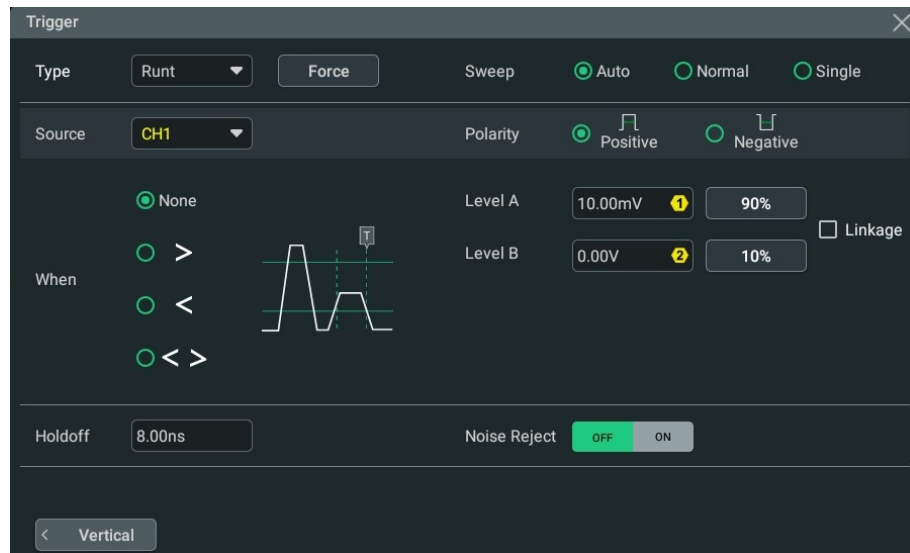

Figure 8.15 Runt Trigger

### Trigger Type

Click or tap the drop-down button of **Type** to select "Runt".



**Figure 8.16 Runt Trigger Setting Menu**

After a trigger type is selected, the current trigger setting information (including the trigger type, source, and level) is displayed in the trigger information label at the top of the screen, as shown in the figure below. The information will change based on the trigger settings.

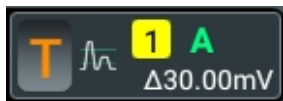



### Source Selection

Click or tap the **Source** drop-down button to select CH1-CH4. For details, refer to [Trigger Source](#). The selected trigger source is indicated in the trigger information label at the top of the screen.

Only when you select the channel that has been input with signals as the trigger source, can you obtain a stable trigger.

### Polarity

Select the pulse polarity of Runt trigger under the **Polarity** item.

- Positive : indicates that the instrument triggers on the positive runt pulse.
- Negative : triggers on the negative runt pulse.

### Trigger Condition

Set the Runt trigger condition in the **When** item.

- **None**: indicates not setting the trigger condition of Runt trigger.

- **>**: triggers when the runt pulse width is greater than Lower limit of pulse width. Click or tap the input field of **Lower** to set the minimum pulse width of Runt trigger with the pop-up numeric keypad. You can also use the corresponding multifunction knob to modify the value.
- **<**: triggers when the runt pulse width is smaller than the upper limit of pulse width. Click or tap the input field of **Upper** to set the maximum pulse width of Runt trigger with the pop-up numeric keypad. You can also use the corresponding multifunction knob to modify the value.
- **< >**: triggers when the runt pulse width is greater than the lower limit and smaller than the upper limit of pulse width. Click or tap the input field of **Upper** to set the maximum pulse width of Runt trigger with the pop-up numeric keypad. Click or tap the input field of **Lower** to set the minimum pulse width of Runt trigger with the pop-up numeric keypad. You can also use the corresponding multifunction knob to modify the maximum and minimum pulse width. The lower limit of the pulse width must be smaller than the upper limit.

### Level Selection and Setting

After the trigger condition setting is completed, you need to adjust the trigger level to properly trigger the signal and obtain a stable waveform.

Click or tap the **Level A/Level B** input field to set the level A/level B with the pop-up numeric keypad. You can also use the trigger level knob or specified multifunction knob to adjust level A/level B. Check the checkbox of **Linkage** to link Level A and Level B. The Level A and Level B will be adjusted synchronously. The upper limit and lower limit values change at the same time. The difference between upper and lower limit remains unchanged. For details, refer to descriptions in *Trigger Level*. The current trigger level is displayed in the trigger information label at the top of the screen.

#### TIP

Press down the trigger level knob and rotate it to adjust Level A, Level B, and Level AB (when linkage is enabled) in sequence.



## 8.7.9 Window Trigger

Window trigger provides a high trigger level and a low trigger level. The instrument triggers when the input signal passes through the high trigger level or the low trigger level.

### Trigger Type

Click or tap the **Type** drop-down button to select "Window".

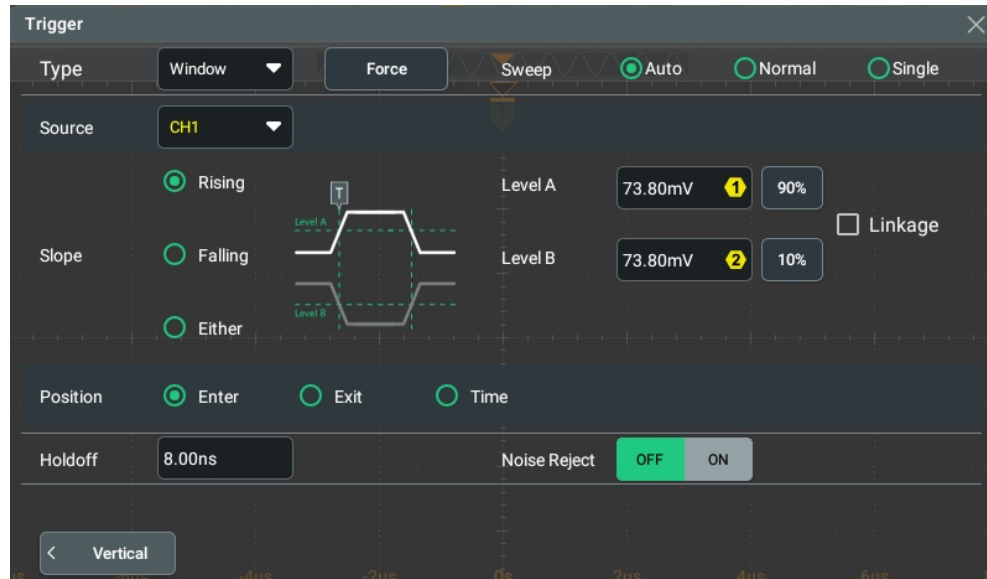

**Figure 8.17 Window Trigger Setting Menu**

After a trigger type is selected, the current trigger setting information (including trigger type, trigger source, and trigger level) is displayed in the trigger information label at the top of the screen, as shown in the figure below. The information will change based on the trigger settings.

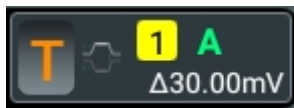

### Source Selection

Click or tap the **Source** drop-down button to select CH1-CH4. For details, refer to *Trigger Source*. The selected trigger source is indicated in the trigger information label at the top of the screen.

Only when you select the channel that has been input with signals as the trigger source, can you obtain a stable trigger.

### Edge Type

Select the input signal edge (in the **Slope** item) on which the oscilloscope triggers.

- Rising: triggers on the rising edge of the input signal when **Position** condition is met.
- Falling: triggers on the falling edge of the input signal when **Position** condition is met.
- Either: triggers on the rising or falling edge of the input signal when **Position** condition is met.

### Trigger Position

After selecting the window type, specify the time point of trigger by selecting the trigger position (in **Position** item).

- **Enter:** triggers when the input signal enters the specified trigger level range.
- **Exit:** triggers when the input signal exits the specified trigger level range.
- **Time:** triggers when the accumulated hold time since the input signal entered the specified trigger level range is equal to the window time. After you select this type, click or tap the input field of Time to set it by using the pop-up numeric keypad. The available range is from 1 ns to 10 s.

### Level Selection and Setting

After the trigger condition setting is completed, you need to adjust the trigger level to properly trigger the signal and obtain a stable waveform.

Click or tap the **Level A/Level B** input field to set the level A/level B with the pop-up numeric keypad. You can also use the trigger level knob or specified multifunction knob to adjust level A/level B. Check the checkbox of **Linkage** to link Level A and Level B. The Level A and Level B will be adjusted synchronously. The upper limit and lower limit values change at the same time. The difference between upper and lower limit remains unchanged. For details, refer to descriptions in *Trigger Level*. The current trigger level is displayed in the trigger information label at the top of the screen.

#### TIP

Press down the trigger level knob and rotate it to adjust Level A, Level B, and Level AB (when linkage is enabled) in sequence.



## 8.7.10 Delay Trigger

In Delay trigger, you need to set Source A and Source B. The oscilloscope triggers when the time difference ( $\Delta T$ ) between the specified edges (Edge A and Edge B) of Source A and Source B meets the preset time limit, as shown in the figure below. See the figure below.

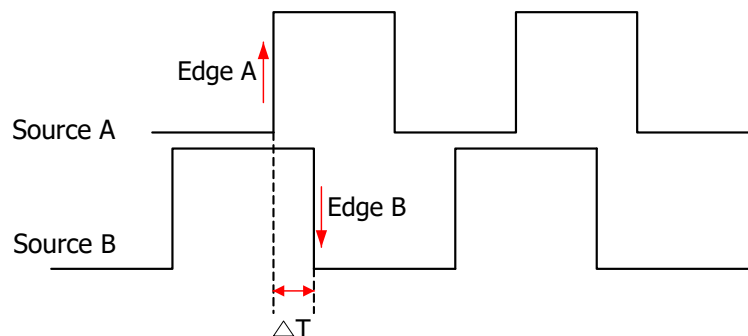
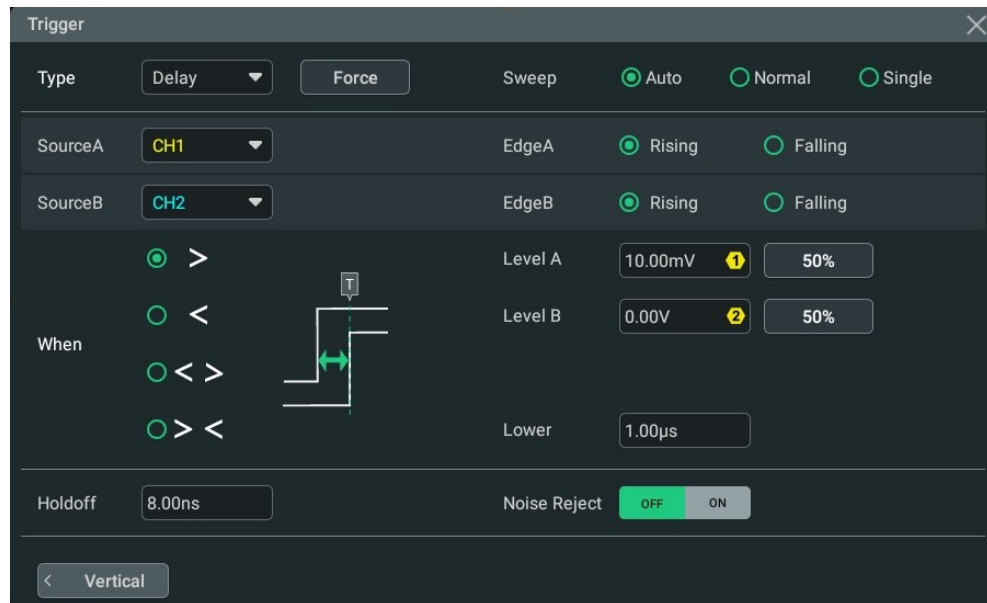

Figure 8.18 Delay Trigger

## Trigger Type

Click or tap the **Type** drop-down button to select "Delay".



**Figure 8.19 Delay Trigger Setting Menu**

After a trigger type is selected, the current trigger setting information (including trigger type, trigger source, and trigger level) is displayed in the trigger information label at the top of the screen, as shown in the figure below. The information will change based on the trigger settings.

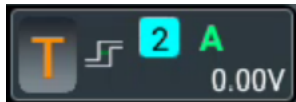

## Source Setting

- **Source A**

Click or tap the drop-down button of **SourceA** to select CH1-CH4 or D0-D15. For details, refer to *Trigger Source*. The selected trigger source is indicated in the trigger information label at the top of the screen.

Only when you select the channel that has been input with signals as the trigger source, can you obtain a stable trigger.

- **Edge A**

Select the trigger edge type ("Rising" or "Falling") of Source A in Delay trigger in **Edge A** item.

- **Source B**

Click or tap the drop-down button of **SourceB** to select CH1-CH4 or D0-D15. For details, refer to *Trigger Source*. The selected trigger source is indicated in the trigger information label at the top of the screen.

Only when you select the channel that has been input with signals as the trigger source, can you obtain a stable trigger.

- **Edge B**

Select the trigger edge type ("Rising" or "Falling") of Source B in Delay trigger in the **EdgeB** item.

### Set the Trigger Condition

Set the time limit condition of Delay trigger in the **when** item.

- **>**: triggers when the time difference ( $\Delta T$ ) between the specified edges of Source A and Source B is greater than the preset time lower limit. Click or tap the input field of **Lower** to set the delay time lower limit in Delay trigger with the pop-up numeric keypad. You can also use the corresponding multifunction knob to set the value.
- **<**: triggers when the time difference ( $\Delta T$ ) between the specified edges of Source A and Source B is smaller than the preset time upper limit. Click or tap the input field of **Upper** to set the delay time upper limit in Delay trigger with the pop-up numeric keypad. You can also use the corresponding multifunction knob to set the value.
- **< >**: triggers when the time difference ( $\Delta T$ ) between the specified edges of Source A and Source B is greater than the lower limit of the preset time and smaller than the upper limit of the preset time. Click or tap the input field of **Upper** to set the delay time upper limit in Delay trigger with the pop-up numeric keypad. Click or tap the input field of **Lower** to set the delay time lower limit in Delay trigger with the pop-up numeric keypad. You can also use the corresponding multifunction knob to set the upper and lower limit. The lower time limit must be smaller than the upper time limit.
- **> <**: triggers when the time difference ( $\Delta T$ ) between the specified edges of Source A and Source B is smaller than the lower limit of the preset time or greater than the upper limit of the preset time. Click or tap the input field of **Upper** to set the delay time upper limit in Delay trigger with the pop-up numeric keypad. Click or tap the input field of **Lower** to set the delay time lower limit in Delay trigger with the pop-up numeric keypad. You can also use the corresponding multifunction knob to set the upper and lower limit. The lower time limit must be smaller than the upper time limit.

### Level Selection and Setting

After the trigger condition setting is completed, you need to adjust the trigger level to properly trigger the signal and obtain a stable waveform.

Click or tap the **Level A/Level B** input field to set the level A/level B with the pop-up numeric keypad. You can also use the corresponding multifunction knob to adjust level A/level B or use the trigger level knob to adjust the level (the focus of the trigger level knob is the last modified level). For details, refer to descriptions in *Trigger Level*. The current trigger level is displayed in the trigger information label at the top of the screen.

### 8.7.11 Setup/Hold Trigger

In setup&hold trigger, you need to set the clock source and data source. The setup time starts when the data signal passes the trigger level and ends at the coming of the specified clock edge; the hold time starts at the coming of the specified clock edge and ends when the data signal crosses the trigger level again, as shown in the figure below. The oscilloscope triggers when the setup time or hold time is smaller than the preset time.

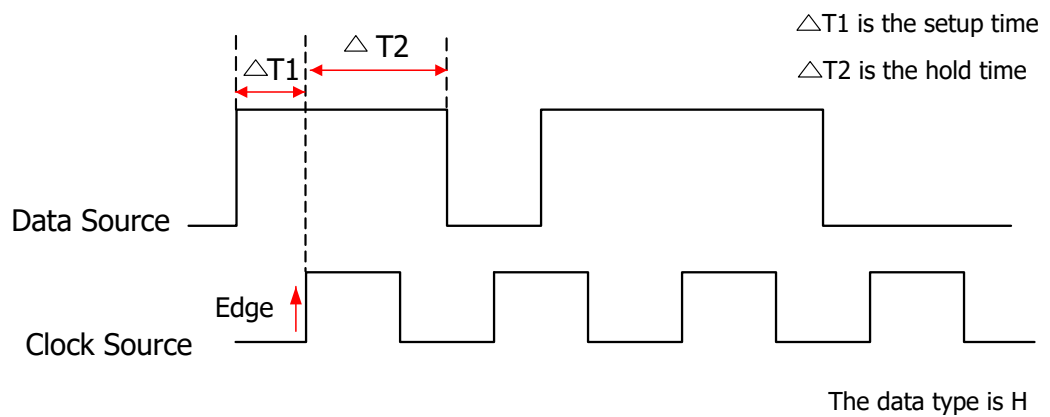
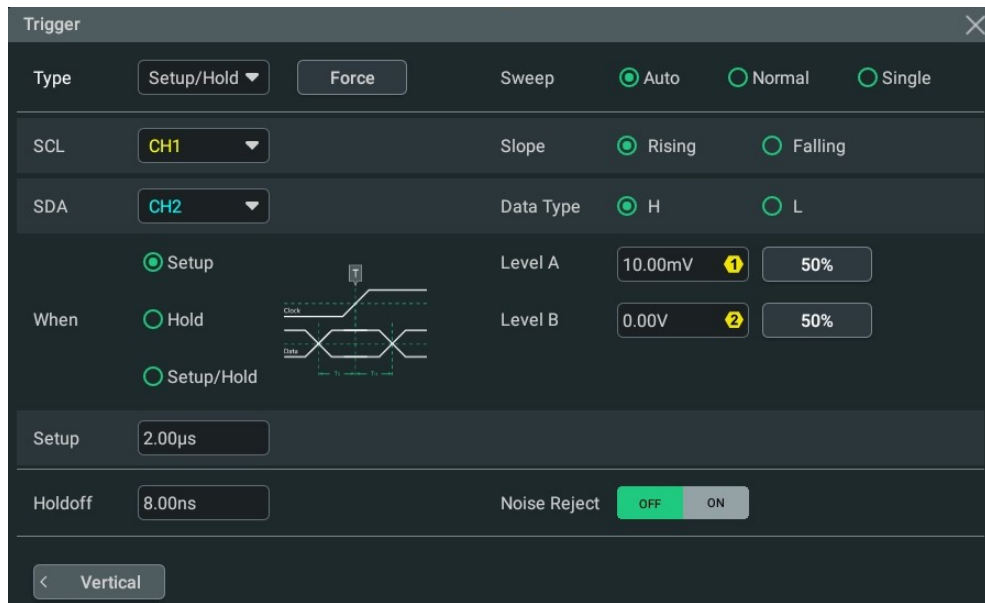

Figure 8.20 Setup/Hold Trigger

#### Trigger Type

Click or tap the drop-down button of **Type** to select "Setup/Hold".



**Figure 8.21 Setup/Hold Trigger Setting Menu**

After a trigger type is selected, the current trigger setting information (including the trigger type, source, and level) is displayed in the trigger information label at the top of the screen, as shown in the figure below. The information will change based on the trigger settings.

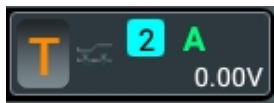

### Clock Source

Click or tap the drop-down button of **SCL** to select CH1-CH4 or D0-D15. For details, refer to *Trigger Source*. The selected trigger source is indicated in the trigger information label at the top of the screen.

Only when you select the channel that has been input with signals as the trigger source, can you obtain a stable trigger.

### Edge Type

Select the desired clock edge type in the **Slope** item, and it can be set to "Rising" or "Falling".

### Data Source

Click or tap the drop-down button of **SDA** to select CH1-CH4 or D0-D15. For details, refer to *Trigger Source*. The selected trigger source is indicated in the trigger information label at the top of the screen.

Only when you select the channel that has been input with signals as the trigger source, can you obtain a stable trigger.

### Data Type

Select the effective pattern of the data signal in the **Data Type** item. It can be set to H (high level) or L (low level).

### Trigger Condition

Set the Setup/Hold trigger condition in the **When** item.

- **Setup:** the oscilloscope triggers when the setup time is smaller than the specified setup time. After selecting this type, click or tap the input field of **Setup** to set the setup time with the pop-up numeric keypad. You can also use the corresponding multifunction knob to set the value.
- **Hold:** the oscilloscope triggers when the hold time is smaller than the specified hold time. After selecting this type, click or tap the input field of **Hold** to set the hold time with the pop-up numeric keypad. You can also use the corresponding multifunction knob to set the value.
- **Setup/Hold:** the oscilloscope triggers when the setup time or hold time smaller than the specified time value. After selecting this type, click or tap the input field of **Setup** and **Hold** respectively to set the setup and hold time with the pop-up numeric keypad. You can also use the corresponding multifunction knob to set the values.

### Level Selection and Setting

After the trigger condition setting is completed, you need to adjust the trigger level to properly trigger the signal and obtain a stable waveform.

Click or tap the **Level A/Level B** input field to set the level A/level B with the pop-up numeric keypad. You can also use the corresponding multifunction knob to adjust level A/level B or use the trigger level knob to adjust the level (the focus of the trigger level knob is the last modified level). For details, refer to descriptions in *Trigger Level*. The current trigger level is displayed in the trigger information label at the top of the screen.

## 8.7.12 Nth Edge Trigger

Triggers on the Nth edge that appears after the specified idle time. For example, in the waveform as shown in the figure below, the instrument should trigger on the second rising edge after the specified idle time (the time between two neighboring rising edges), and the idle time should be within the range between P and M ( $P < \text{Idle Time} < M$ ). Wherein, M is the time between the first rising edge and its previous rising edge; P is the maximum time between the rising edges that participate in counting.

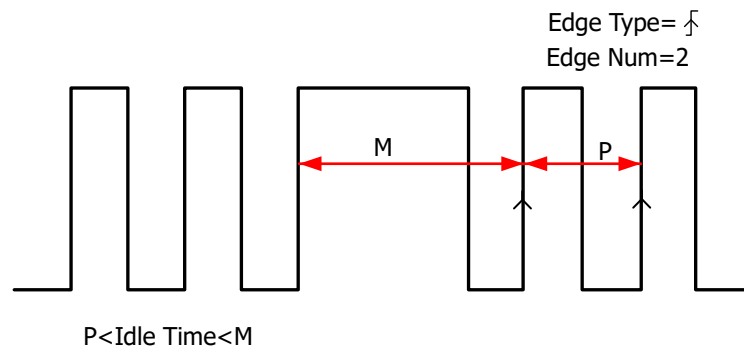

Figure 8.22 Nth Edge Trigger

### Trigger Type

Click or tap the drop-down button of **Type** to select "Nth Edge".

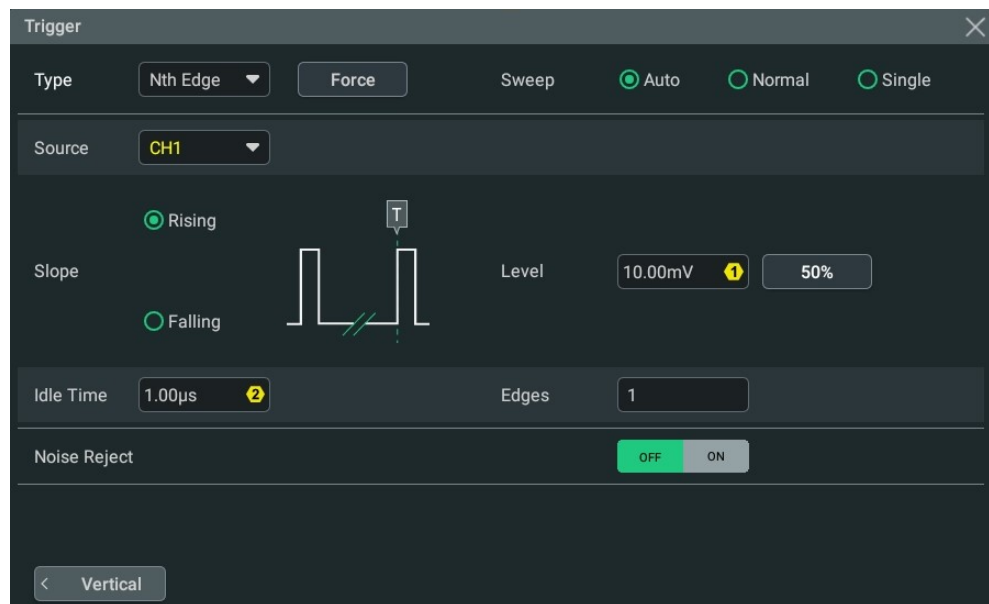

Figure 8.23 Nth Edge Trigger Setting Menu

After a trigger type is selected, the current trigger setting information (including trigger type, trigger source, and trigger level) is displayed in the trigger information label at the top of the screen, as shown in the figure below. The information will change based on the trigger settings.



### Source Selection

Click or tap the **Source** drop-down button to select CH1-CH4 or D0-D15. For details, refer to *Trigger Source*. The selected trigger source is indicated in the trigger information label at the top of the screen.

Only when you select the channel that has been input with signals as the trigger source, can you obtain a stable trigger.

### Edge Type

Select the input signal edge (in the **Slope** item) on which the oscilloscope triggers.

- Rising: triggers on the rising edge of the input signal when the voltage level meets the specified trigger level.
- Falling: triggers on the falling edge of the input signal when the voltage level meets the specified trigger level.

### Idle Time

Click or tap the input field of **Idle Time**, and then use the pop-up numeric keypad to set the idle time before the edge counting in Nth edge trigger. You can also use the corresponding multifunction knob to set the value.

### Edge Count

Click or tap the input field of **Edges**, then use the pop-up numeric keypad to set the value of "N" in Nth edge trigger. You can also use the corresponding multifunction knob to set the value. The available range is from 1 to 65,535.

## 8.7.13 RS232 Trigger

RS232 bus is a serial communication mode used in data transmission between PCs or between a PC and a terminal. In RS232 serial protocol, a character is transmitted as a frame of data. The frame consists of 1 start bit, 5-8 data bits, 1 check bit, and 1-2 stop bits. Its format is as shown in the figure below. This series oscilloscope triggers when the start frame, error frame, check error, or the specified data of the RS232 signal is detected.

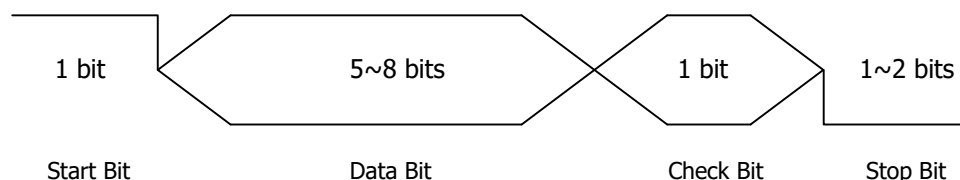

**Figure 8.24 Schematic Diagram of RS232 Protocol**

## Trigger Type

Click or tap the drop-down button of **Type** to select "RS232".

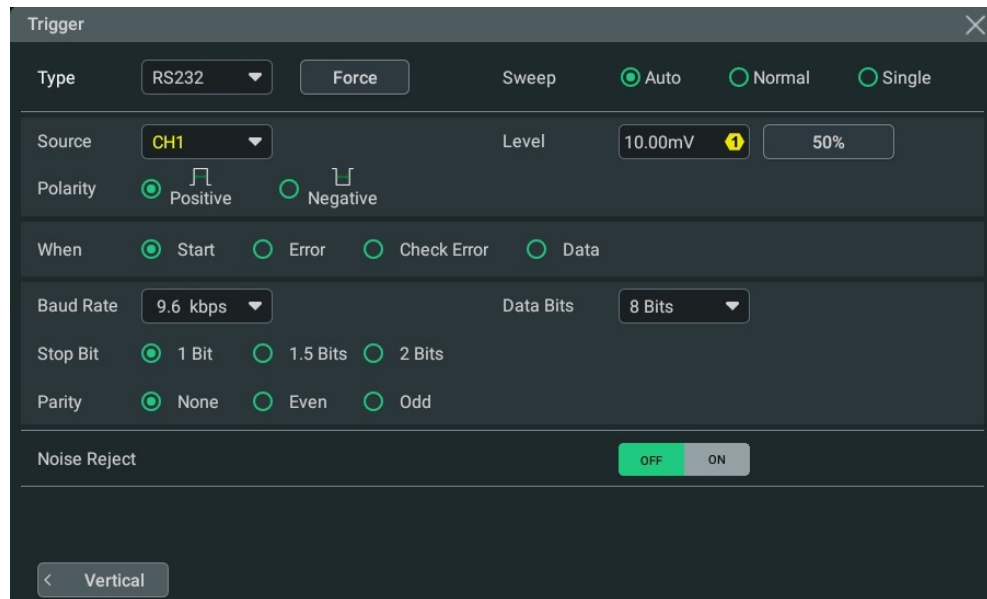

**Figure 8.25 RS232 Trigger Setting Menu**

After a trigger type is selected, the current trigger setting information (including the trigger type, source, and level) is displayed in the trigger information label at the top of the screen, as shown in the figure below. The information will change based on the trigger settings.

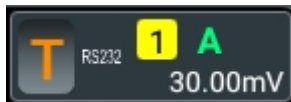

### Source Selection

Click or tap the **Source** drop-down button to select CH1-CH4 or D0-D15. For details, refer to *Trigger Source*. The selected trigger source is indicated in the trigger information label at the top of the screen.

Only when you select the channel that has been input with signals as the trigger source, can you obtain a stable trigger.

### Polarity

Select the polarity of data transmission in the **Polarity** item. It can be set to "Positive"



### Trigger Condition

Set the desired trigger condition in the **When** item.

- **Start:** triggers on the start frame position.
- **Error:** triggers when an error frame is detected.
- **Check Error:** triggers when a check error is detected.
- **Data:** triggers on the last bit of the preset data bits. Click or tap the input field of **Data**, and then use the pop-up numeric keypad to set the data of RS232 trigger. You can also use the corresponding multifunction knob to set the value.

### Baud Rate

You can select the baud rate of data transmission (i.e. specifies a clock frequency). Click or tap the drop-down button of **Baud Rate**, then select the preset baud rate. The available baud rates include 50 bps, 75 bps, 110 bps, 134 bps, 150 bps, 300 bps, and etc. You can also self-define the baud rate.

### Data Bits

Indicates the number of bits per frame. Click or tap the drop-down button of **Data Bits** to select the desired data bits. The available data bits include "5 Bits", "6 Bits", "7 Bits", and "8 Bits".

### Stop Bit

Indicates when to stop outputting data. Select the desired stop bit in the **Stop Bit** item. The available data bits include 1 Bit, 1.5 Bits, and 2 Bits.

### Parity

Used to check whether the data are properly transmitted. Select None, Even, or Odd in the **Parity** item.

- **None:** indicates that no check bit appears during the transmission.
- **Even:** indicates that the total number of "1" in the data bit and check bit is an even number. For example, when 0x55 (01010101) is sent, "0" should be added to the check bit.
- **Odd:** indicates that the total number of "1" in the data bit and check bit is an odd number. For example, when 0x55 (01010101) is sent, "1" should be added to the check bit.

## 8.7.14 I2C Trigger

I2C is a 2-wire serial bus used to connect the microcontroller and its peripheral device. It is a bus standard widely used in the microelectronic communication control field.

The I2C serial bus consists of SCL and SDA. Its transmission rate is determined by SCL, and its transmission data is determined by SDA, as shown in the figure below. The instrument triggers on the start condition, restart, stop, missing acknowledgment,

specific device address, or data value. Besides, it can also trigger on the specific device address and data values at the same time.

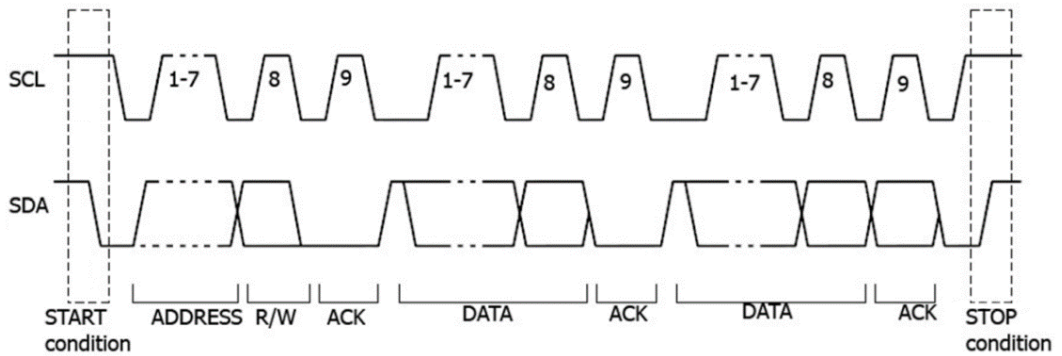

Figure 8.26 Sequential Chart of I2C Bus

### Trigger Type

Click or tap the drop-down button of **Type** to select "I2C".

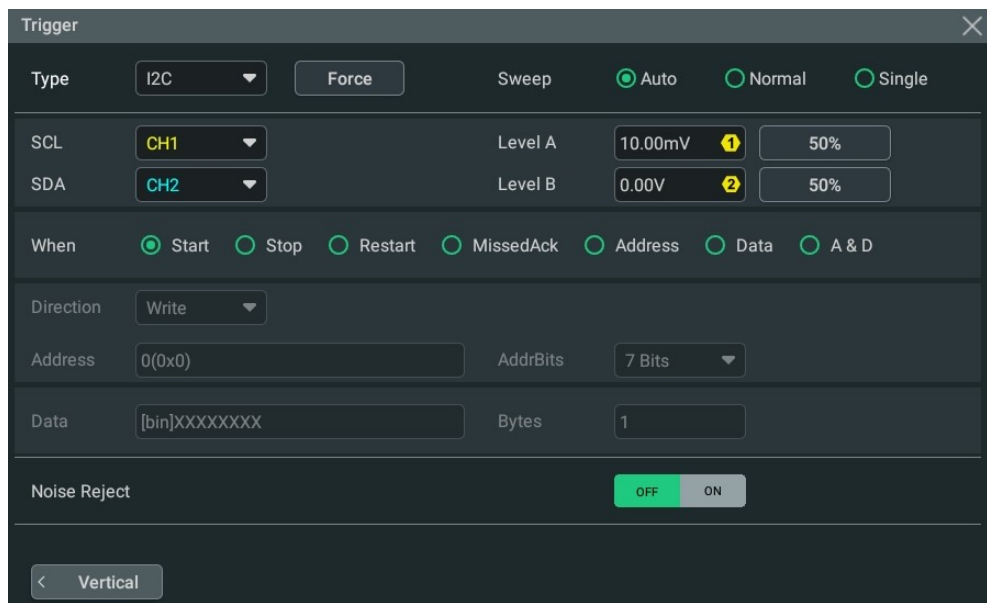
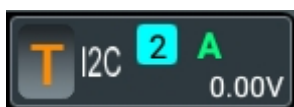

Figure 8.27 I2C Trigger Setting Menu

After a trigger type is selected, the current trigger setting information (including the trigger type, source, and level) is displayed in the trigger information label at the top of the screen, as shown in the figure below. The information will change based on the trigger settings.



## Source Selection

Click or tap the drop-down buttons of **SCL** and **SDA** to select CH1-CH4 or D0-D15 to specify the sources of SCL and SDA respectively. For details, refer to descriptions in *Trigger Source*. The selected trigger source is indicated in the trigger information label at the top of the screen.

Only when you select the channel that has been input with signals as the trigger source, can you obtain a stable trigger.

## Trigger Condition

Set the desired trigger condition in the **When** item.

- **Start:** triggers when SDA data transitions from high level to low level while SCL is high level.
- **Stop:** triggers when SDA data transitions from low level to high level while SCL is high level.
- **Restart:** triggers when another start condition occurs before a stop condition.
- **MissedAck:** triggers when ACK is 1.
- **Address:** the trigger searches for the specified address value. When this event occurs, the oscilloscope will trigger on the read/write bit. After this trigger condition is selected:
  - Click or tap the drop-down button of **Direction** to select Write, Read, or R/W.  
This setting is not available when **AddrBits** is set to "8 Bits".
  - Click or tap the drop-down button of **AddrBits** to select the desired address bits. The available address bits are "7 Bits", "8 Bits", and "10 Bits".
  - Click or tap the input field of **Address**, and then use the pop-up numeric keypad to set the address of I2C trigger. You can also use the corresponding multifunction knob to set the value.
- **Data:** the trigger searches for the specified data value on the data line (SDA). When this event occurs, the oscilloscope will trigger on the clock line (SCL) transition edge of the last bit of data. After selecting Data as the trigger condition, you can set the address bits, bytes, and data.
  - Click or tap the drop-down button of **AddrBits** to select the desired address bits. The available address bits are "7 Bits", "8 Bits", and "10 Bits".
  - Click or tap the input field of **Bytes**, and then use the pop-up numeric keypad to set the length of the data. You can also use the corresponding multifunction knob to set the value. Its range is from 1 to 5.
  - Click or tap the input field of **Data**, and then the "Format" interface is will displayed. You can select "Bin" or "Hex" data format.

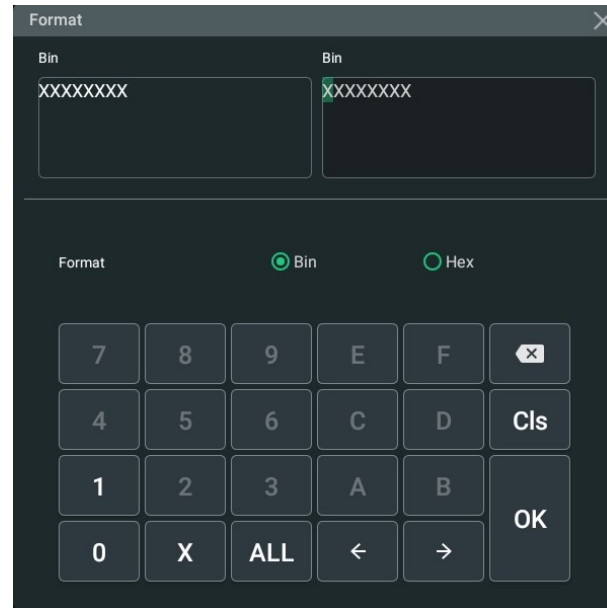

Figure 8.28 Binary Format Setting

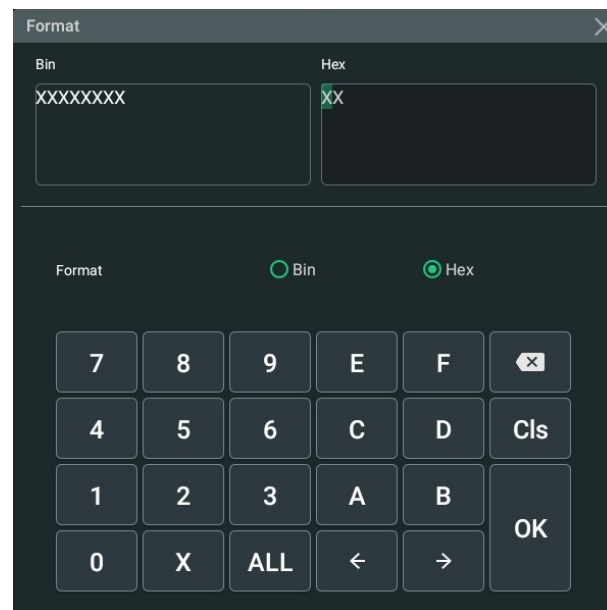

Figure 8.29 Hex Format Setting

- **A&D:** the oscilloscope searches for the specified address and data at the same time, then triggers when both the address and data meet the conditions. After this condition is selected, you need to set the sub Data-menu items such as **Direction**, **Bytes**, **AddrBits**, **Address**, and **Data**. For the setting methods, refer to descriptions in "Address" and "Data" conditions.

### Level Selection and Setting

After the trigger condition setting is completed, you need to adjust the trigger level to properly trigger the signal and obtain a stable waveform.

- **Level A**

Click or tap the input field of **Level A** to input the level of SCL with the pop-up numeric keypad. You can also use the corresponding multifunction knob to set the value. When the level A information is displayed in the trigger label, you can also use the trigger level knob to adjust the level of SCL. For details, refer to descriptions in *Trigger Level*.

- **Level B**

Click or tap the input field of **Level B** to input the level of SDA with the pop-up numeric keypad. You can also use the corresponding multifunction knob to set the value. When the level B information is displayed in the trigger label, you can also use the trigger level knob to adjust the level of SDA. For details, refer to descriptions in *Trigger Level*.

## 8.7.15 SPI Trigger

In SPI trigger, after the CS or timeout condition is satisfied, the oscilloscope triggers when the specified data is found. When using SPI trigger, you need to specify the CLK clock sources and MISO data sources.

The figure below shows the sequential chart of SPI bus.

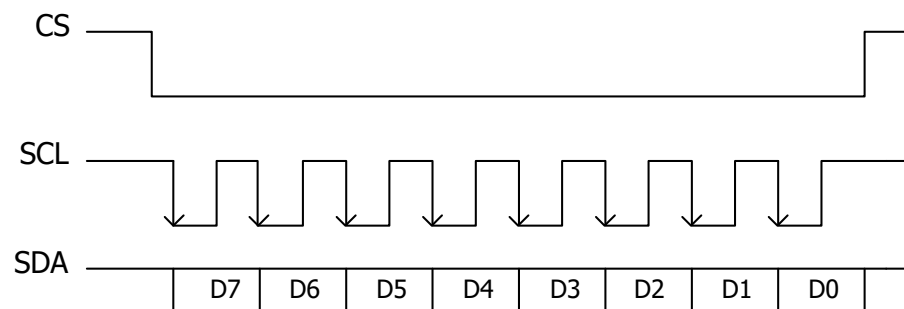

**Figure 8.30 Sequential Chart of SPI Bus**

### Trigger Type

Click or tap the drop-down button of **Type** to select "SPI".



**Figure 8.31 SPI Trigger Setting Menu**

After a trigger type is selected, the current trigger setting information (including trigger type, trigger source, and trigger level) is displayed in the trigger information label at the top of the screen, as shown in the figure below. The information will change based on the trigger settings.

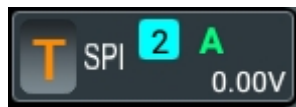

### Source Selection

Click or tap the drop-down buttons of **CLK** and **MISO** to select CH1-CH4 or D0-D15 to specify the sources of CLK and MISO respectively. For details, refer to descriptions in *Trigger Source*. The selected trigger source is indicated in the trigger information label at the top of the screen.

Only when you select the channel that has been input with signals as the trigger source, can you obtain a stable trigger.

### Edge Type

Select the desired clock edge type in **Slope**.

- Rising: samples the MISO data on the rising edge of the clock.
- Falling: samples the MISO data on the falling edge of the clock.

### Trigger Condition

Select the desired trigger condition in **When**.

- With CS: if the CS signal is valid, the oscilloscope will trigger when the data (SDA) satisfying the trigger conditions is found.
  - Click or tap the drop-down button of **CS** to select CH1-CH4 or D0-D15 as the CS signal line.
  - After selecting this condition, you can click or tap "Positive" (high level is valid) or "Negative" (low level is valid) in **CS Mode**.
- Timeout: the oscilloscope starts to search for the data (MISO) on which to trigger after the clock signal (CLK) stays in the idle state for a specified period of time. After selecting this condition, you can click or tap the **Timeout** input field, then use the numeric keypad to set the idle time. You can also use the corresponding multifunction knob to set the value. The range is from 8 ns to 10 s.

### Data

Click or tap the input field of **Data**, and then the "Format" interface is displayed. You can set the data bit that needs to be triggered. For details, refer to descriptions in *I2C Trigger*.

### Data Bits

Click or tap the input field of **DataBits**, and then use the pop-up numeric keypad to set the number of bits in the serial data string. You can also use the corresponding multifunction knob to set the value. The number of bits in the string can be set to any integer ranging from 4 to 32.

### Level Selection and Setting

After the trigger condition setting is completed, you need to adjust the trigger level to properly trigger the signal and obtain a stable waveform.

- **Level A**

Click or tap the input field of **Level A** to input the level of CLK with the pop-up numeric keypad. You can also use the corresponding multifunction knob or the trigger level knob to adjust the level of CLK. When the level A information is displayed in the trigger label, you can also use the trigger level knob to adjust the level of CLK. For details, refer to descriptions in *Trigger Level*. The current trigger level is displayed in the trigger information label at the top of the screen.

- **Level B**

Click or tap the input field of **Level B** to input the level of MISO with the pop-up numeric keypad. You can also use the corresponding multifunction knob to adjust the level of MISO. When the level B information is displayed in the trigger label, you can also use the trigger level knob to adjust the level of MISO. For details, refer to descriptions in *Trigger Level*. The current trigger level is displayed in the trigger information label at the top of the screen.

- **Level C**

Click or tap the input field of **Level C** to input the level of CS with the pop-up numeric keypad. You can also use the corresponding multifunction knob to adjust the level of CS. When the level C information is displayed in the trigger label, you can also use the trigger level knob to adjust the level of CS. For details, refer to descriptions in *Trigger Level*. The current trigger level is displayed in the trigger information label at the top of the screen.

## 8.7.16 CAN Trigger

This series oscilloscope can trigger on the start of a frame, end of a frame, frame of the specified type (e.g. Remote, Overload, Data, etc.), or error frame of the specified type (e.g. Answer Error, Check Error, Format Error, etc.) of the CAN signal.

The data frame format of the CAN bus is as shown in the figure below.

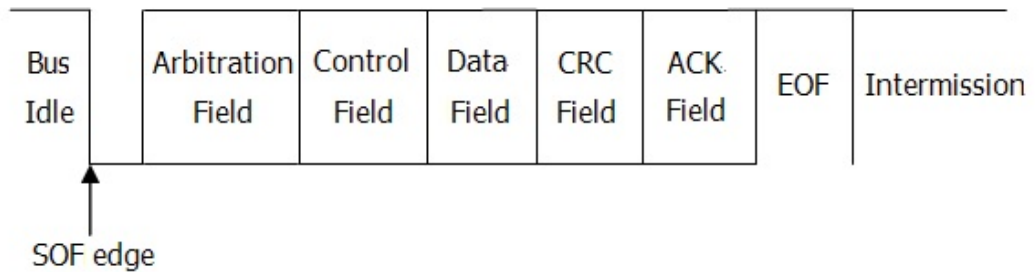

**Figure 8.32 Data Frame Format of the CAN Bus**

### Trigger Type

Click or tap the drop-down button of **Type** to select "CAN".

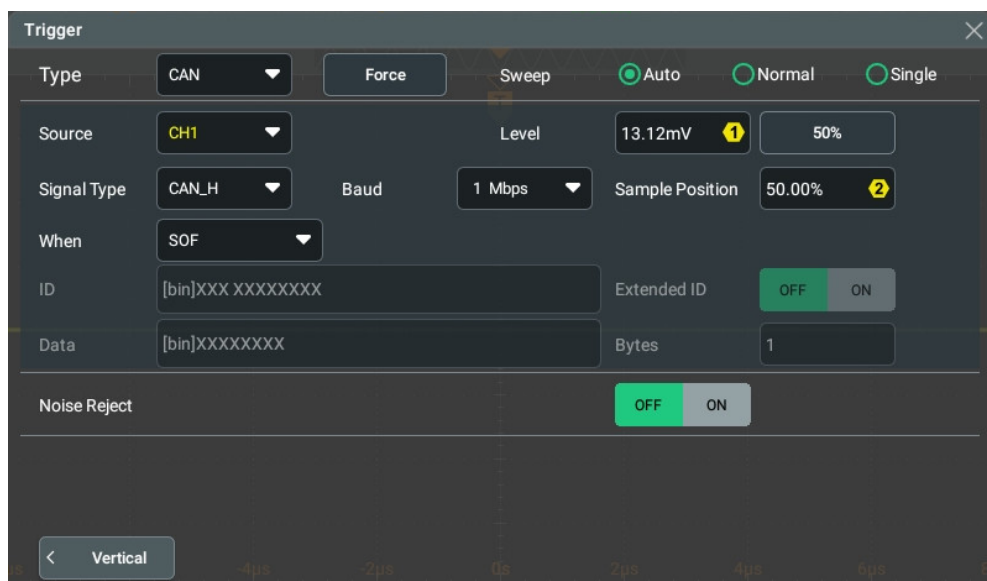

**Figure 8.33 CAN Trigger Setting Menu**

After a trigger type is selected, the current trigger setting information (including trigger type, trigger source, and trigger level) is displayed in the trigger information label at the top of the screen, as shown in the figure below. The information will change based on the trigger settings.

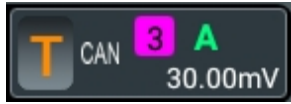

### Source Selection

Click or tap the drop-down button of **Source** to select CH1-CH4 or D0-D15. For details, refer to descriptions in *Trigger Source*. The selected trigger source is indicated in the trigger information label at the top of the screen.

Only when you select the channel that has been input with signals as the trigger source, can you obtain a stable trigger.

### Signal Type

Click or tap the drop-down button of **Signal Type** to select the desired signal type.

- CAN\_H: indicates the actual CAN\_H bus signal.
- CAN\_L: indicates the actual CAN\_L bus signal.
- TX/RX: indicates the Transmit signal and Receive signal from the CAN bus transceiver.
- DIFF: indicates the CAN differential bus signals connected to an analog channel by using a differential probe. Connect the probe's positive lead to the CAN\_H bus signal and connect the negative lead to the CAN\_L bus signal.

### Baud Rate

Click or tap the drop-down button of **Baud** to select the preset baud rate. The available baud rates include 10 kbps, 20 kbps, 33.3 kbps, 50 kbps, 62.5 kbps, 83.3 kbps, and etc. You can also self-define the baud rate.

### Sample Position

Sample position is a point within a bit's time. The oscilloscope samples the bit level at this point. The sample position is represented by the proportion of "the time from the start of the bit to the sample position" to the "bit time", as shown in the figure below.

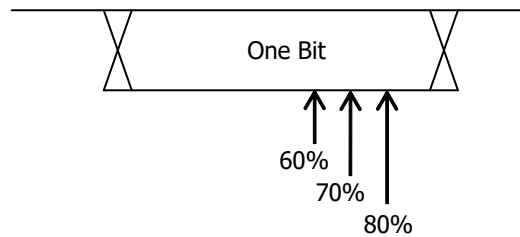

**Figure 8.34 Sample Position**

Click or tap the input field of **Sample Position** to set it by using the pop-up numeric keypad. You can also use the corresponding multifunction knob to set the value. The settable range is from 10% to 90%.

### Trigger Condition

Click or tap the drop-down button of **When** to select the desired trigger condition.

- SOF: triggers at the start of a frame.
- EOF: triggers at the end of a frame.
- Remote ID: triggers on the specified ID of Remote frame. When you select **Remote ID**, you need to set the following parameters.
  - Click or tap the ON/OFF tab for **Extended ID** to enable or disable the extended ID.
  - Click or tap the input field of **ID**, and then the "Format" interface is displayed. You can set the ID that needs to be operated on. For details, refer to descriptions in *I2C Trigger*.
- Overload: triggers on the overload frames.
- Frame ID: triggers on the data frames with the specified ID. After you select **Frame ID**, you can refer to the "Remote ID" mentioned above to set the **Extended ID** and **ID**.
- Frame Data: triggers on the data frames with the specified Data. When you select **Frame Data**, you need to set the following parameters.
  - Click or tap the input field of **Data**, and then the "Format" interface is displayed. You can set the data bit that needs to be operated on. For details, refer to descriptions in *I2C Trigger*.
  - Click or tap the input field of **Bytes**, and then use the pop-up numeric keypad to set the length of the data. You can also use the corresponding multifunction knob to set the value. Its range is from 1 to 8.
- Data & ID: triggers on the data frames with the specified ID and data. When you select **Data&ID**, you need to set the **ID**, **Extended ID**, **Data**, and **Bytes**.
- Frame Error: triggers on the error frame.

- Bit Fill: triggers on the error frame with the bit fill.
- Answer Error: triggers on the answer error frame.
- Check Error: triggers on the check error frame.
- Format Error: triggers on the format error frame.
- Random Error: triggers on the random error frame, such as the format error frame, answer error frame, etc.

### 8.7.17 LIN Trigger

This series can trigger on the sync field of LIN signal, and can also trigger on the specified identifier, data, or frame.

The data frame format of the LIN bus is as shown in the figure below.

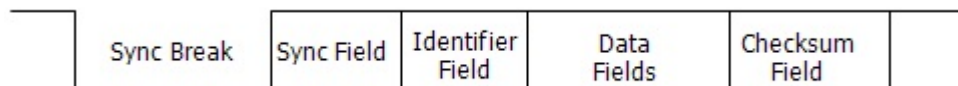

Figure 8.35 Data Frame Format of the LIN Bus

#### Trigger Type

Click or tap the drop-down button of **Type** to select "LIN".

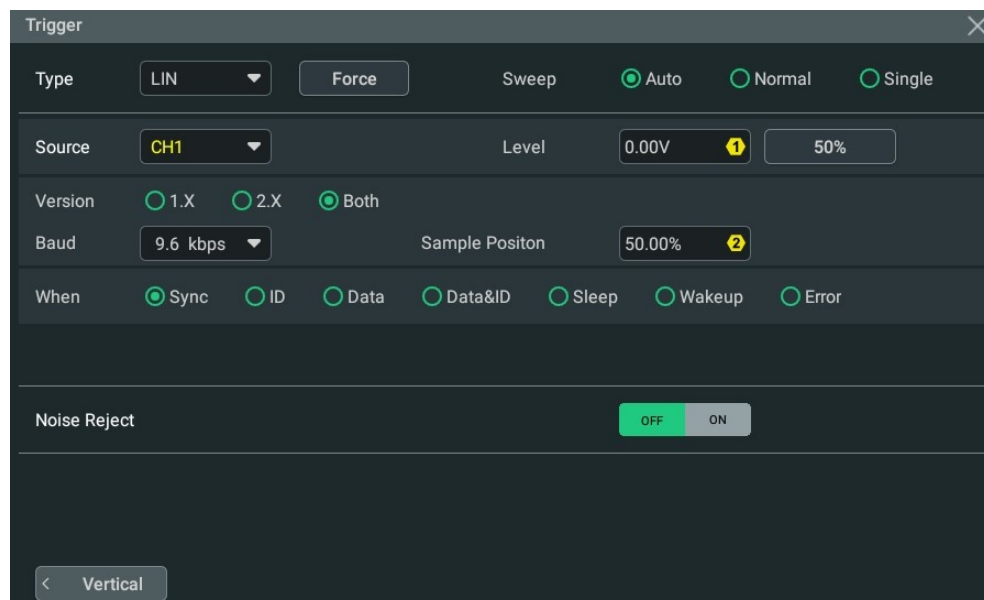
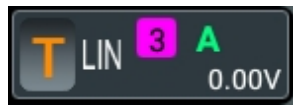

Figure 8.36 LIN Trigger Setting Menu

After a trigger type is selected, the current trigger setting information (including the trigger type, source, and level) is displayed in the trigger information label at the top

of the screen, as shown in the figure below. The information will change based on the trigger settings.



### Source Selection

Click or tap the drop-down button of **Source** to select CH1-CH4 or D0-D15. For details, refer to descriptions in *Trigger Source*. The selected trigger source is indicated in the trigger information label at the top of the screen.

Only when you select the channel that has been input with signals as the trigger source, can you obtain a stable trigger.

### Protocol Version

In **Version**, select the protocol version that matches the signal under test. The available versions include 1.X, 2.X, and Both.

### Baud Rate

Click or tap the drop-down button of **Baud** to select the preset baud rate. The available baud rates include 1.2 kbps, 2.4 kbps, 4.8 kbps, 9.6 kbps, 19.2 kbps, and etc. You can also self-define the baud rate.

### Sample Position

Sample position is a point within a bit's time. The oscilloscope samples the bit level at this point. The sample position is represented by the proportion of "the time from the start of the bit to the sample position" to the "bit time", as shown in the figure below.

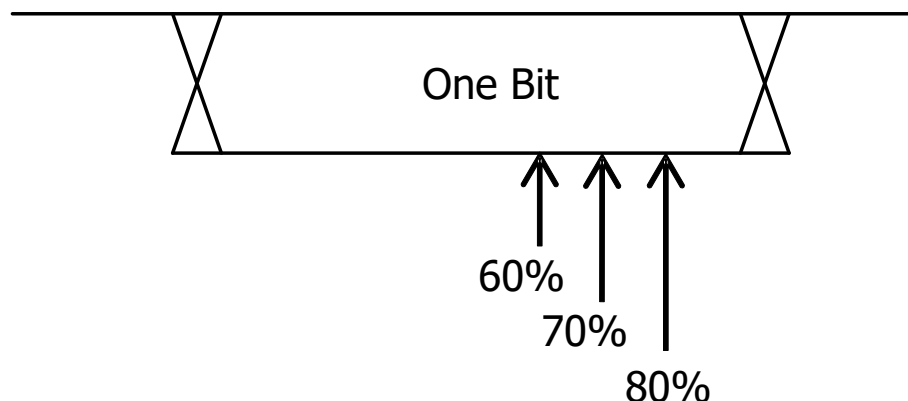

**Figure 8.37 Sample Position**

Click or tap the **Sample Position** input field and use the pop-up numeric keypad to set the value. You can also use the corresponding multifunction knob to set the value. The settable range is from 10% to 90%.

### Trigger Condition

Click or tap the drop-down button of **When** to select the desired trigger condition.

- **Sync:** triggers on the last bit of the sync field.
- **ID:** triggers when the frames with the specified ID are found.

Click or tap the input field of **ID**, and then use the pop-up numeric keypad to set ID. You can also use the corresponding multifunction knob to set the value.

- **Data:** triggers when the data that meet the preset conditions are found.
  - Click or tap the input field of **Data**, and then the "Format" interface is displayed. You can set the data bit that needs to be operated on. For details, refer to descriptions in *I2C Trigger*.
  - Click or tap the input field of **Bytes**, and then use the pop-up numeric keypad to set the length of the data. You can also use the corresponding multifunction knob to set the value. Its range is from 1 to 8.
- **Data&ID:** triggers when the frames with the specified ID and data that meet the preset conditions are both found.

When **Data&ID** is selected, you need to set the **Data**, **Bytes**, and **ID**.

- **Sleep:** triggers when the sleep frame is found.
- **Wakeup:** triggers when the wakeup frame is found.
- **Error:** triggers on the specified type of error frame. Click or tap the drop-down button of **Error Type** to select the error type: Sync, Even Odd, or Check Sum.

## 8.7.18 FlexRay Trigger (Option)

The oscilloscope can trigger on the specified frame, symbol, error, or position of the FlexRay bus. FlexRay is a type of differential serial bus configured with three consecutive segments (i.e. packet header, payload, and packet trailer). Its data transmission rate is up to 10 Mb/s. Each frame contains a static segment and a dynamic segment, with each frame ending with the bus idle time.

Its format is as shown in the figure below.

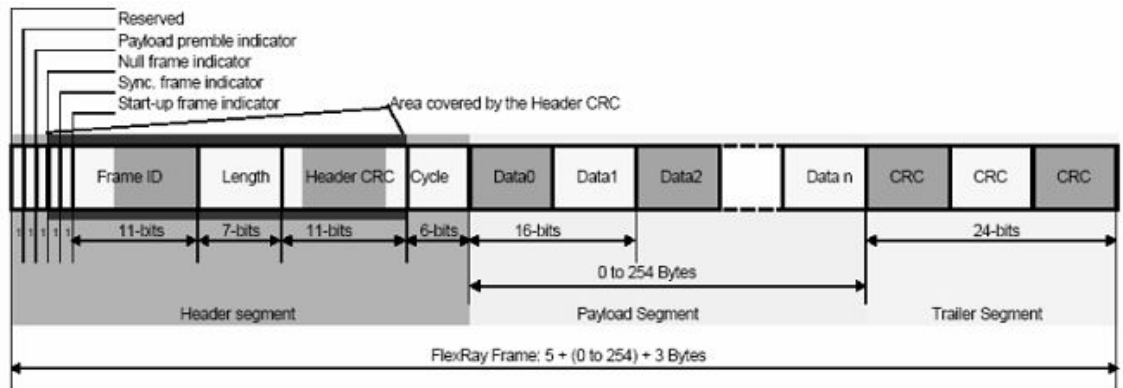

Figure 8.38 Frame Format of the FlexRay Bus

### Trigger Type

Click or tap the drop-down button of **Type** to select "FlexRay" from the drop-down list. Then set the parameters for FlexRay trigger.

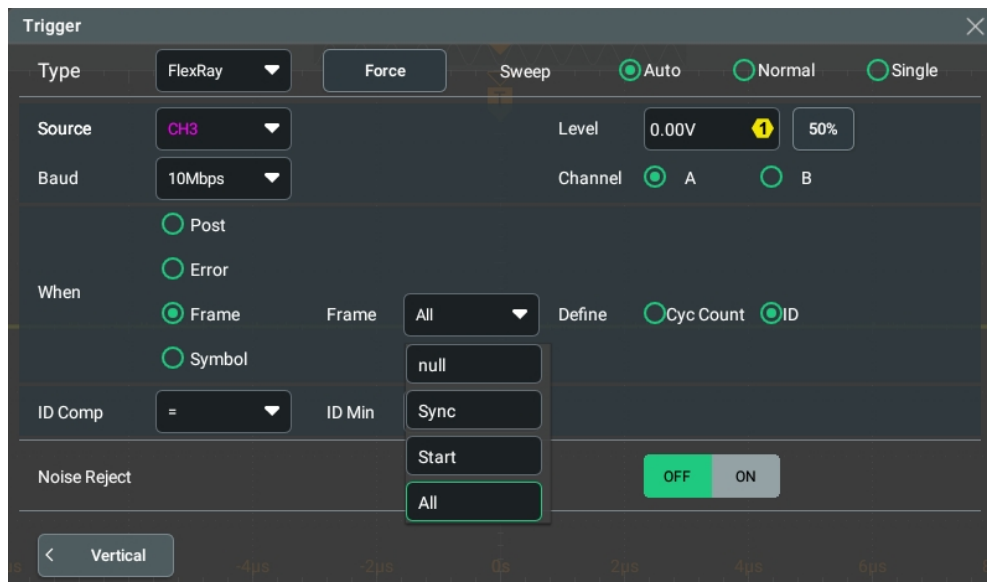
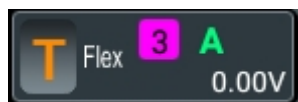

Figure 8.39 FlexRay Trigger Setting Menu

After selecting the trigger type, and then the current trigger setting information (including trigger type, trigger source, and trigger level) is displayed in the trigger information label at the top of the screen, as shown in the figure below. The information will change based on the trigger settings.



## Source Selection

Click or tap the drop-down button of **Source** to select CH1-CH4 or D0-D15. For available channels, refer to descriptions in *Trigger Source*. The selected trigger source is indicated in the trigger information label at the top of the screen.

Only when you select the channel that has been input with signals as the trigger source, can you obtain a stable trigger.

## Baud Rate

Set the Baud Rate. Click and tap the drop-down button of **Baud** to select the variable baud rate from the drop-down list. The available baud rates include 2.5 Mbps, 5 Mbps and 10 Mbps.

## Trigger Condition

Select the trigger condition in the **When** menu.

- **Post**: triggers on the specified position of the FlexRay bus. Select **Post** as the trigger condition, and then click or tap its drop-down button to select "TSS End", "FSS\_BSS End", "FES End", or "DTS End" from the drop-down list.
- **Error**: triggers when an error occurs to the FlexRay bus. Click or tap the drop-down button of **Error** to select the error type. It includes Head CRC Err, Tail CRC Err, Decode Err, and Random Err.
- **Frame**: triggers on the frame of FlexRay bus.

- Click or tap the drop-down button of **Frame** to select the frame type. The types of frames include null, Syms, Start, and All.
- Select "Cyc Count" or "ID" under the **Define** menu.

When you select "Cyc Count", set the following parameters: Cyc Comp, Count Min, and Count Max. Click or tap the drop-down button of **Cyc Comp** to select the comparison conditions. The available choices include =, ≠, >, <, > <, and < >. When a certain condition is selected, click or tap the input field of **Count Min** or **Count Max**.

When you select "ID", set the following parameters: ID Comp, ID Min, and ID Max. Click or tap the drop-down button of **ID Comp** to select the comparison conditions. The available choices include =, ≠, >, <, > <, and < >. When a certain condition is selected, click or tap the input field of **ID Max** or **ID Min**.

- **Symbol**: triggers on the CAS/MTS (Collision Avoidance Symbol / Media Access Test Symbol) and the WUS (Wake-Up Symbol) of the FlexRay bus.
  - Click or tap the drop-down button of **Symbol** to select the symbol type of CAS/MTS and WUS.

- Click or tap the comparison conditions from the **ID Comp** menu. The available choices include =, ≠, >, <, > < and < >.

As the occurrence possibility of specified flexray frame is very low, it is recommended that you set the oscilloscope to Normal trigger mode when the trigger condition is set to "Frame", so as to prevent the instrument from triggering automatically while waiting for the specified frame. The same goes for "Error" trigger condition. And, when there are multiple FlexRay errors, you may need to adjust the trigger suppression to view specific errors.

### Trigger Mode

In **Sweep**, select Auto, Normal, or Single as the trigger mode. For details, refer to descriptions in *Sweep*.

### Trigger Parameter Setting

You can refer to *Noise Reject* to set the noise rejection under this trigger type.

### Trigger Level

Click or tap the **Level** input field to set the trigger level with the pop-up numeric keypad. You can also use the front-panel trigger level knob or the corresponding multifunction knob to set the trigger level. For details, refer to descriptions in *Trigger Level*. The current trigger level is displayed in the trigger information label at the top of the screen.

## 8.7.19 I2S Trigger (Option)

In I2S trigger, the oscilloscope searches for the specified data value and take it as the condition for identifying the trigger. You need to specify the serial clock line (SCLK, 1 pulse is found on the clock line once 1 bit of digital audio data is sent), frame clock line (WS, used for switch the audio channel data), and serial data line (SDA, used for transmit audio data represented in binary (2's complement)).

Below is the sequential chart of I2S bus.

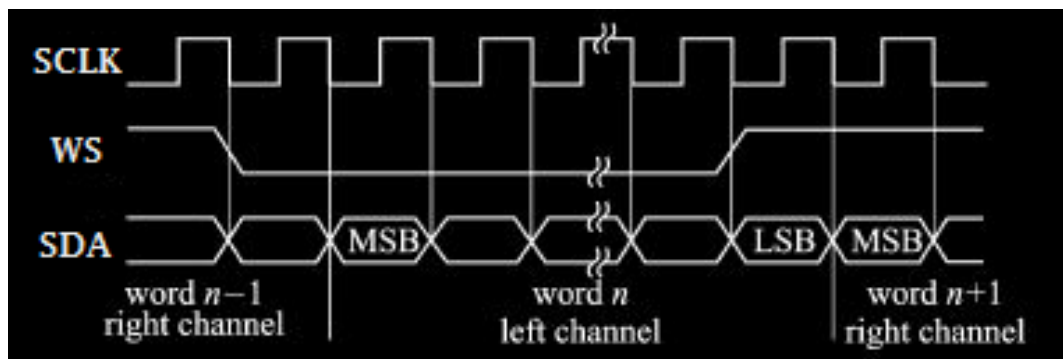

Figure 8.40 Sequential Chart of I2S Bus

## Trigger Type

Click or tap the drop-down button of **Type** to select "I2S".

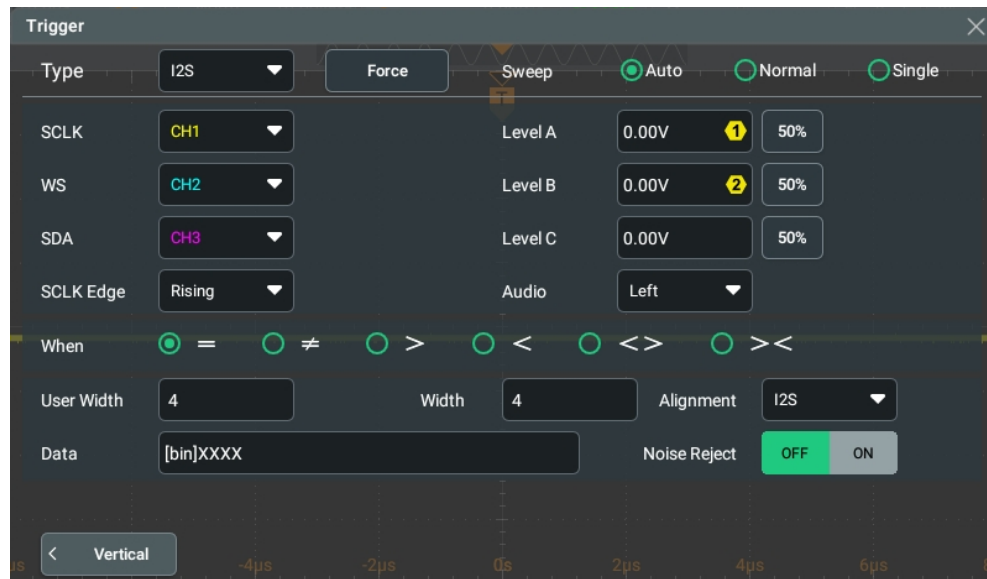
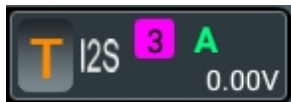

Figure 8.41 I2S Trigger Setting Menu

After a trigger type is selected, the current trigger setting information (including the trigger type, source, and level) is displayed in the trigger information label at the top of the screen, as shown in the figure below. The information will change based on the trigger settings.



## Source Selection

Click or tap the drop-down button of **SCLK**, **WS**, and **SDA** to select the source of serial clock (SCLK), word select (WS), and serial data (SDA) signal. For details, refer to descriptions in *Trigger Source*. The selected trigger source is indicated in the trigger information label at the top of the screen.

Only when you select the channel that has been input with signals as the trigger source, can you obtain a stable trigger.

## Edge Type

In **SCLK Edge** menu, click or tap to select the desired clock edge.

- Rising: samples the SDA data on the rising edge of the clock.
- Falling: samples the SDA data on the falling edge of the clock.

## Audio

Click or tap the drop-down button of **Audio** to select the audio channel ("Left", "Right", or "Either").

## Trigger Condition

Click or tap the drop-down button of **When** to select the desired trigger condition. For details, refer to descriptions in *I2C Trigger*.

- **=**: triggers when the channel's data equal the set data value. Click or tap the input field of **Data**, and the "Format" interface is displayed. You can set the data bit that needs to be operated on.
- **≠**: triggers when the channel's data do not equal the set data value. Click or tap the input field of **Data**, and the "Format" interface is displayed. You can set the data bit that needs to be operated on.
- **>**: triggers when the channel's data value is greater than the set data value. Click or tap the input field of **Data Min**, and then the "Format" interface is displayed. You can set the lower limit of the data value.
- **<**: triggers on when the channel's data value is smaller than the set data value. Click or tap the input field of **Data Max**, and then the "Format" interface is displayed. You can set the upper limit of the data bit value.
- **< >**: triggers when the channel's data value is smaller than the upper limit of the data value and greater than the lower limit of the data value. Click or tap the input field of **Data Max** and **Data Min**, and then the "Format" interface is displayed. You can set the upper limit and lower limit of the data value.
- **> <**: triggers when the channel's data value is greater than the upper limit of the data value or smaller than the lower limit of the data value. Click or tap the input field of **Data Max** and **Data Min**, and then the "Format" interface is displayed. You can set the upper limit and lower limit of the data value.

## User Width

Click or tap the input field of **User Width** and use the pop-up numeric keypad to set the length of the data. You can also use the corresponding multifunction knob to set the value. Its range is from 4 to 32.

The user width is smaller than or equal to the width.

## Width

Click or tap the input field of **Width** and use the pop-up numeric keypad to set the width. You can also use the corresponding multifunction knob to set the value. Its range is from 4 to 32.

## Alignment

Click or tap the drop-down button of **Alignment** to select the alignment way for data signal.

- **Standard I2S:** data transmission (MSB first) begins at the second edge of the WS transition.
- **LJ:** data transmission (MSB first) begins at the edge of the WS transition.
- **RJ:** data transmission (MSB first) is right-justified to the WS transition.

## Trigger Mode

In **Sweep**, select Auto, Normal, or Single as the trigger mode. For details, refer to descriptions in *Sweep*.

## Trigger Parameter Setting

You can refer to *Noise Reject* to set the noise rejection under this trigger type.

## Trigger Level

- **Level A**

Sets the trigger level of SCLK. Click or tap the input field of **Level A** to set the trigger level with the pop-up numeric keypad. You can also use the corresponding multifunction knob or the trigger level knob to adjust the specified trigger level. For details, refer to descriptions in *Trigger Level*. The current trigger level is displayed in the trigger information label at the top of the screen.

- **Level B**

Sets the trigger level of WS. Click or tap the input field of **Level B** to set the trigger level with the pop-up numeric keypad. You can also use the corresponding multifunction knob or the trigger level knob to adjust the specified trigger level. For details, refer to descriptions in *Trigger Level*. The current trigger level is displayed in the trigger information label at the top of the screen.

- **Level C**

Sets the trigger level of SDA. Click or tap the input field of **Level C** to set the trigger level with the pop-up numeric keypad. You can also use the corresponding multifunction knob or the trigger level knob to adjust the specified trigger level. For details, refer to descriptions in *Trigger Level*. The current trigger level is displayed in the trigger information label at the top of the screen.

## 8.7.20 MIL-STD-1553 Trigger (Option)

1553B is the abbreviation for the MIL-STD-1553 bus. This series can trigger on the sync field of 1553B bus, and can also trigger on the specified data word, command word, status word, or error type.

The command word, data word, and status word format of the 1553B bus is as shown in the figure below.

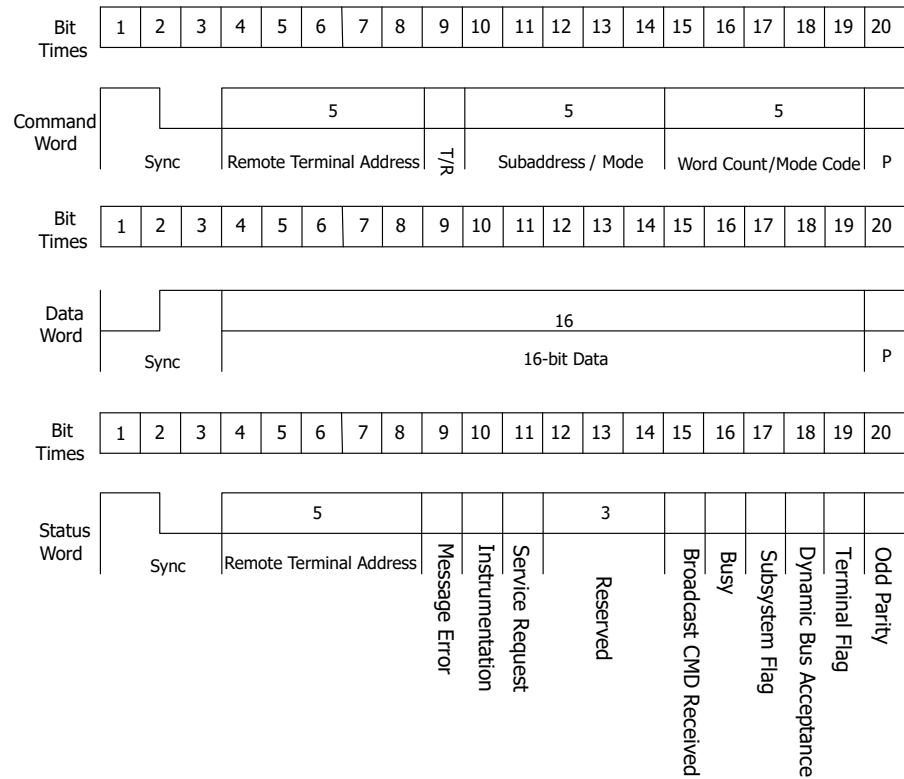

**Figure 8.42 Formats of the Command Word, Data Word, and Status Word of the 1553B Bus**

### Trigger Type

Click or tap the drop-down button of **Type** to select "1553B" from the drop-down list. Then set the parameters for MIL-STD-1553 trigger.

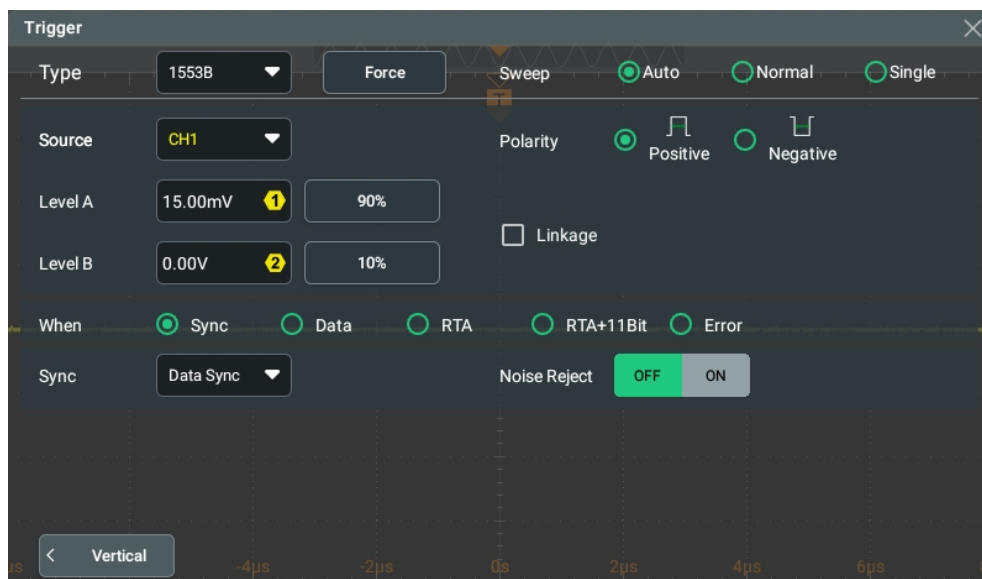
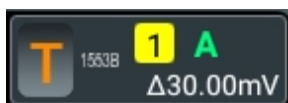

Figure 8.43 MIL-STD-1553 Trigger Setting Menu

After a trigger type is selected, the current trigger setting information (including trigger type, trigger source, and trigger level) is displayed in the trigger information label at the top of the screen, as shown in the figure below. The information will change based on the trigger settings.





### Select the Source

Click or tap the drop-down button of **Source** to select analog channel or digital channel as the trigger source. For available channels, refer to descriptions in *Trigger Source*. The selected trigger source is indicated in the trigger information label at the top of the screen.

Only when you select the channel that has been input with signals as the trigger source, can you obtain a stable trigger.

### Polarity

In the **Polarity** item, select the desired polarity: positive polarity (  ) or negative polarity (  ).

### Level Selection and Setting

After the trigger condition setting is completed, you need to adjust the trigger level to correctly trigger the signal and obtain a stable waveform.

Click or tap the **Level A/Level B** input field to set the level A/level B with the pop-up numeric keypad. You can also use the trigger level knob or use the specified multifunction knob to adjust level A/level B. Check the checkbox of **Linkage** to link Level A and Level B. The Level A and Level B will be adjusted synchronously. The upper limit and lower limit values change at the same time. The difference between upper and lower limit remains unchanged. For details, refer to descriptions in *Trigger Level*. The current trigger level is displayed in the trigger information label at the top of the screen.

#### TIP

Press down the trigger level knob and rotate it to adjust Level A, Level B, and Level AB (when linkage is enabled) in sequence.

#### Trigger Condition

Click or tap the drop-down button of **When** to select the desired trigger condition.

- **Sync:** triggers on the specified sync type. After this trigger condition is selected, click or tap the drop-down button of **Sync** to select the desired sync type: Data Sync, C/S Sync, or All Sync.
- **Data:** triggers on the specified data word. After this trigger condition is selected, click or tap the comparison conditions from the **Comp** menu. The available choices include =, ≠, >, <, < >, and > <.
  - =: triggers when the channel's data word equals the set data word. Click or tap the input field of **Min**, and then the "Format" interface is displayed. You can set the lower limit of the data word. For details, refer to descriptions in *I2C Trigger*.
  - ≠: triggers when the channel's data word does not equal the set data word. Click or tap the input field of **Min**, and then the "Format" interface is displayed. You can set the lower limit of the data word. For details, refer to descriptions in *I2C Trigger*.
  - >: triggers when the channel's data word is greater than the set data word. Click or tap the input field of **Min**, and then the "Format" interface is displayed. You can set the lower limit of the data word. For details, refer to descriptions in *I2C Trigger*.
  - <: triggers when the channel's data word is smaller than the set data word. Click or tap the input field of **Max**, and then the "Format" interface is displayed. You can set the upper limit of the data word. For details, refer to descriptions in *I2C Trigger*.
  - < >: triggers when the channel's data word is smaller than the upper limit of the data word and greater than the lower limit of the data word. Click or tap the input field of **Max** and **Min**, and then the "Format" interface is displayed. You can set the upper limit and lower limit of the data word. For details, refer to descriptions in *I2C Trigger*.

- > <: triggers when the channel's data word is greater than the upper limit of the data word or smaller than the trigger lower limit of the data word. Click or tap the input field of **Max** and **Min**, and then the "Format" interface is displayed. You can set the upper limit and lower limit of the data word. For details, refer to descriptions in *I2C Trigger*.
- **RTA**: triggers on the specified remote terminal address. After this trigger condition is selected, click or tap the input field of **RTA**, then the "Format" interface is displayed. You can set the remote terminal address. For details, refer to descriptions in *I2C Trigger*.
- **RTA+11Bit**: triggers on the RTA and the remaining 11 bits.  
After this trigger condition is selected:
  - Click or tap the input field of **RTA**, and then the "Format" interface is displayed. You can set the remote terminal address. For details, refer to descriptions in *I2C Trigger*.
  - Click or tap the input field of **Bit time**, and then the "Format" interface is displayed. You can set the bit time position value to 0 (low), 1 (high), or X (unrelated). For details, refer to descriptions in *I2C Trigger*.
- **Error**: triggers on the specified error type. After this trigger condition is selected, click or tap the drop-down button of **Err Type** to select the error type.
  - **Sync Error**: triggers when an invalid sync pulse is found.
  - **Check Error**: triggers when the parity bit is incorrect for the data in the word.

## 8.8 Trigger Output Connector



The rear-panel trigger output connector (**[AUX OUT]**) of this series can output trigger signals determined by the current setting (hardware trigger).

Click or tap  > **Utility**. Click or tap **Setup**, and then select "TrigOut" in **Aux Out**. A signal which reflects the current oscilloscope capture rate can be output from **[AUX OUT]** connector each time a trigger is generated by the oscilloscope. If this signal is connected to a waveform display device to measure the frequency, the measurement result is the same as the current capture rate.

If "PassFail" is selected in **Aux Out**, the instrument can output a pulse from the **[AUX OUT]** connector when a pass/failed event is detected during the pass/fail test.

## 9 Math Operation

This oscilloscope can realize multiple math operations between waveforms of different channels, including arithmetic operation, spectrum operation, logic operation, function operation, and digital filter. To enter the **Math** menu, perform any of the following operations:

- Click or tap the function navigation icon  at the lower-left corner of the screen, and then select **Math** to enter the "Math" menu.
- Click or tap **Math** on the toolbar at the upper-right of the interface to enter the "Math" menu.
- Click or tap **M1-M4** in the Math label at the bottom of the screen to open the "Math" window. You can also click or tap the Math label and then select a label from **M1-M4** to enter the corresponding Math window. Then click or tap the **M1-M4** label again, or the  icon at the upper-right corner of the window to enter the "Math" menu. The Math label is as shown in the figure below.



- Press the front-panel  key to enter the "Math" menu.

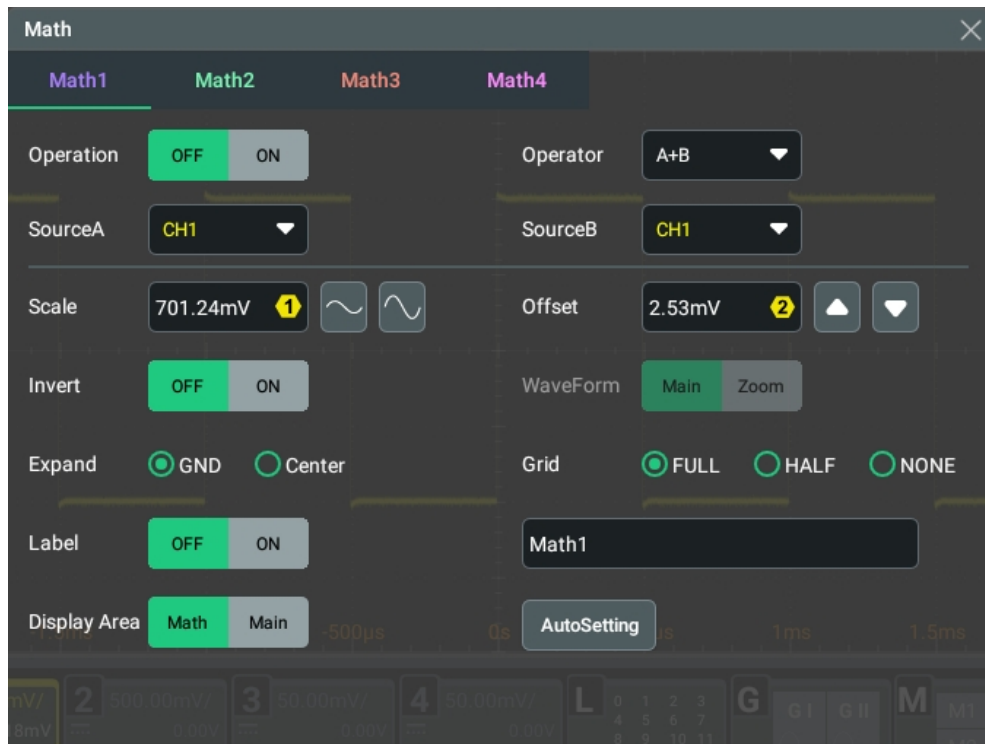



Figure 9.1 Math Menu

This oscilloscope provides four math operations: Math1, Math2, Math3, and Math4. In the **Math** menu, you can select the desired math operation type by clicking or tapping the **Math1-Math4** label or by sliding the menu left and right. This manual takes Math1 as an example to introduce math operation.

In the **Math** menu, click or tap the **Operation** on/off switch to show or hide the waveform display window of the operation results. By default, it is OFF. When "ON" is selected for Math1-Math4, the menu as shown in the figure below is displayed on the screen.



Figure 9.2 Waveform Display Window of the Operation Results

You can drag the title bar of the display window to change the position of the window. You can also click or tap  at the upper-right corner of the window to close it.

In the **Math** menu, click or tap the **Operation** on/off switch to enable the operation function. Click or tap **Display Area** to set the position of the waveform display window of the math operation results. By default, the display area is set to "Math". In this mode, the waveform of the math operation results is displayed in the Math window. When **Display Area** is set to "Main", both the waveform of the math operation results and the waveform of source channel are displayed in the main waveform view.

## 9.1 Arithmetic Operation

In the **Math** menu, click or tap the **Operator** drop-down button to select the desired math operation. The arithmetic operations supported by this oscilloscope include  $A+B$ ,  $A-B$ ,  $A \times B$ , and  $A \div B$ .

- **$A+B$**  adds the waveform voltage values of signal source A and B point by point and displays the results.
- **$A-B$**  subtracts the waveform voltage values of signal source B from that of source A point by point and displays the results.
- **$A \times B$**  multiplies the waveform voltage values of signal source A and B point by point and displays the results.
- **$A \div B$**  divides the waveform voltage values of signal source A by that of source B point by point and displays the results. It can be used to analyze the Multiple relation of the two channels waveforms.



### TIP

When the voltage of signal source B is 0 V, the division result is treated as 0.

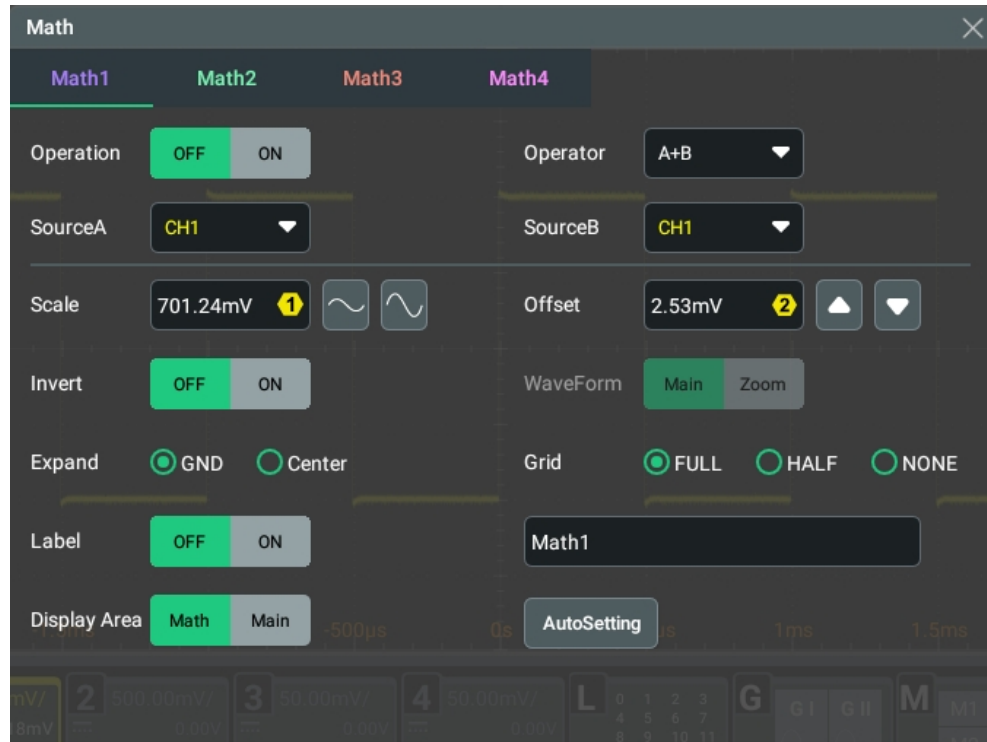

Figure 9.3 Arithmetic Operation Menu

#### Operation Result Display Window

Click or tap the **Operation** on/off switch to enable the display of the arithmetic operation result window. The source and the vertical scale parameters are displayed at the top of the window, as shown in the figure below.

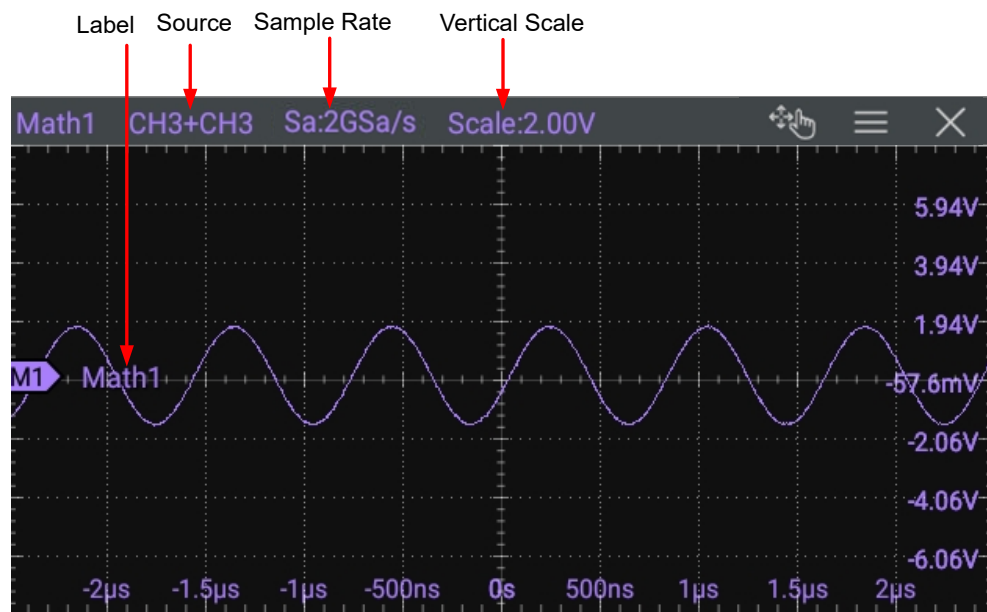

Figure 9.4 Operation Result Display Window

### Source

Click or tap the drop-down button of **SourceA** or **SourceB** to select CH1-CH4 or Ref1-Ref10. When a source channel is selected, the selected channel automatically switches to the ON state.



### TIP

Besides CH1-CH4 and Ref1-Ref10, the Math2 source can be set to Math1; the Math3 source can be set to Math1 or Math2; the Math4 source can be set to Math1, Math2, or Math3. Selecting a Math automatically enables its window display and sets its Operation on/off switch to ON.

### Scale

Scale is used to set the vertical scale of the operation result. You can set the vertical scale in the following ways.

- In the **Math** menu, rotate the corresponding multifunction knob on the front panel or click or tap the icon at the right side of the input field of **Scale** to increase or decrease the scale value. You can also click or tap the input field to input a specific value with the displayed numeric keypad.
- Close the menu and then adjust the vertical scale with the pinch&stretch gesture on the touch screen. You can also rotate the multifunction knob 1 on the front panel to adjust the vertical scale. Please refer to *Front Panel* to configure the front-panel multifunction knobs.

### Offset

Offset is used to set the vertical offset of the operation result. You can set the vertical offset in the following ways.

- In **Math** menu, rotate the corresponding multifunction knob on the front panel or click or tap the icon at the right side of the input field of **Offset** to increase or decrease the offset value. You can also click or tap the input field to input a specific value with the displayed numeric keypad.
- Close the menu and then adjust the vertical offset with the drag gesture on the touch screen. You can also rotate the multifunction knob 2 on the front panel to adjust the vertical offset. Please refer to *Front Panel* to configure the front-panel multifunction knobs.

### Invert

Invert is used to enable or disable the inverted display of the waveform. When the Invert function is disabled, the waveform is displayed normally; when enabled, the voltage values of the displayed waveform are inverted.

### Waveform

This oscilloscope provides Main and Zoom for the measurement range.

- **Main** indicates that the measurement range is within the main time base region.
- **Zoom** indicates that the measurement range is within the zoomed time base region.

To use "Zoom", first enable the *Zoom Mode (Delayed Sweep)* in the *Horizontal System* menu.

### Expand

The oscilloscope supports two vertical expansion modes: GND (default) and Center.

- **GND:** When the vertical scale is changed, the math operation waveform will expand or compress about the ground level of the signal.
- **Center:** When the vertical scale is changed, the math operation waveform will expand or compress about the center of the display.

### Auto Set

Click or tap **AutoSetting** to adjust the vertical scale and the offset of the operation results to the optimal value according to the current configuration for you to better observe.

### Label

It is used to set the label for the math operation results. For setting methods, refer to descriptions in *To Turn the Channel Label Display On/Off*.

### Grid

For setting methods, refer to the descriptions in *To Set the Screen Grid*.

## 9.2 Function Operation

In the **Math** menu, click or tap the **Operator** drop-down button to select the desired function operation. The available function operation types of this oscilloscope include Intg, Diff, Sqrt, Lg (Base 10 Logarithm), Ln, Exp, Abs, and AX+B.

- **Intg:** calculates the integral of the selected source. For example, you can use integral to measure the area under a waveform or the pulse energy.
- **Diff:** calculates the discrete time derivative of the selected source. For example, you can use differentiate to measure the instantaneous slope of a waveform.
- **Sqrt:** calculates the square roots of the selected source point by point and displays the results.
- **Lg (Base 10 Logarithm):** calculates the base 10 Logarithm of the selected source point by point and displays the results.

- **Ln:** calculates the natural logarithm (Ln) of the selected source point by point and displays the results.
- **Exp:** calculates the exponential of the selected source point by point and displays the results.
- **Abs:** calculates the absolute value of the selected source and displays the results.
- **AX+B:** applies a linear function to the selected source, and displays the results.

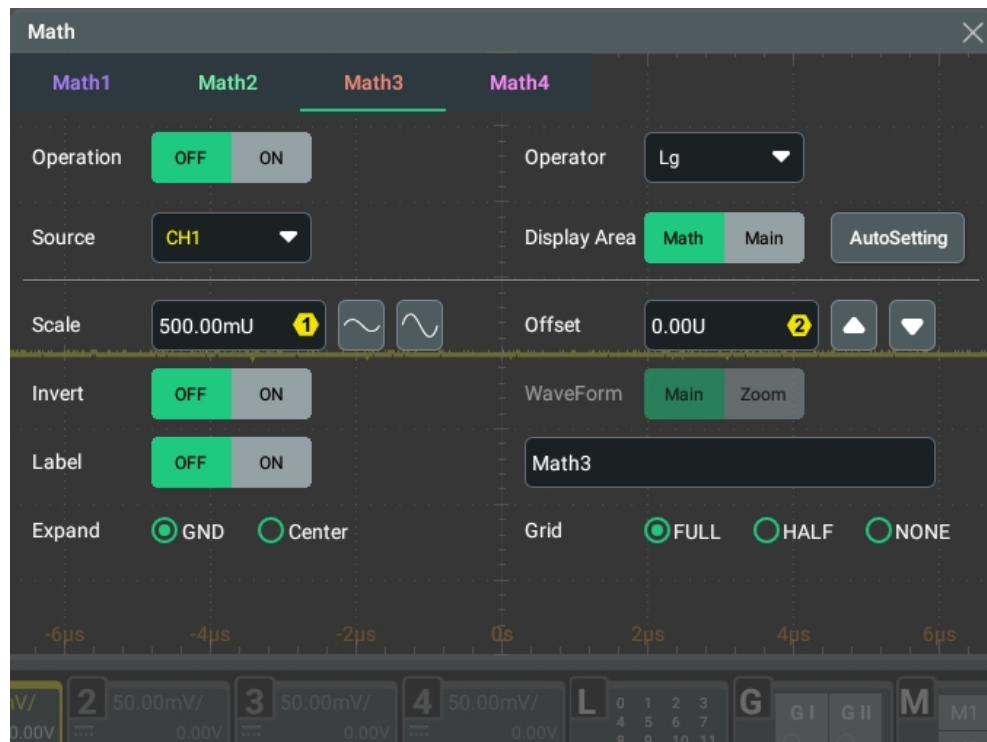

Figure 9.5 Function Operation Menu

### Operation Result Display Window

Click or tap the **Operation** on/off switch to enable the display of the operation result window. The source and the vertical scale parameters are displayed at the top of the window as shown in the figure below.

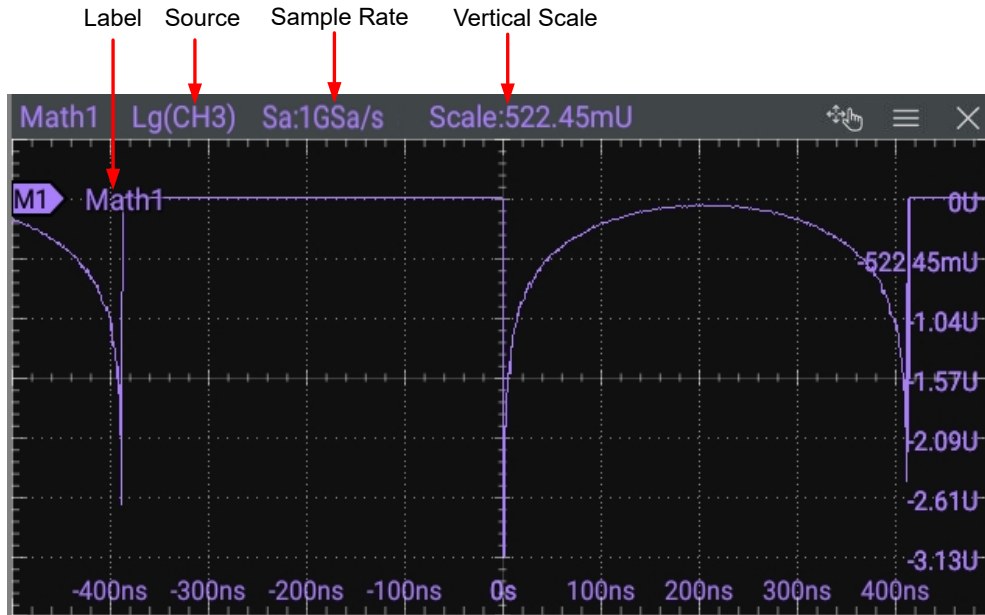

Figure 9.6 Operation Result Display Window

### Source

Click or tap the **Source** drop-down button to select the source from CH1-CH4 or Ref1-Ref10. When a source channel is selected, the selected channel automatically switches to the ON state.



### TIP

Besides CH1-CH4 and Ref1-Ref10, the Math2 source can be set to Math1; the Math3 source can be set to Math1 or Math2; the Math4 source can be set to Math1, Math2, or Math3. Selecting a Math automatically enables its window display and sets its Operation on/off switch to ON.

### Auto Set

Click or tap **AutoSetting** to adjust the vertical scale and the offset of the operation results to the optimal value according to the current configuration for you to better observe.

### Scale

Scale is used to set the vertical scale of the operation result. You can set the vertical scale in the following ways.

- In the **Math** menu, rotate the corresponding multifunction knob on the front panel or click or tap the icon at the right side of the input field of **Scale** to increase or decrease the scale value. You can also click or tap the input field to input a specific value with the displayed numeric keypad.
- Close the menu and then adjust the vertical scale with the pinch&stretch gesture on the touch screen. You can also rotate the multifunction knob 1 on the front

panel to adjust the vertical scale. Please refer to *Front Panel* to configure the front-panel multifunction knobs.

### Offset

Offset is used to set the vertical offset of the operation result. You can set the vertical offset in the following ways.

- In **Math** menu, rotate the corresponding multifunction knob on the front panel or click or tap the icon at the right side of the input field of **Offset** to increase or decrease the offset value. You can also click or tap the input field to input a specific value with the displayed numeric keypad.
- Close the menu and then adjust the vertical offset with the drag gesture on the touch screen. You can also rotate the multifunction knob 2 on the front panel to adjust the vertical offset. Please refer to *Front Panel* to configure the front-panel multifunction knobs.

### Invert

Invert is used to enable or disable the inverted display of the waveform. When the Invert function is disabled, the waveform is displayed normally; when enabled, the voltage values of the displayed waveform are inverted.

### Waveform

This oscilloscope provides Main and Zoom for the measurement range.

- **Main** indicates that the measurement range is within the main time base region.
- **Zoom** indicates that the measurement range is within the zoomed time base region.

To use "Zoom", first enable the *Zoom Mode (Delayed Sweep)* in the *Horizontal System* menu.

### Label

It is used to set the label for the math operation results. For setting methods, refer to descriptions in *To Turn the Channel Label Display On/Off*.

### Expand

The oscilloscope supports two vertical expansion modes: GND (default) and Center.

- **GND:** When the vertical scale is changed, the math operation waveform will expand or compress about the ground level of the signal.
- **Center:** When the vertical scale is changed, the math operation waveform will expand or compress about the center of the display.

## Grid

For setting methods, refer to the descriptions in *To Set the Screen Grid*.

### Parameter Setting

- When the operator is "Intg", click or tap the **Offset** input field and use the pop-up numeric keypad to set the DC offset calibration factor of the input signal. You can also use the corresponding multifunction knob to set the value.
- When the operator is "Diff", click or tap **Smooth** input field and use the pop-up numeric keypad to set the number of smooth times for the differential operation. You can also use the corresponding multifunction knob to set the value.
- When the operator is "AX+B", click or tap **A/B** input field and use the pop-up numeric keypad to set the A/B value. You can also use the corresponding multifunction knob to set the value.

## 9.3 FFT Operation

FFT (Fast Fourier Transform) is used to transform time-domain signals to frequency-domain components (frequency spectrum). This oscilloscope provides FFT operation function which enables you to observe the time-domain waveform and spectrum of the signal at the same time. FFT operation can facilitate the following works:

- Measure harmonic components and distortion in the system;
- Display the characteristics of the noise in DC power;
- Analyze the vibration.

In the **Math** menu, click or tap the **Operator** drop-down button to select **FFT** to access the menu as shown in *Figure 9.7*.

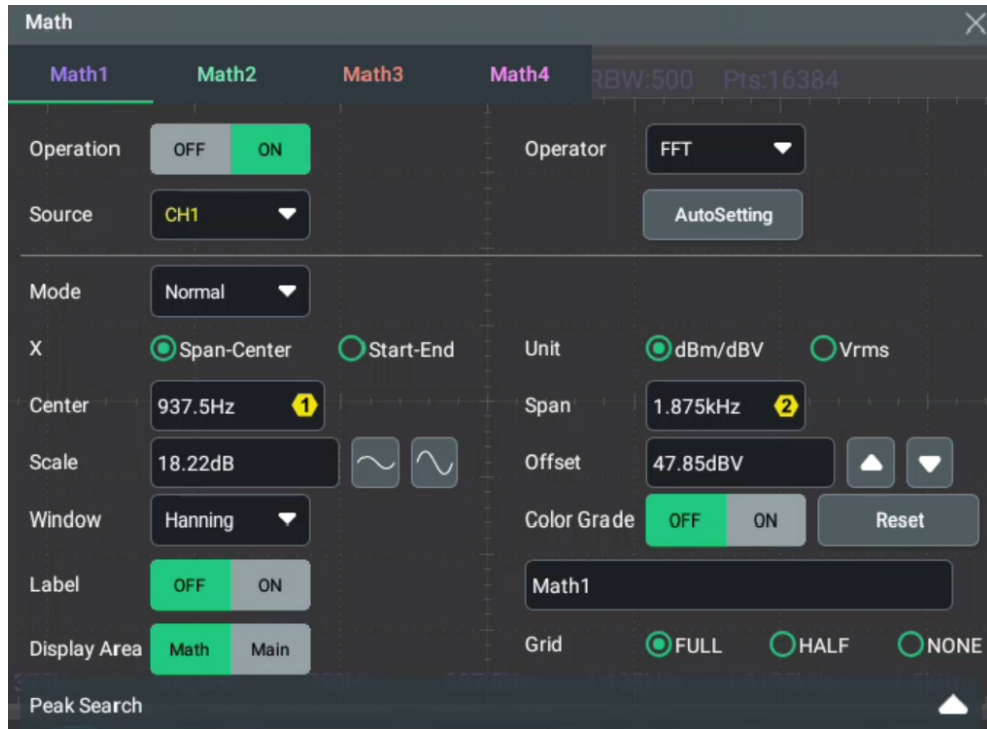

Figure 9.7 FFT Operation Menu

**Operation**

Click or tap the **Operation** on/off switch to enable the FFT operation result window. The parameters such as center frequency, frequency range, resolution and FFT points are displayed at the top of the window, as shown in the figure below. FFT resolution is the quotient of the sample rate and the number of FFT points. If the number of FFT points is a fixed value, then the higher the sample rate, the lower the resolution.

**NOTE**

The number of FFT analysis points can be 1 Mpts in maximum.

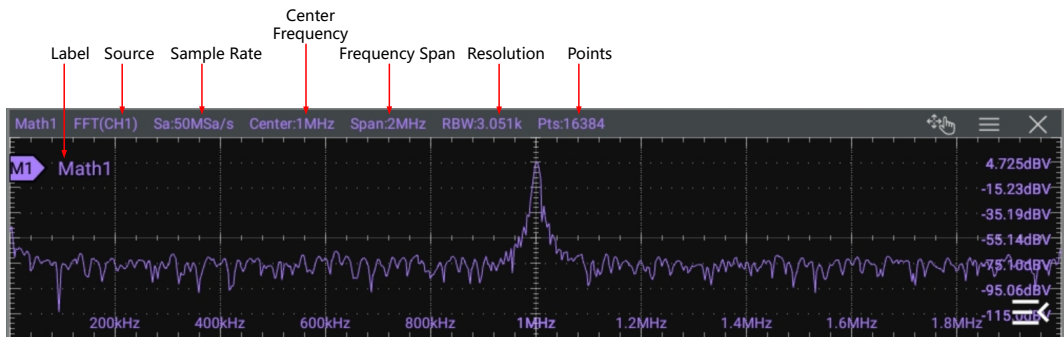

Figure 9.8 FFT Operation Window

### Source

Click or tap the **Source** drop-down button to select from CH1-CH4 or Math1-Math4. When a source channel is selected, the selected channel automatically switches to the ON state.

### NOTE

The Math2 source can be set to Math1; the Math3 source can be set to Math1 or Math2; the Math4 source can be set to Math1, Math2, or Math3. The data of currently selected source is used for FFT operation.

### Auto Set

Click or tap **AutoSetting** to adjust the vertical scale and the offset of the operation results to the optimal value according to the current configuration for you to better observe.

### Mode

Click or tap the **Mode** drop-down button to select Normal, Average, or Max Hold.

- Normal: shows each acquisition as new data is acquired. This is the default trace mode.
- Average: shows data that is moving-averaged over multiple FFT results. Average mode reduces noise and provides a more stable trace display. You can set the number of times of average. The minimum value is 2, the maximum value is 1000 and the default value is 10.
- Max hold: records and displays the maximum values that are occurred at each frequency point for capturing transient or intermittent signals.

### Frequency Range

In **X**, select "Span-Center" or "Start-End" mode and then configure the frequency range setting.

- **Span-Center (frequency span to center frequency):** Span specifies the frequency range represented by the width from the frequency at the left side of the window to the frequency at the right side of the window. Divide the frequency span by 10 to obtain the frequency per division.

Click or tap the **Center** input field to set the frequency of the frequency-domain waveform relative to the horizontal center of the screen. You can also use the corresponding multifunction knob to set the value. Its range is from 5 Hz to (2 GHz-5 Hz). By default, it is 1 MHz. Click or tap the **Span** input field to set the frequency span with the pop-up numeric keypad. You can also use the corresponding multifunction knob to set the value. Its range is from 10 Hz to 2 GHz. By default, it is 1 MHz.

- **Start-End (start frequency to stop frequency):** Start frequency specifies the frequency at the left side of the window. Click or tap the **Start** input field to set

the start frequency with the pop-up numeric keypad or use the corresponding multifunction knob to set the value. Its range is from 0 Hz to (stop frequency-10 Hz). By default, it is 1 Hz. Stop frequency specifies the frequency at the right side of the window. Click or tap the **End** input field to set the stop frequency with the pop-up numeric keypad or use the corresponding multifunction knob to set the value. Its range is from (start frequency +10 Hz) to 2 GHz. By default, it is 10 MHz.

### Vertical Scale/Offset

In **Unit** item, you can select **dBm/dBV** or **Vrms** as the unit for **Scale** and **Offset**.

For how to set the **Scale**, refer to the descriptions in *Scale* of "Arithmetic Operation".

For how to set the **Offset**, refer to the descriptions in *Offset* of "Arithmetic Operation".

### Window Function

Spectral leakage can be considerably minimized when a window function is used. The oscilloscope provides 6 FFT window functions which have different characteristics and are applicable to measure different waveforms, as shown in the table below. You need to select the window function according to the characteristics of the waveform to be measured. Click or tap the **Window** drop-down button to select the desired window function.

**Table 9.1 Window Function**

Window Function	Characteristics	Waveforms Applicable to the Window Function
Rectangular	Best frequency resolution Poorest amplitude resolution Similar to the situation when no window is applied	Transient or short pulse, the signal levels before and after the multiplication are basically the same Sine waveforms with the same amplitudes and rather similar frequencies Wide band random noise with relatively slow change of waveform spectrum
Blackman-Harris	Best amplitude resolution Poorest frequency resolution	Single frequency signal, searching for higher order harmonics
Hanning	Better frequency resolution and poorer amplitude resolution compared with Rectangular	Sine, periodic, and narrow band random noise

Window Function	Characteristics	Waveforms Applicable to the Window Function
Hamming	A little bit better frequency resolution than Hanning	Transient or short pulse, the signal levels before and after the multiplication are rather different
Flattop	Measure the signals accurately	Measure the signal that has no accurate reference and requires an accurate measurement
Triangle	Better frequency resolution	Measure the narrow band signal and that has strong noise interference

### Color Grade

Click or tap the **Color Grade** on/off switch to enable/disable the color grade display of FFT operation results. When it is enabled, different colors are displayed on the screen to indicate the times of data acquisition or acquisition probability. Click or tap the **Reset** button for the Color Grade menu to clear the color grade display and display the color grade again.

### Label

It is used to set the label for the math operation results. For setting methods, refer to descriptions in *To Turn the Channel Label Display On/Off*.

### Grid

For setting methods, refer to the descriptions in *To Set the Screen Grid*.

### Peak Search

Click or tap the icon  at the right side of **Peak Search** to enter the peak search menu, as shown in the figure below.

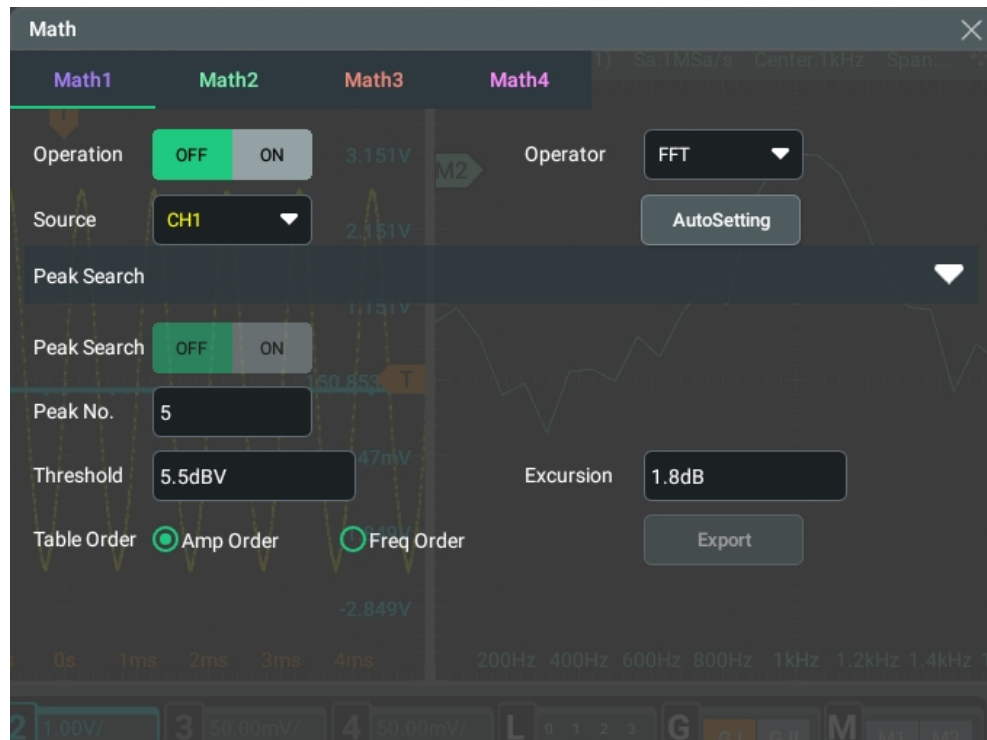

Figure 9.9 Peak Search

- **Peak Search ON/OFF:** click or tap the **Peak Search** on/off switch to enable or disable the display of the peak search window. By default, it is OFF.
- **Peak No.:** click or tap the input field for the **Peak No.** menu item and use the pop-up numeric keypad to set the number of peaks. You can also use the corresponding multifunction knob to set the value. Its range is from 1 to 15. Its default value is 5.
- **Threshold:** click or tap the input field for the **Threshold** menu item to set the threshold of the peak with the pop-up numeric keypad. You can also use the corresponding multifunction knob to set the value. The range of the threshold is related to the current FFT scale and offset.
- **Excursion:** click or tap the **Excursion** input field to set the excursion of the peak or use the corresponding multifunction knob to set the value. The minimum value of Excursion is 0 and its unit is consistent with that of FFT.
- **Table Order:** in **Table Order**, select **Amp Order** or **Freq Order** as the sorting mode. By default, it is "Amp Order".

Enable Peak Search and configure the number of Peak Number and Threshold. The operation window will dynamically mark the FFT peak points, and the peak search index will be displayed in the FFT chart, as shown in the figure below.

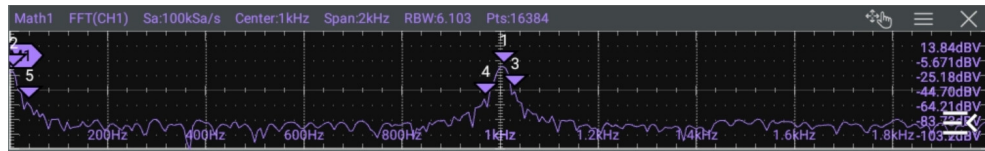



Figure 9.10 Peak Points Display Window

Click or tap **Export**, then the save setting interface is displayed. You can export the peak search results to the internal memory or the external USB storage device in CSV format. In the menu, click or tap **File Name** input field to set the file name; click or tap **File Path** input field and the disk management menu (*Disk Management*) is displayed. Select the desired location to save the file and then click or tap **Save** to save the peak search results.

Clicking or tapping the icon  at the right side of **Peak Search** can close the peak search menu.

## 9.4 Logic Operation

In the **Math** menu, click or tap the **Operator** drop-down button to select the desired math operation. The logic operations supported by this oscilloscope include A&&B, A||B, A^B, and !A. After selecting the desired logic operation in the drop-down button of **Operator**, you can configure its settings for the selected logic operation type.

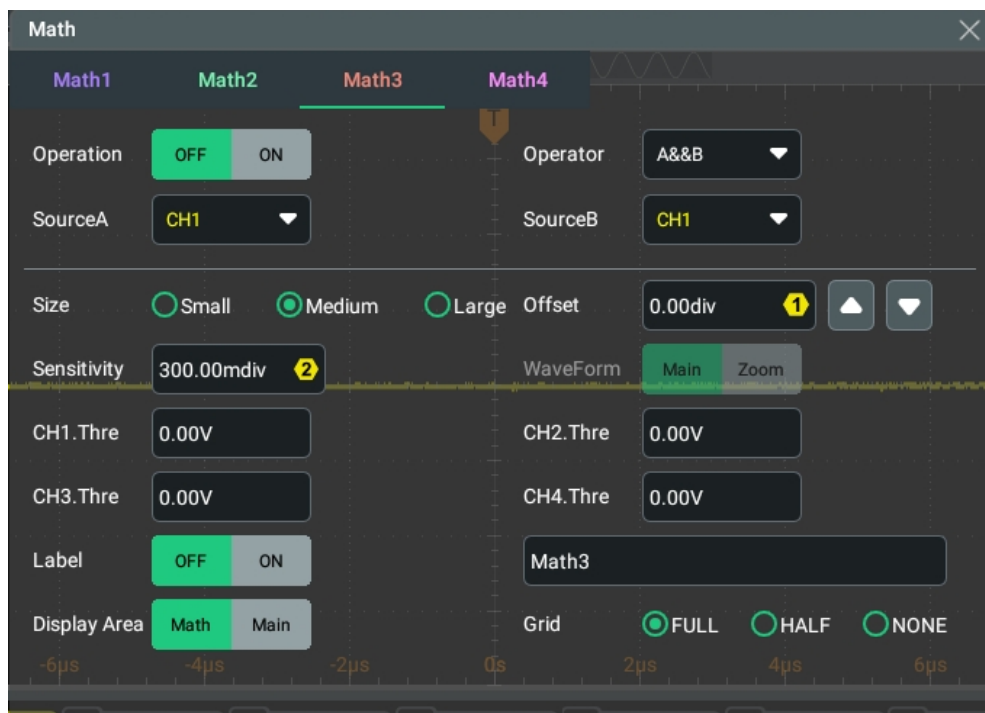

Figure 9.11 Logic Operation Menu

- **A&&B:** Performs logic "AND" operation on the waveform voltage values of the specified sources point by point and displays the results. In operation, when the voltage value of the source channel is greater than the threshold of the corresponding channel, it is regarded as logic "1"; otherwise it is logic "0". The results of logic AND operation of two binary bits are shown in *Table 9.2 Logic Operation*.
- **A||B:** Performs logic "OR" operation on the waveform voltage values of the specified sources point by point and displays the results. In operation, when the voltage value of the source channel is greater than the threshold of the corresponding channel, it is regarded as logic "1"; otherwise it is logic "0". The results of logic OR operation of two binary bits are shown in *Table 9.2 Logic Operation*.
- **A^B:** Performs logic "XOR" operation on the waveform voltage values of the specified sources point by point and displays the results. In operation, when the voltage value of the source channel is greater than the threshold of the corresponding channel, it is regarded as logic "1"; otherwise it is logic "0". The results of logic XOR operation of two binary bits are shown in *Table 9.2 Logic Operation*.
- **!A:** Performs logic "NOT" operation on the waveform voltage values of the specified sources point by point and displays the results. In operation, when the voltage value of the source channel is greater than the threshold of the corresponding channel, it is regarded as logic "1"; otherwise it is logic "0". The results of logic "NOT" operation of one binary bit are shown in *Table 9.2 Logic Operation*.

**Table 9.2 Logic Operation**

A	B	A&&B	A  B	A^B	!A
0	0	0	0	0	1
0	1	0	1	1	1
1	0	0	1	1	0
1	1	1	1	0	0

**Operation Result Display Window**

Click or tap the **Operation** on/off switch to enable the display of the operation result window. The source and the waveform sizes parameters are displayed at the top of the window, as shown in the figure below.

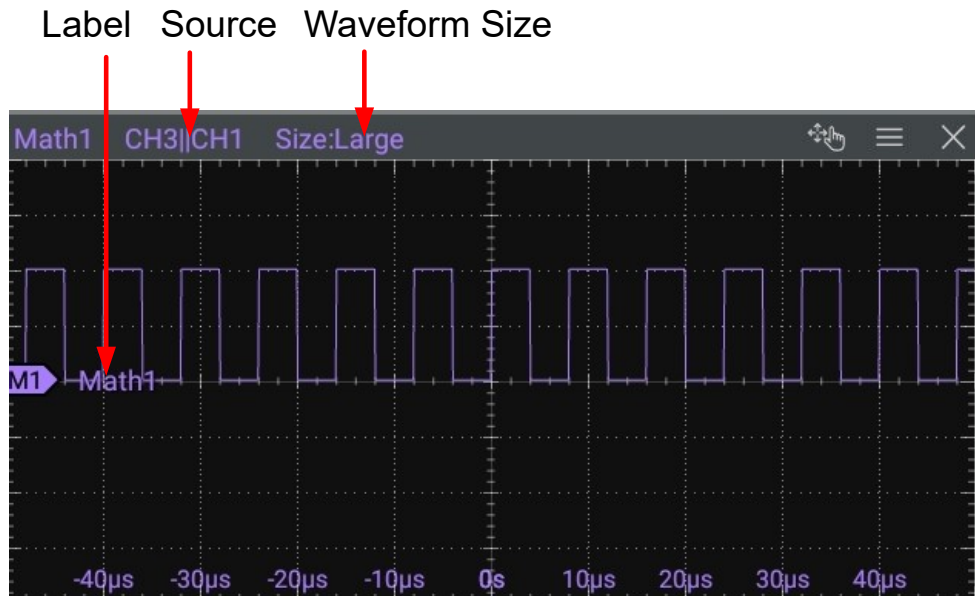

Figure 9.12 Operation Result Display Window

### Source

Click or tap the drop-down button of **SourceA** or **SourceB** to select analog channels CH1-CH4 or digital channels D0-D15 (available only when the digital channel probe is connected). When a source channel is selected, the selected channel automatically switches to the ON state.

### Waveform Size

You can select "Small", "Medium", or "Large" as the waveform display mode.



### Offset

Offset is used to set the vertical offset of the operation result. You can set the vertical offset in the following ways.

- In **Math** menu, rotate the corresponding multifunction knob on the front panel or click or tap the icon at the right side of the input field of **Offset** to increase or decrease the offset value. You can also click or tap the input field to input a specific value with the displayed numeric keypad.
- Close the menu and then adjust the vertical offset with the drag gesture on the touch screen. You can also rotate the multifunction knob 2 on the front panel to adjust the vertical offset. Please refer to *Front Panel* to configure the front-panel multifunction knobs.

### Sensitivity

Sets the sensitivity of the digital signal converted from the analog signal on the source. Click or tap the **Sensitivity** input field to set the sensitivity with the pop-up numeric keypad or use the corresponding multifunction knob to set the value. For details, refer to *Parameter Setting Method*.

### Waveform

This oscilloscope provides Main and Zoom for the measurement range.

- **Main** indicates that the measurement range is within the main time base region.
- **Zoom** indicates that the measurement range is within the zoomed time base region.

To use "Zoom", first enable the *Zoom Mode (Delayed Sweep)* in the *Horizontal System* menu.

### Threshold

Click or tap the threshold input field of the specified channel and use the pop-up numeric keypad to set the threshold or use the corresponding multifunction knob to set the value.

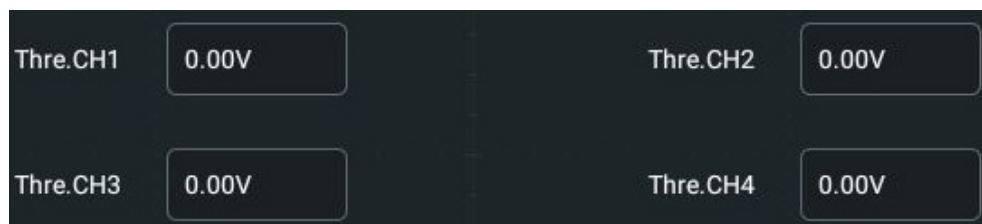

#### TIP

For the threshold of digital channels (D0-D15), refer to *Digital Channel*.

### Label

It is used to set the label for the math operation results. For setting methods, refer to descriptions in *To Turn the Channel Label Display On/Off*.

### Grid

For setting methods, refer to the descriptions in *To Set the Screen Grid*.

## 9.5 Digital Filter

In the **Math** menu, click or tap the **Operator** drop-down button to select the desired math operation. The digital filters supported by this oscilloscope include: low-pass filter, high-pass filter, band-pass filter, and band-stop filter.

- **LowPass** only allows the signals whose frequencies are lower than the current upper limit frequency to pass.
- **HighPass** only allows the signals whose frequencies are higher than the current lower limit frequency to pass.
- **BandPass** only allows the signals whose frequencies are higher than the current lower limit frequency and lower than the current upper limit frequency to pass.
- **BandStop** only allows the signals whose frequencies are lower than the current lower limit frequency or higher than the current upper limit frequency to pass.

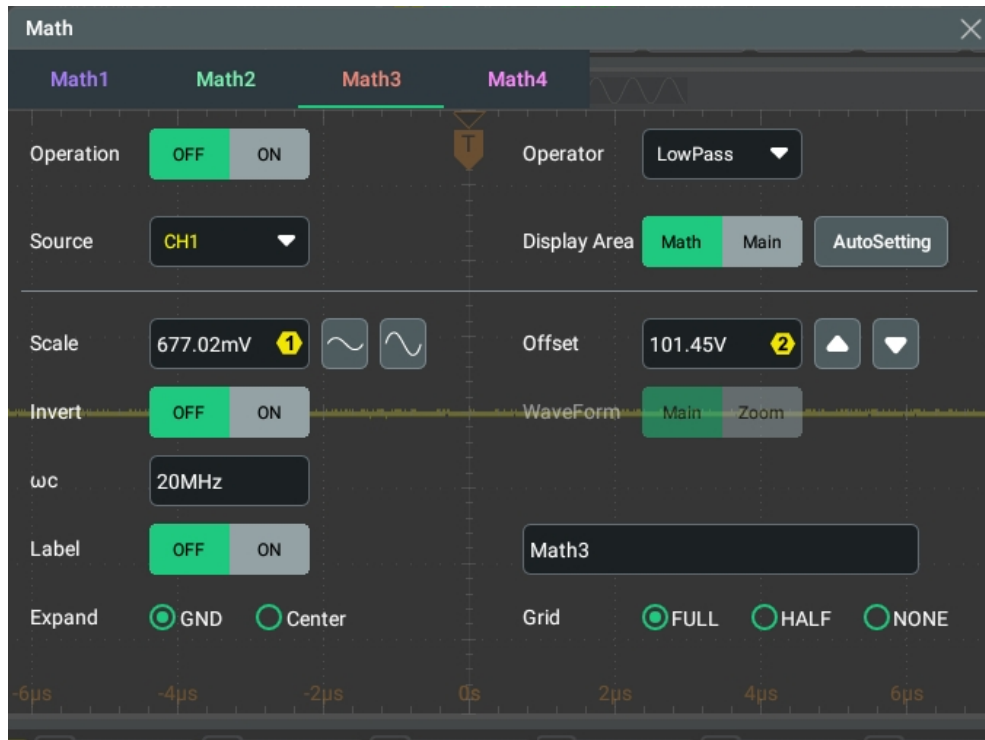

Figure 9.13 Digital Filter Menu

### Operation Result Display Window

Click or tap the **Operation** on/off switch to enable , the display of the operation result window. The source and the vertical scale parameters are displayed at the top of the window as shown in the figure below.

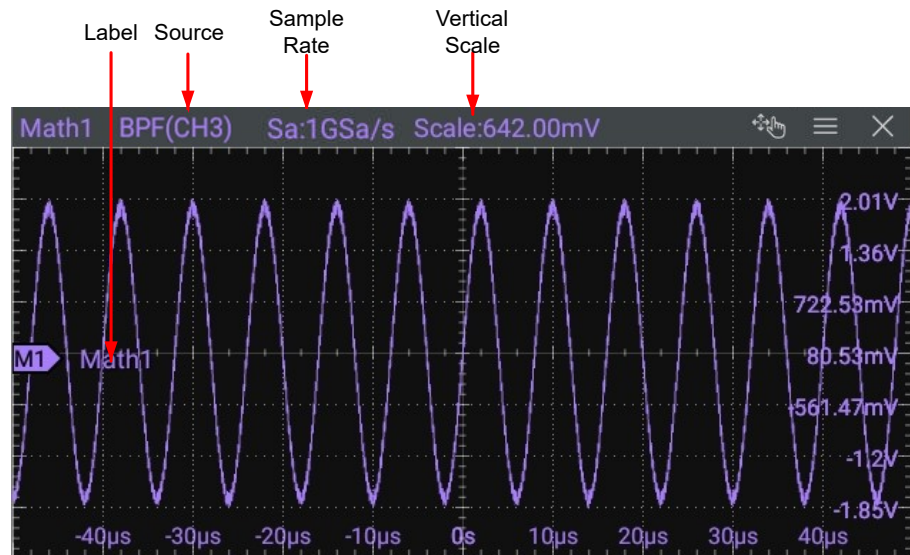

Figure 9.14 Operation Result Display Window

### Source

Click or tap the **Source** drop-down button to select from CH1-CH4 or Ref1-Ref10. When a source channel is selected, the selected channel automatically switches to the ON state.

### TIP

Besides CH1-CH4 and Ref1-Ref10, the Math2 source can be set to Math1; the Math3 source can be set to Math1 or Math2; the Math4 source can be set to Math1, Math2, or Math3. Selecting a Math automatically enables its window display and sets its Operation on/off switch to ON.

### Auto Set

Click or tap **AutoSetting** to adjust the vertical scale and the offset of the operation results to the optimal value according to the current configuration for you to better observe.

### Scale

Scale is used to set the vertical scale of the operation result. You can set the vertical scale in the following ways.

- In the **Math** menu, rotate the corresponding multifunction knob on the front panel or click or tap the icon at the right side of the input field of **Scale** to increase or decrease the scale value. You can also click or tap the input field to input a specific value with the displayed numeric keypad.
- Close the menu and then adjust the vertical scale with the pinch&stretch gesture on the touch screen. You can also rotate the multifunction knob 1 on the front

panel to adjust the vertical scale. Please refer to *Front Panel* to configure the front-panel multifunction knobs.

### Offset

Offset is used to set the vertical offset of the operation result. You can set the vertical offset in the following ways.

- In **Math** menu, rotate the corresponding multifunction knob on the front panel or click or tap the icon at the right side of the input field of **Offset** to increase or decrease the offset value. You can also click or tap the input field to input a specific value with the displayed numeric keypad.
- Close the menu and then adjust the vertical offset with the drag gesture on the touch screen. You can also rotate the multifunction knob 2 on the front panel to adjust the vertical offset. Please refer to *Front Panel* to configure the front-panel multifunction knobs.

### Invert

Invert is used to enable or disable the inverted display of the waveform. When the Invert function is disabled, the waveform is displayed normally; when enabled, the voltage values of the displayed waveform are inverted.

### Waveform

This oscilloscope provides Main and Zoom for the measurement range.

- **Main** indicates that the measurement range is within the main time base region.
- **Zoom** indicates that the measurement range is within the zoomed time base region.

To use "Zoom", first enable the *Zoom Mode (Delayed Sweep)* in the *Horizontal System* menu.

### Frequency Limit

- **LowPass**: click or tap the **ωc** input field and use the pop-up numeric keypad to set the upper limit frequency or use the corresponding multifunction knob to set the value.
- **HighPass**: click or tap the **ωc** input field and use the pop-up numeric keypad to set the lower limit frequency or use the corresponding multifunction knob to set the value.
- **BandPass**: click or tap the **ωc1** input field and use the pop-up numeric keypad to set the lower limit frequency. Click or tap the **ωc2** input field and use the pop-up numeric keypad to set the upper limit frequency. You can also use the corresponding multifunction knob to set the lower/upper limit frequency.

- **BandStop:** click or tap the **wc1** input field and use the pop-up numeric keypad to set the lower limit frequency. Click or tap the **wc2** input field and use the pop-up numeric keypad to set the upper limit frequency. You can also use the corresponding multifunction knob to set the lower/upper limit frequency.

The settable ranges of the upper and lower limit frequencies are related to the Math sample rate (displayed at the top of the screen when the Math function is enabled). The sample rate of the analog channel or the changes of the memory depth can affect the Math sample rate.

### Label

It is used to set the label for the math operation results. For setting methods, refer to descriptions in *To Turn the Channel Label Display On/Off*.

### Expand

The oscilloscope supports two vertical expansion modes: GND (default) and Center.

- **GND:** When the vertical scale is changed, the math operation waveform will expand or compress about the ground level of the signal.
- **Center:** When the vertical scale is changed, the math operation waveform will expand or compress about the center of the display.



### Grid

For setting methods, refer to the descriptions in *To Set the Screen Grid*.

## 10 Measurements

This series oscilloscope provides the quick measurements after "Auto" is selected, auto measurements for 41 waveform parameters, as well as the cursor measurement function.

### 10.1 Auto Scale

When the oscilloscope is correctly connected and has detected a valid input signal, click or tap the function navigation icon  > **Auto** or press the front-panel  key to enable the waveform auto setting function and open the auto setting function menu.



- Click or tap the first icon, and then two periods of the signal are automatically displayed on the screen. Meanwhile, the system will make measurements for the "period" and "frequency" of the currently displayed waveform. The measurement results are displayed in the "Result" bar at the right side of the screen.
- Click or tap the second icon, and then multiple periods of the signal are automatically displayed on the screen. Meanwhile, the system will make measurements for the "period" and "frequency" of the currently displayed waveforms in multiple periods. The measurement results are displayed in the "Result" bar at the right side of the screen.
- Click or tap the third icon to enable the "rise time" measurement item. The measurement results are displayed in the "Result" bar at the right side of the screen. By default, it is intended for the fast edge signal.
- Click or tap the fourth icon to enable the "fall time" measurement item. The measurement results are displayed in the "Result" bar at the right side of the screen. By default, it is intended for the fast edge signal.
- Click or tap the fifth icon to cancel the auto setting and recovers to the parameter settings prior to clicking or tapping **Auto**.
- Click or tap the sixth icon to enter the **Auto Config** sub-menu under the **Utility** menu. For details, please refer to *Auto Config*.



#### TIP

The waveform auto setting function requires that the frequency of the signal should be greater than or equal to 35 Hz, and the amplitude greater than or equal to 10 mV. If those conditions are not met, the waveform auto setting function may be invalid.



## 10.2 Auto Measurements

You can enter the **Measure** menu in the following ways.

- Click or tap the function navigation icon  at the lower-left corner of the screen, and then select **Measure** to enter the Measure menu.
- Press the front-panel  key to enter the Measure menu.
- Click or tap the **Measure** button on the toolbar to enter the Measure menu.
- In *Vertical System* menu, click or tap the **Measure** button to enter the Measure menu.

### 10.2.1 Measurement Parameter

This oscilloscope allows you to set the measurement source, enable or disable the all measurement function, the statistical function, and etc. You can make quick measurements for many waveform parameters. The measurement results will be displayed in the **Result** sidebar at the right section of the screen.

#### TIP

If there is no signal input for the current source or the measurement result is not within the valid range (too large or too small), then the measurement results are invalid, and "\*\*\*\*\*" is displayed on the screen. Please re-input the signal or set the signal.



#### 10.2.1.1 Time Parameters

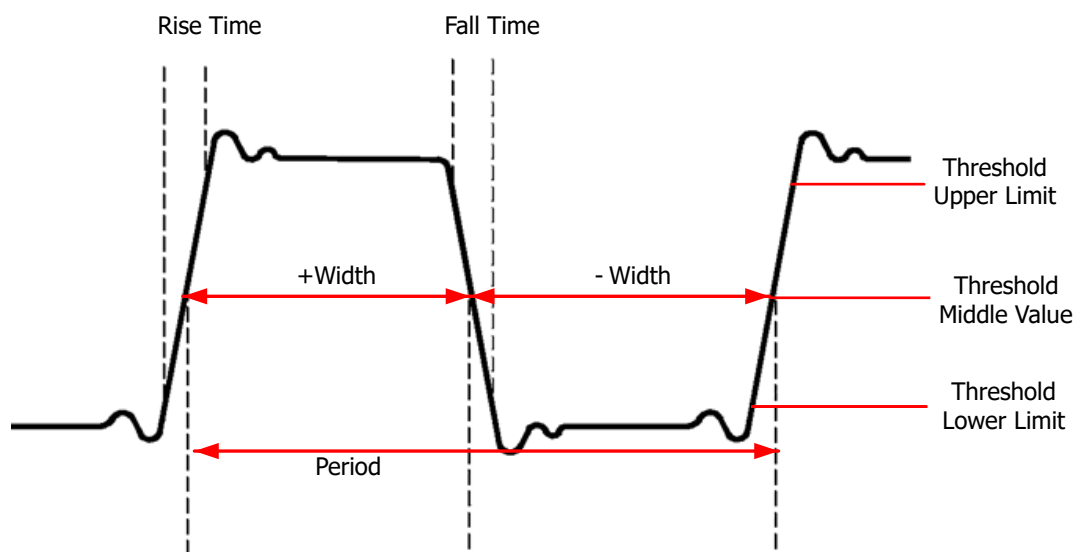

Figure 10.1 Time Parameters

- **Period:** defined as the time between the middle threshold points of two consecutive, like-polarity edges.
- **Frequency:** defined as the reciprocal of period.
- **Rise Time:** indicates the time for the signal amplitude to rise from the threshold lower limit to the threshold upper limit.
- **Fall Time:** indicates the time for the signal amplitude to fall from the threshold upper limit to the threshold lower limit.
- **+Width:** indicates the time between the threshold middle value of a rising edge to the threshold middle value of the next falling edge.
- **-Width:** indicates the time between the threshold middle value of a falling edge to the threshold middle value of the next rising edge.
- **+Duty:** indicates the ratio of the positive pulse width to the period.
- **-Duty:** indicates the ratio of the negative pulse width to the period.
- **Tvmax:** indicates the time that corresponds to the maximum value of the waveform ( $V_{max}$ ).
- **Tvmin:** indicates the time that corresponds to the minimum value of the waveform ( $V_{min}$ ).

The default values for threshold upper limit, threshold middle value, and threshold lower limit are 90%, 50%, and 10%, respectively.

### 10.2.1.2 Count Values

The default values for threshold upper limit and threshold lower limit are 90% and 10%, respectively.

#### Positive Pulse Count

It is specified as the number of positive pulses that rise from under the threshold lower limit to above the threshold upper limit.

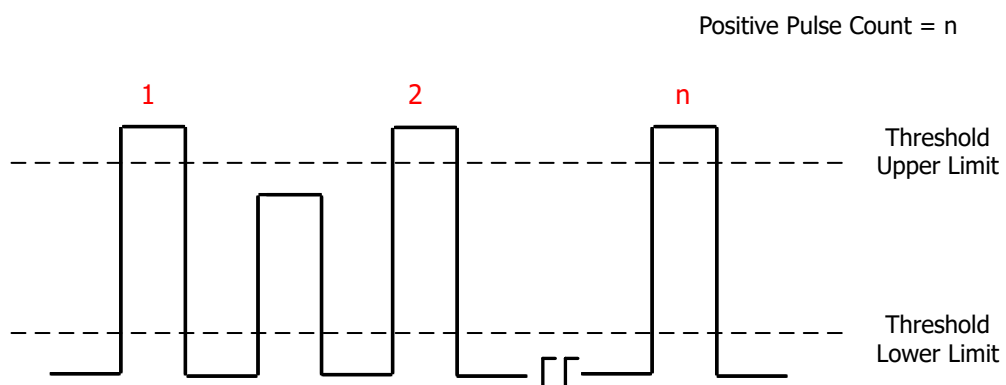

### Negative Pulse Count

It is specified as the number of negative pulses that fall from above the threshold upper limit to below the threshold lower limit.

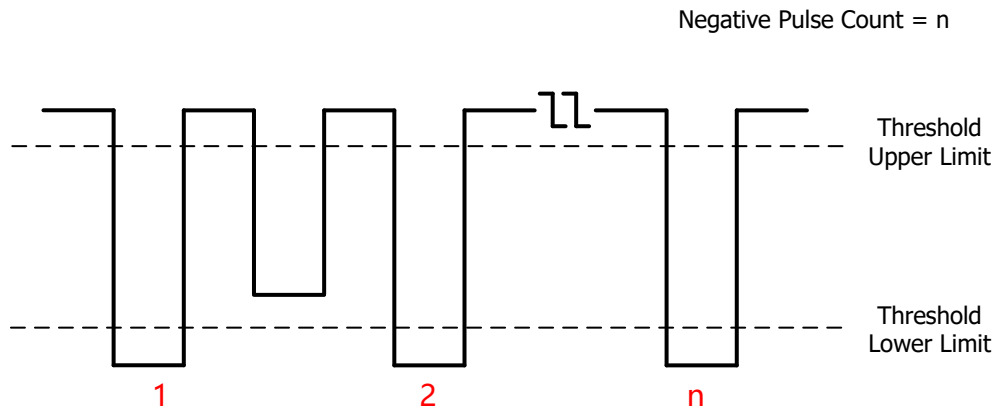

### Rising Edge Count

It is specified as the number of rising edges that rise from under the threshold lower limit to above the threshold upper limit.

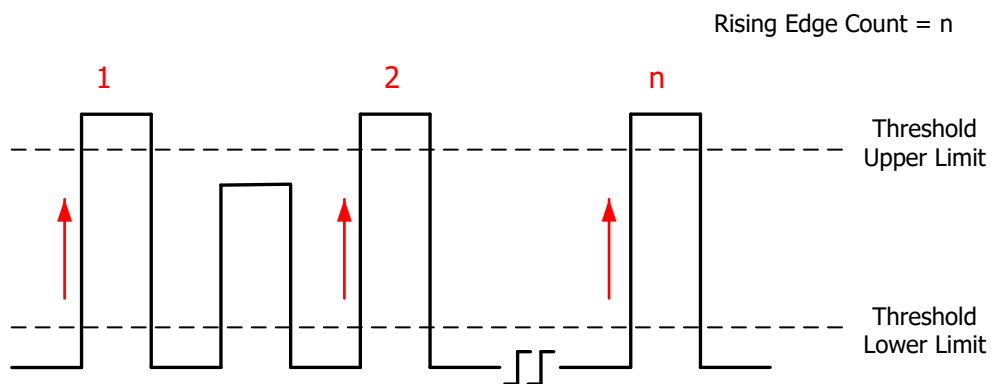

### Falling Edge Count

It is specified as the number of falling edges that fall from above the threshold upper limit to below the threshold lower limit.

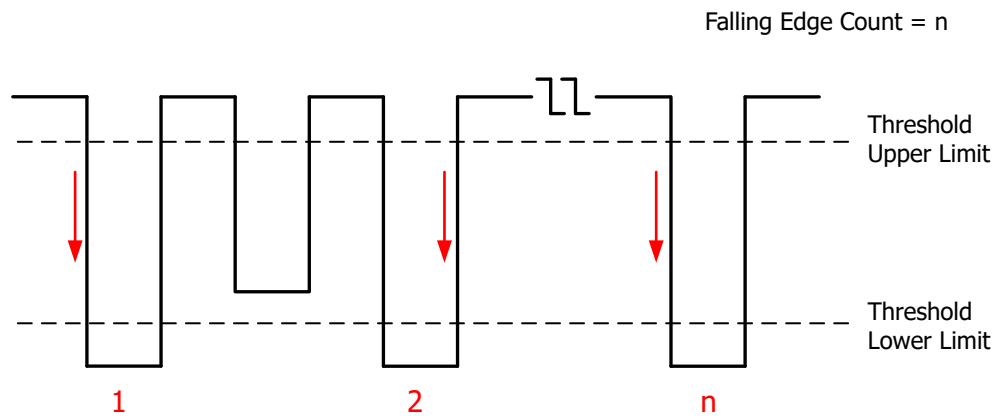

### 10.2.1.3 Delay and Phase Parameters

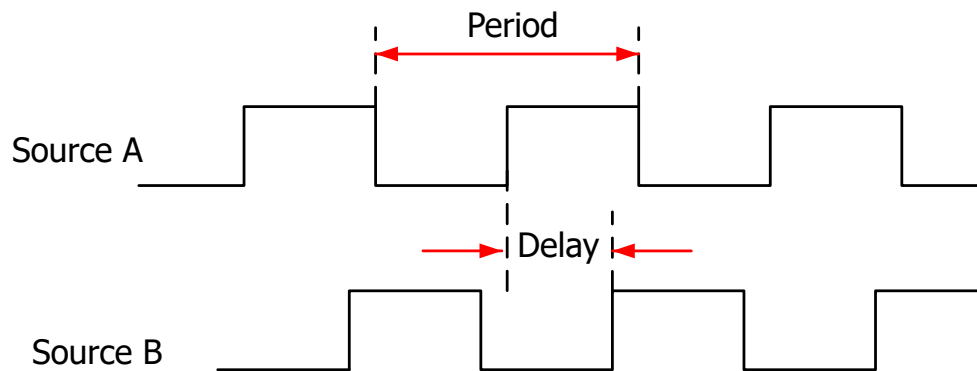

**Figure 10.2 Delay and Phase Parameters**

1. **Delay(r-r)**: indicates the time difference between the threshold middle values of the rising edge of Source A and that of Source B. Negative delay indicates that the rising edge of Source A occurred after that of Source B.
2. **Delay(f-f)**: indicates the time difference between the threshold middle values of the falling edge of Source A and that of Source B. Negative delay indicates that the falling edge of Source A occurred after that of Source B.
3. **Delay(r-f)**: indicates the time difference between the threshold middle values of the rising edge of Source A and the falling edge of Source B. Negative delay indicates that the rising edge of Source A occurred after the falling edge of Source B.
4. **Delay(f-r)**: indicates the time difference between the threshold middle values of the falling edge of Source A and the rising edge of Source B. Negative delay indicates that the falling edge of Source A occurred after the rising edge of Source B.
5. **Phase(r-r)**: indicates the phase deviation between the threshold middle values of the rising edge of Source A and that of Source B. The phase formula is as follows:

$$PhaseA_{RB_R} = \frac{DelayA_{RB_R}}{Period_{sourceA}} \times 360^\circ$$

Wherein,  $PhaseA_{RB_R}$  represents Phase(r-r),  $DelayA_{RB_R}$  represents Delay(r-r), and  $Period_{sourceA}$  represents the period of Source A.

- 6. Phase(f-f):** indicates the phase deviation between the threshold middle values of the falling edge of Source A and that of Source B. The phase formula is as follows:

$$PhaseA_{FB_F} = \frac{DelayA_{FB_F}}{Period_{sourceA}} \times 360^\circ$$

Wherein,  $PhaseA_{FB_F}$  represents Phase (f-f),  $DelayA_{FB_F}$  represents Delay(f-f), and  $Period_{sourceA}$  represents the period of Source A.

- 7. Phase(r-f):** indicates the phase deviation between the threshold middle values of the rising edge of Source A and the falling edge of Source B. The phase formula is as follows:

$$PhaseA_{RB_F} = \frac{DelayA_{RB_F}}{Period_{sourceA}} \times 360^\circ$$

Wherein,  $PhaseA_{RB_F}$  represents Phase (r-f),  $DelayA_{RB_F}$  represents Delay(r-f), and  $Period_{sourceA}$  represents the period of Source A.

- 8. Phase(f-r):** indicates the phase deviation between the threshold middle values of the falling edge of Source A and the rising edge of Source B. The phase formula is as follows:

$$PhaseA_{FB_R} = \frac{DelayA_{FB_R}}{Period_{sourceA}} \times 360^\circ$$

Wherein,  $PhaseA_{FB_R}$  represents Phase (f-r),  $DelayA_{FB_R}$  represents Delay(f-r), and  $Period_{sourceA}$  represents the period of Source A.



**TIP**

- Source A and Source B can be any channel among CH1-CH4, D0-D15, and Math1-Math4.
- The default threshold middle value is 50%.

### 10.2.1.4 Voltage Parameters

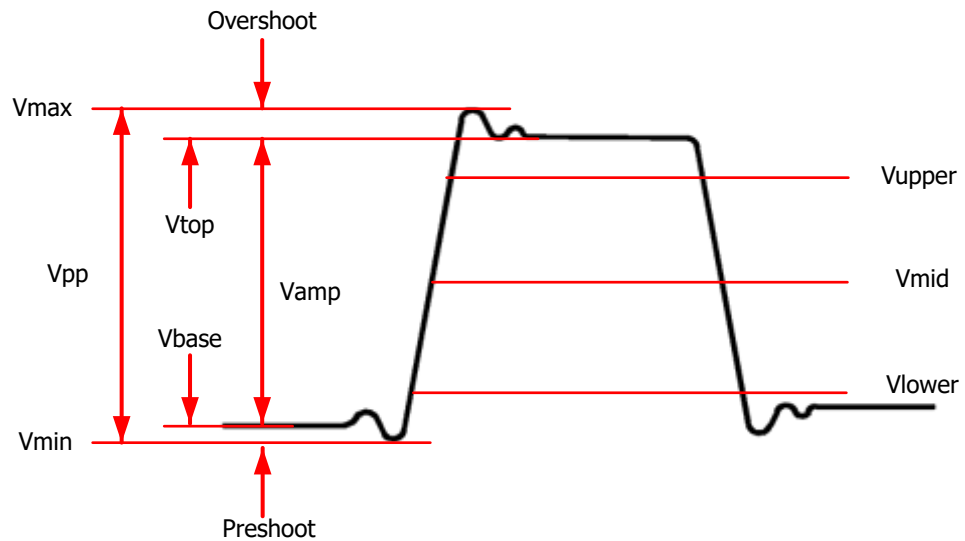

Figure 10.3 Voltage Parameters

1.  **$V_{max}$** : indicates the voltage value from the highest point of the waveform to the GND.
2.  **$V_{min}$** : indicates the voltage value from the lowest point of the waveform to the GND.
3.  **$V_{pp}$** : indicates the voltage value from the highest point to the lowest point of the waveform.
4.  **$V_{top}$** : indicates the voltage value from the flat top of the waveform to the GND.
5.  **$V_{base}$** : indicates the voltage value from the flat base of the waveform to the GND.
6.  **$V_{amp}$** : indicates the voltage value from the top of the waveform to the base of the waveform.
7.  **$V_{upper}$** : indicates the actual voltage value that corresponds to the threshold maximum value.
8.  **$V_{mid}$** : indicates the actual voltage value that corresponds to the threshold middle value.
9.  **$V_{lower}$** : indicates the actual voltage value that corresponds to the threshold minimum value.
10.  **$V_{avg}$** : indicates the arithmetic average value on the whole waveform or in the gating area. The formula is shown as follows:

$$Average = \frac{\sum_{i=1}^n x_i}{n}$$

Wherein,  $x_i$  is the  $i$ th point, and  $n$  is the number of points being measured.

- 11. VRMS:** indicates the root mean square value on the whole waveform or in the gating area. The formula is as follows:

$$RMS = \sqrt{\frac{\sum_{i=1}^n x_i^2}{n}}$$

Wherein,  $x_i$  is the measurement result of the  $i$ th point, and  $n$  is the number of points being measured.

- 12. Per.VRMS:** indicates the root mean square value within a period. The formula is as shown above.
- 13. Overshoot:** indicates the ratio of the difference between the maximum value and the top value of the waveform to the amplitude value.
- 14. Preshoot:** indicates the ratio of the difference between the minimum value and the base value of the waveform to the amplitude value.
- 15. AC RMS:** indicates the root-mean-square value of the waveforms, with the DC component removed. The formula is shown as follows:

$$Std.Dev = \sqrt{\frac{\sum_{i=1}^n (x_i - Average)^2}{n}}$$

Wherein,  $x_i$  is the amplitude of the  $i$ th point, *Average* is the waveform average value, and  $n$  is the number of points being measured.

#### 10.2.1.5 Other Parameters

- **Positive Slew Rate:** On the rising edge, first calculate the difference between the high value and the low value, then use the difference to divide the corresponding time value to obtain the positive slew rate.
- **Negative Slew Rate:** On the falling edge, first calculate the difference between the low value and the high value, then use the difference to divide the corresponding time value to obtain the negative slew rate.
- **Area:** indicates the area of the whole waveform within the screen. The unit is V\*s. The area of the waveform above the zero reference (namely the vertical offset) is positive, and the area of the waveform below the zero reference is negative. The area measured is the algebraic sum of the area of the whole waveform within the screen.
- **Period Area:** indicates the area of the first period of waveform on the screen. The unit is V\*s. The area of the waveform above the zero reference (namely the vertical offset) is positive, and the area of the waveform below the zero

reference is negative. The area measured is the algebraic sum of the whole period area.

## 10.2.2 Select the Measurement Item

In the **Measure** menu, click or tap **Vertical**, **Horizontal**, or **Other** to go to the desired menu. You can also slide to select the measurement item to enter the corresponding interface, as shown in *Figure 10.4*, *Figure 10.5*, and *Figure 10.6*. Click or tap any of the measurement items to enable the measurements. This series of oscilloscope allows you to enable measurements of up to 14 items at the same time.

### TIP

You can also refer to *Multi-pane Windowing* to enable all measurements.

- **Vertical:** Vmax, Vmin, Vpp, Vtop, Vbase, Vamp, Vupper, Vmid, Vlower, Vavg, VRMS, Per. VRMS, Overshoot, Preshoot, Area, Per.Area, and AC.RMS.

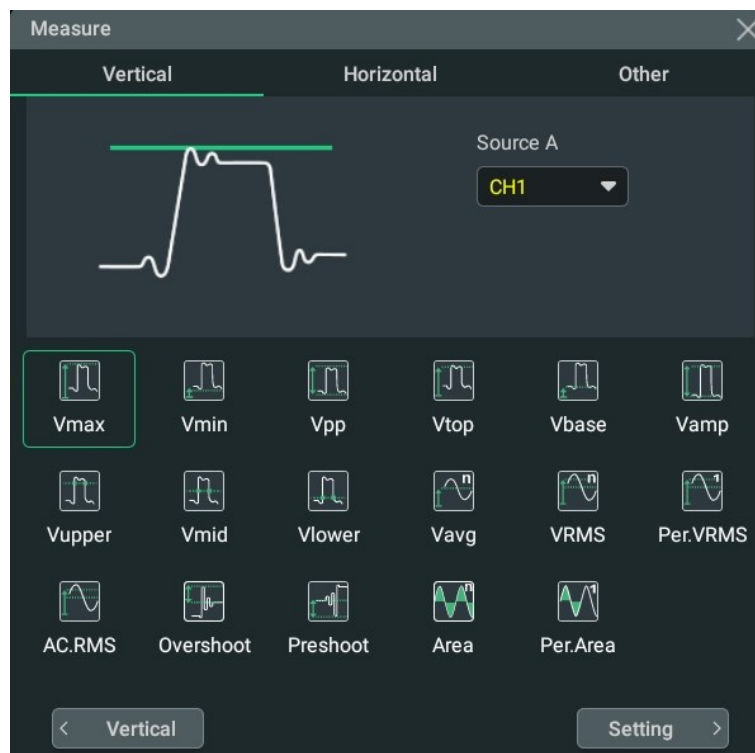

**Figure 10.4 Vertical Measurement Items**

- **Horizontal:** Period, Frequency, Rise Time, Fall Time, +Width, -Width, +Duty, -Duty, Positive Pulse Count, Negative Pulse Count, Rising Edge Count, Falling Edge Count, T<sub>vmax</sub>, T<sub>vmin</sub>, +Slew Rate, and -Slew Rate.

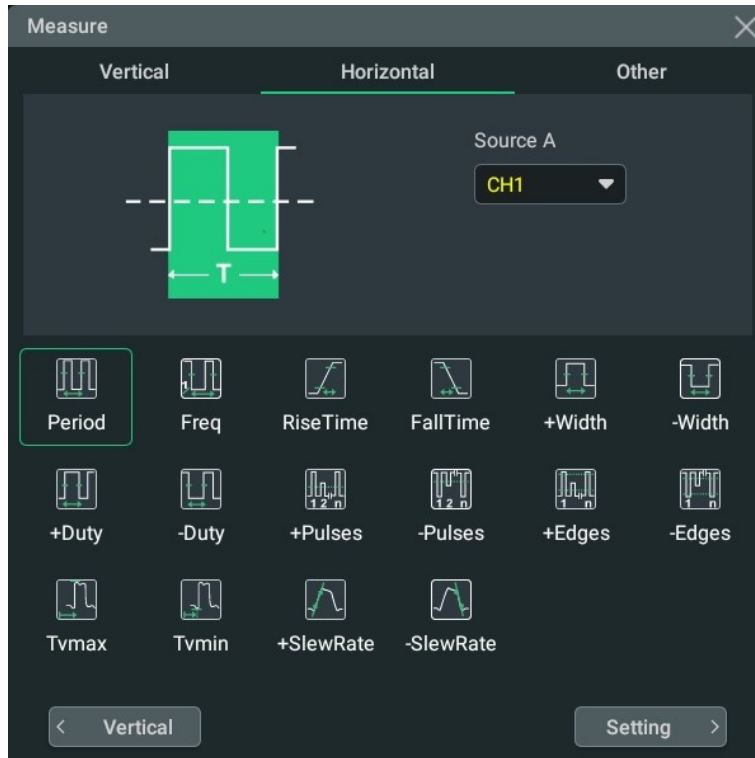

Figure 10.5 Horizontal Measurement Items

- **Other:** Delay (r-r), Delay (r-f), Delay (f-r), Delay (f-f), Phase (r-r), Phase (r-f), Phase(f-r), and Phase (f-f).

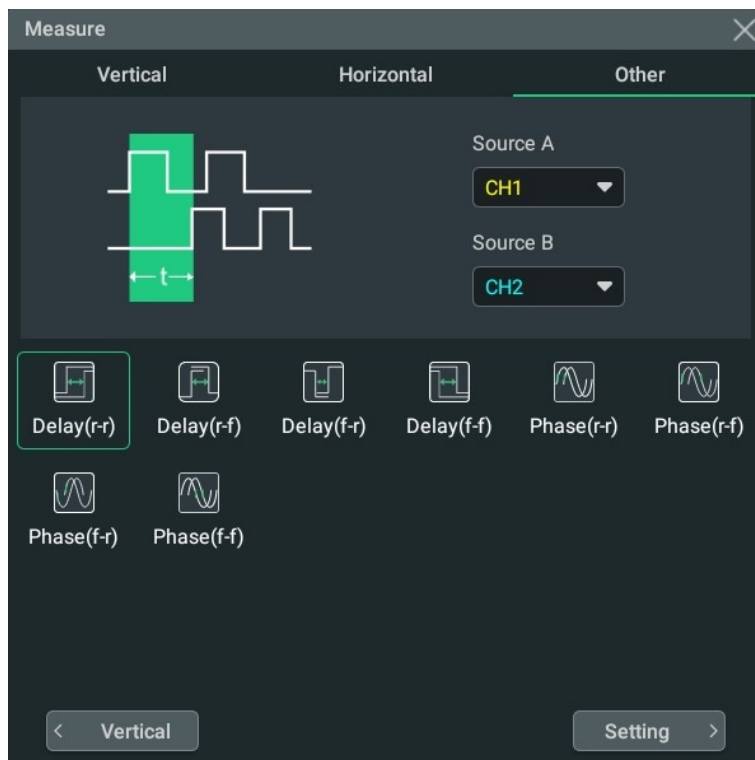

Figure 10.6 Other Measurement Items

## 10.2.3 Measurement Settings

In the **Measure** menu, click or tap the **Setting** button to enter the measurement setting menu.

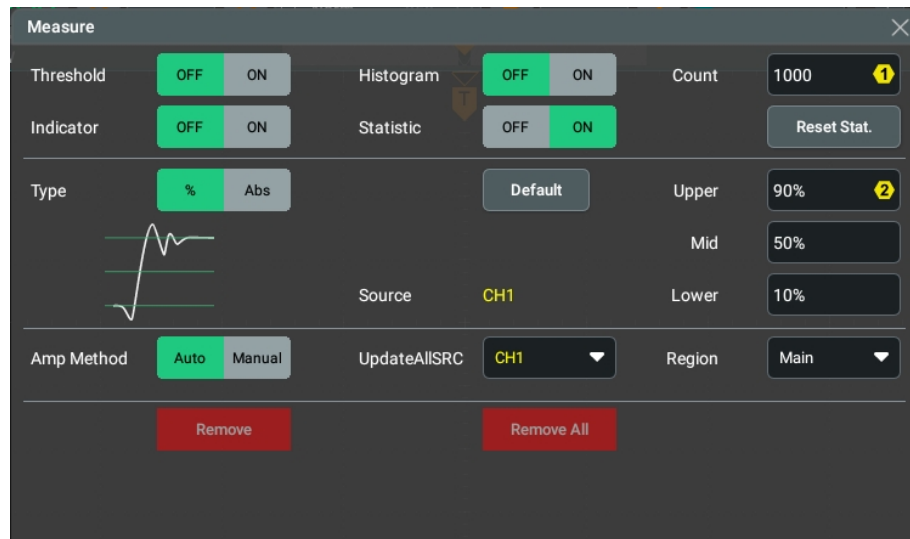

Figure 10.7 Measurement Settings Menu

### Histogram

Click or tap the **Histogram** on/off switch to enable or disable the histogram function. After the histogram function is enabled, the Measure Histogram view is displayed on the screen, as shown in the figure below. The histogram analysis result label is displayed in the **Result** sidebar (refer to *Histogram Analysis Results*).

### NOTE

Add at least one measurement item (*Select the Measurement Item*) before enabling the Measure Histogram function.



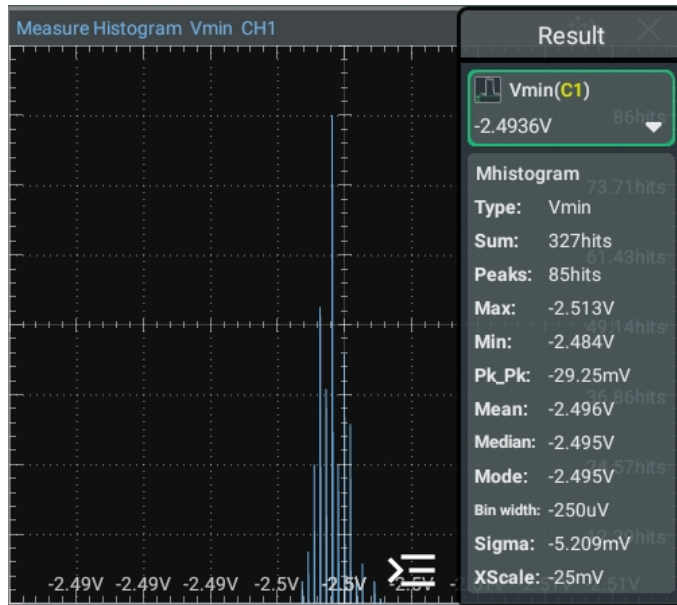

After the Measure Histogram function is enabled, please refer to *Select the Measurement Item* to add new measurement parameter. The new parameter will be used as the measurement item. In the "Result" sidebar, you can also click or tap the label of the added measurement parameter (e.g. "Vpp" and "Vmin") to change the measurement item.

### Indicator

Click or tap the **Indicator** on/off switch to enable or disable the indicator.

If enabled, one or more cursors will be displayed on the screen. Before enabling the indicator, you need to enable at least one auto measurement parameter and the number of cursors will change with the measurement parameter enabled.

### TIP

When no measurement parameter is selected or there is no source input, the indicator is not available. The indicator changes when the waveform is expanded or compressed horizontally.

### Measurement Threshold

- First, select **%** or **Abs** as the display type.
- Click or tap the input field of **Upper** and use the pop-up numeric keypad to set the upper limit of the measurement or use the corresponding multifunction knob to set the value. When the upper limit is set to be smaller than or equal to the current middle value, a prompt message "Set at lower limit" is displayed. Then, the oscilloscope will automatically adjust the upper limit and make it greater than the middle value. By default, it is 90%. The default absolute value varies with the vertical setting of the channel.
- Click or tap the input field of **Mid** and use the pop-up numeric keypad to set the middle value of the measurement or use the corresponding multifunction knob to set the value. The middle value is limited by the settings of the upper limit

and lower limit. By default, it is 50%. The default absolute value varies with the vertical setting of the channel.

- Click or tap the input field of **Lower** and use the pop-up numeric keypad to set the lower limit of the measurement or use the corresponding multifunction knob to set the value. When the lower limit is set to be greater than or equal to the current middle value, a prompt message "Set at upper limit" is displayed. Then, the oscilloscope will automatically adjust the lower limit and make it smaller than the middle value. By default, it is 10%. The default absolute value varies with the vertical setting of the channel.

Click or tap the ON/OFF tab for **Threshold** to enable or disable the threshold settings.



#### TIP

Modifying the threshold will affect the measurement results of time, delay, and phase parameters.

#### Measurement Range

Click or tap the drop-down button of the **Region** to select "Main", "Zoom" or "Cursor".

- **Main:** indicates that the measurement range is within the main time base region.
- **Zoom:** indicates that the measurement range is within the zoomed time base region.
- **Cursor:** indicates that the measurement range is the region between CursorA and CursorB. When **Region** is set to "Cursor", CursorA and CursorB will be displayed on the screen. At this time, click or tap the input field of **CursorA** and **CursorB** respectively and use the pop-up numeric keypad to modify the cursor position and determine the measurement range. When **CursorAB** is enabled, the span of CursorA and CursorB is fixed. You can adjust both cursors simultaneously and determine the measurement range.



#### TIP

To use "Zoom", you need to enable the Delayed Sweep first.

#### Amplitude Measurement Method

Click or tap **Auto** or **Manual** as the amplitude measurement method, which affects the measurement method for the top and base values

If you select "Manual", set the following parameters:

- Click or tap the **Top** toggle button to select **Histogram** or **Max-Min** as the top value measurement method.
- Click or tap the **Base** toggle button to select **Histogram** or **Max-Min** as the base value measurement method.

**TIP**

If you select "Manual" for the amplitude method, the measurement results of other parameters may be affected.

"Histogram" and "Max-Min" are the internal measurement algorithm for the oscilloscope. The "Histogram" method mentioned above is different from the Histogram function of the oscilloscope.

**Modify All Measurement Sources**

Click or tap the **UpdateAllSRC** drop-down button to select the desired source, and then all sources of added measurement items are switched to the currently selected source. Available source channel include analog channels CH1-CH4, digital channels D0-D15 and Math1-Math4.

**Remove the Measurement Results**

Refer to *Remove the Measurement Results*.

**Statistics**

Click or tap the **Statistic** on/off switch to enable or disable the statistical result

display. You can also click or tap  at the lower-right of the measurement item in the "Result" sidebar to expand the label to display all the statistical items. Click or tap



to collapse the label. The figure below shows the displayed results after the **Statistic** of maximum measurement is enabled.



- Click or tap any measurement item in the "Result" sidebar at the right side of the screen and a window is displayed. Click or tap **Reset Stat.** to clear the history statistics data and makes statistics again. You can also click or tap **Reset Stat.** in the measurement setting menu.
- Click or tap the input field of **Count** and use the pop-up numeric keypad to set the count value. You can also use the corresponding multifunction knob to set the value. Its range is from 2 to 100000. Its default value is 1000.

**10.2.4 Remove the Measurement Results**

This oscilloscope allows you to delete the measurement results of the parameters.

- In **Measure** setting menu, click or tap **Remove** to delete the currently selected measurement item that you've added; click or tap **Remove All** to delete all the displayed measurement items.
- Click or tap any measurement item in the "Result" sidebar at the right side of the screen and a window is displayed. Click or tap **Remove** to delete the currently selected measurement item that you've added; click or tap **Remove All** to delete all the displayed measurement items.
- In the "Result" sidebar, select a measurement item and drag it to the right to delete it quickly

## 10.3 Cursor Measurements

Cursor measurement can measure the X axis values (e.g. Time) and Y axis values (e.g. Voltage) of the selected waveform. Before making cursor measurements, connect the signal to the oscilloscope to acquire stable display. The cursor measurement function provides the following two cursors.

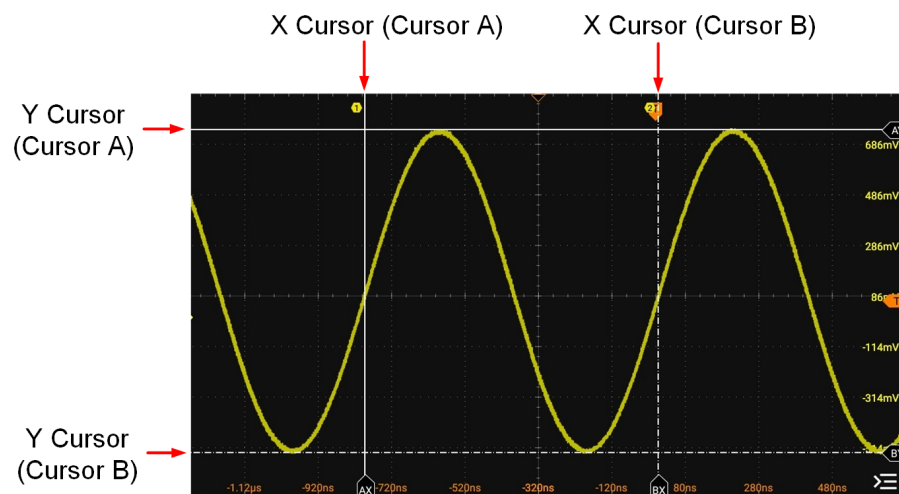



Figure 10.8 Cursors



- **X Cursor**
  - X cursor is a vertical solid/dotted line that is used to make horizontal adjustments. It can be used to measure time (s) and frequency (Hz).
  - Cursor A is a vertical solid line (AX is displayed at the bottom of the screen), and Cursor B is a vertical dotted line (BX is displayed at the bottom of the screen).
  - In the XY cursor mode, X cursor is used to measure the waveform amplitude of Source X.

- **Y Cursor**

Y cursor is a horizontal solid/dotted line that is used to make vertical adjustments. It can be used to measure amplitude (the unit is the same as that of the source channel amplitude).

- Cursor A is a horizontal solid line (  is displayed at the right section of the screen), and Cursor B is a horizontal dotted line (  is displayed at the right section of the screen).
- In XY cursor mode, Y cursor is used to measure the waveform amplitude of Source Y.

You can enable cursor measurements in the following ways.

- Click or tap the function navigation icon  > **Cursors** to enable cursor measurements.
- Click or tap the **Cursors** button on the toolbar to enable cursor measurements.
- Press the front-panel  key to enable cursor measurements.

The measurement results are displayed in the "Result" bar at the right side of the screen.

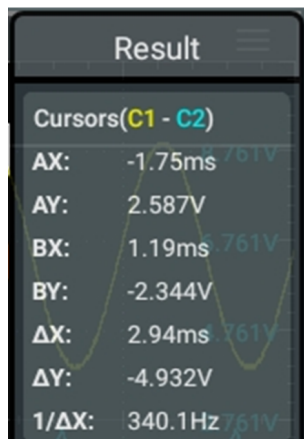

- AX: indicates the X value at Cursor A.
- AY: indicates the Y value at Cursor A.
- BX: indicates the X value at Cursor B.
- BY: indicates the Y value at Cursor B.
- ΔX: indicates the horizontal spacing between Cursor A and Cursor B.
- ΔY: indicates the vertical spacing between Cursor A and Cursor B.

- $1/\Delta X$ : indicates the reciprocal of the horizontal spacing between Cursor A and Cursor B.

Click or tap the result bar and then select **Remove** or **Setting** in the pop-up window.

- Click or tap **Remove**. Then the cursor measurement will be disabled and the current cursor measurement results will be cleared.
- Click or tap **Setting**. Then the "Cursors" menu is displayed. You can select the cursor mode: Manual, Track, and XY.

### 10.3.1 Manual Mode

In the manual cursor mode, you can adjust the cursor manually to measure the value of the waveforms of the specified source at the current cursor. If the settings for the parameter such as the cursor type and measurement source are different, the measurement results will be different for cursor measurement.

In the **Cursors** menu, click or tap **Manual** for the **Mode** item to enable the Manual cursor measurement function. The measurement results are displayed in the "Result" bar at the right side of the screen. When you change the cursor position, the measurement results will be changed accordingly.

#### Select the Measurement Source

Click or tap the drop-down button of **Source** to select the desired channel (None, Analog Channel CH1-CH4 or Math1-Math4).

When a specified channel is selected as the source, the channel will be enabled automatically.

#### Select Cursor Type

Click or tap the **Select** toggle button to select "X" or "Y".

- **X**: It is a pair of vertical solid (Cursor A)/dotted (Cursor B) lines, used for measuring time parameters. The measurement results include AX, BX,  $\Delta X$ , and  $1/\Delta X$ .
- **Y**: It is a pair of horizontal solid (Cursor A)/dotted (Cursor B) lines, used for measuring voltage parameters. The measurement results include AY, BY, and  $\Delta Y$ .

#### Adjust Cursor Position

1. When "X" is selected, you can adjust the position of X cursor.

- Click or tap the input field of **AX** and use the pop-up numeric keypad to set the horizontal position of Cursor A (X cursors). The horizontal axis indicates time, and the unit of its setting value is the same as that of the horizontal unit. Its adjustable range is limited within the screen.
- Click or tap the input field of **BX** and use the pop-up numeric keypad to set the horizontal position of Cursor B (X cursors). The horizontal axis indicates time,

and the unit of its setting value is the same as that of the horizontal unit. Its adjustable range is limited within the screen.

- Click or tap the **AX BX** on/off switch to turn on/off adjusting the horizontal position of Cursor A and Cursor B (X cursors) simultaneously. The horizontal spacing between Cursor A and Cursor B (X cursors) remains unchanged.

2. When "Y" is selected, you can adjust the position of Y cursor.

- Click or tap the input field of **AY**, and then use the pop-up numeric keypad to set the vertical position of Cursor A (Y cursors). The vertical axis indicates voltage, and the unit of its setting value is the same as that of the vertical unit.
- Click or tap the input field of **BY** and use the pop-up numeric keypad to set the vertical position of Cursor B (Y cursor). The vertical axis indicates voltage, and the unit of its setting value is the same as that of the vertical unit.
- Click or tap the **AY BY** on/off switch to turn on/off adjusting the vertical position of Cursor A and Cursor B (Y cursors) simultaneously. The vertical spacing between Cursor A and Cursor B (Y cursors) remains unchanged.

You can also use the specified multifunction knob  to adjust the cursor position.

### Measurement Example

Measure the period of a sine wave by using the manual cursor measurement and auto measurement respectively. The measurement results are both 1 ms.

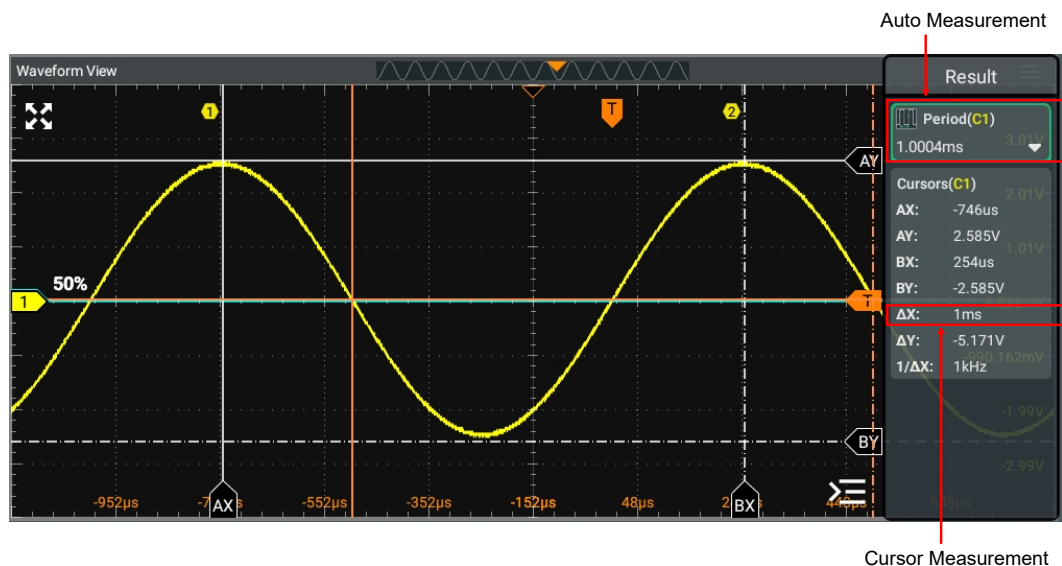

Figure 10.9 Manual Cursor Measurement Example

## 10.3.2 Track Mode

In the Track mode, you can adjust the two pairs of cursors (Cursor A and Cursor B) to measure the X and Y values on two different sources respectively. When the cursors

are moved horizontally/vertically, the markers will position on the waveform automatically. When the waveform is expanded or compressed horizontally/vertically, the markers will track the points being marked at the last adjustment of the cursors.

In the **Cursors** menu, click or tap **Track** for **Mode** to enable the Track cursor measurement function. The measurement results are displayed in the Result list at the right side of the screen.

### Select the Measurement Source

- Click or tap the drop-down button of **Source A** to select the desired channel (None, Analog Channel CH1-CH4, or Math1-Math4).
- Click or tap the drop-down button of **Source B** to select the desired channel (None, Analog Channel CH1-CH4, or Math1-Math4).

When a specified channel is selected as the source, the channel will be enabled automatically.

### Select the Track Mode

Click or tap the **Track** toggle button to select "X" or "Y" as the current track axis. By default, it is "X".

- **X:** When the X cursor position is adjusted, Y cursor will automatically track the intersection point between X cursor and source signal
- **Y:** When the Y cursor position is adjusted, X cursor will automatically track the intersection point between Y cursor and source signal.

### Adjust the Cursor Position

- When "X" is selected, you can adjust the position of X cursor.
  - Click or tap the input field of **AX** and use the pop-up numeric keypad to set the horizontal position of Cursor A (X cursors). Its adjustable range is limited within the screen.
  - Click or tap the input field of **BX** and use the pop-up numeric keypad to set the horizontal position of Cursor B (X cursors). Its adjustable range is limited within the screen.
  - Click or tap the **AX BX** on/off switch to turn on/off adjusting the horizontal position of Cursor A and Cursor B (X cursors) simultaneously. The horizontal spacing between Cursor A and Cursor B (X cursors) remains unchanged.
- When "Y" is selected, you can adjust the position of Y cursor.
  - Click or tap the input field of **AY**, and then use the pop-up numeric keypad to set the vertical position of Cursor A (Y cursors).
  - Click or tap the input field of **BY** and use the pop-up numeric keypad to set the vertical position of Cursor B (Y cursor).

- Click or tap the **AY BY** on/off switch to turn on/off adjusting the vertical position of Cursor A and Cursor B (Y cursors) simultaneously. The vertical spacing between Cursor A and Cursor B (Y cursors) remains unchanged.

You can also use the specified multifunction knob  to adjust the cursor position.

**Measurement Example**

Set the **Source A** to CH1, **Source B** to CH2, and **Track** to "X".

When the AX cursor position is adjusted, AY cursor will automatically track the intersection point between AX cursor and source signal (CH1); When the BX cursor position is adjusted, BY cursor will automatically track the intersection point between BX cursor and source signal (CH2). The measurement results are displayed in the Result list, as shown in *Figure 10.10*. Then, expand the waveforms horizontally, and you will find that the cursor will track the point that has been marked, as shown in *Figure 10.11*.

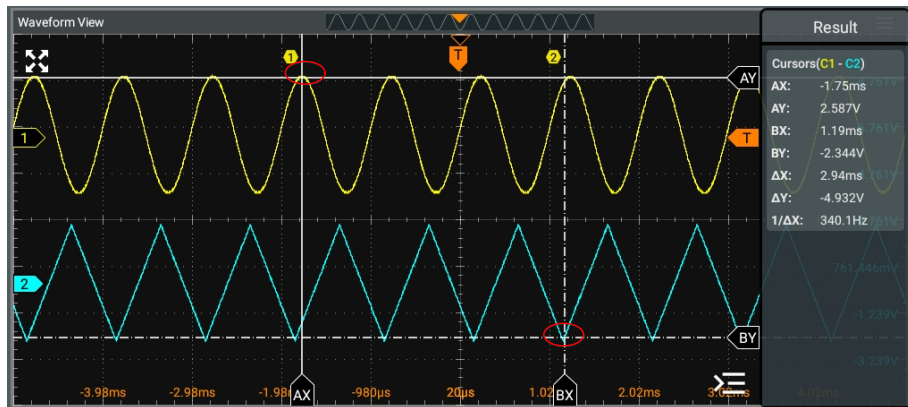

**Figure 10.10 Track Measurement (before Horizontal Expansion)**

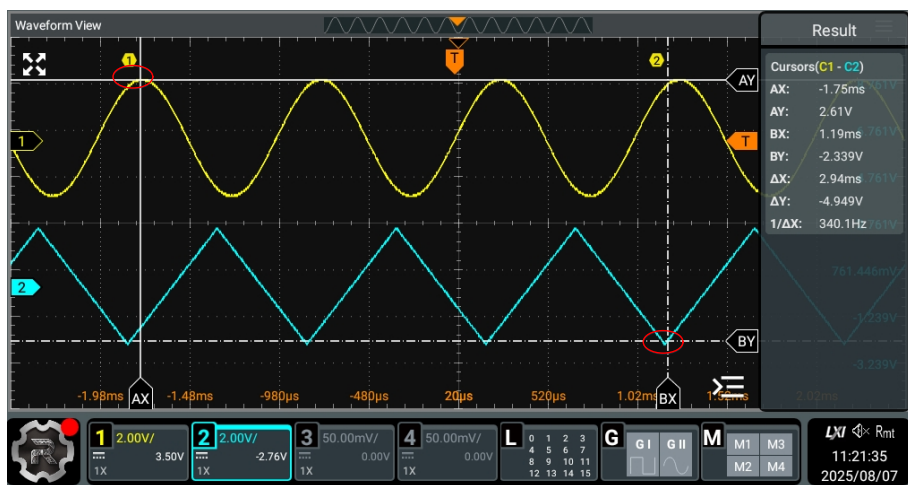

**Figure 10.11 Track Measurement (after Horizontal Expansion)**

### 10.3.3 XY Mode

In the **Cursors** menu, click or tap **XY** for **Mode** to enable the XY cursor measurement function. The measurement results are displayed in the Result list at the right side of the screen.

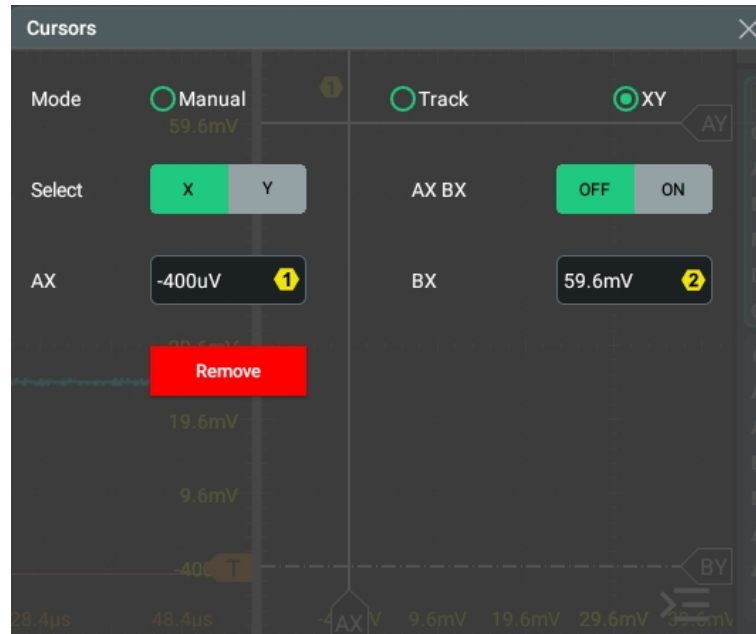

Figure 10.12 XY Mode Setting Menu



#### TIP

By default, XY mode is unavailable. It is available only when the horizontal time base mode is "XY". To enable the XY mode, please refer to *XY Mode*.

#### Adjust Cursor Position

- Click or tap to select the "X" tab under the **Select** menu item to set the X value for the specified cursor.
  - Click or tap the input field of **AX** and use the pop-up numeric keypad to set the X value at Cursor A.
  - Click or tap the input field of **BX** and use the pop-up numeric keypad to set the X value at Cursor B.
  - Click or tap the **AX BX** on/off tab to turn on/off adjusting the X value at Cursor A and the X value at Cursor B simultaneously.
- Click or tap to select "Y" under the **Select** item to set the Y value for the specified cursor.
  - Click or tap the input field of **AY** and use the pop-up numeric keypad to set the Y value at Cursor A.

- Click or tap the input field of **BY** and use the pop-up numeric keypad to set the Y value at Cursor B.
- Click or tap the **AY BY** on/off tab to turn on/off adjusting the Y value at Cursor A and the Y value at Cursor B simultaneously.

You can also use the front-panel multifunction knob  to adjust the cursor position. To configure the multifunction knobs, please refer to *Front Panel*. During the adjustment, the measurement results will change accordingly. The adjustable range is limited within the screen.

### Disable the Cursor Measurement Function

When cursor measurement is enabled, you can disable it in the following ways:



- In the **Cursors** menu, click or tap the **Remove** button to disable cursor measurements.
- In the "Result" bar at the right side of the screen, click or tap the "Cursors" label and then click or tap **Remove** in the pop-up window.
- In the "Result" bar at the right side of the screen, drag the "Cursors" label to the right to simply disable cursor measurements.
- Press the front-panel  key to disable cursor measurements.

# 11 Digital Voltmeter (DVM) and Frequency Counter

This series oscilloscope provides a built-in digital voltmeter (DVM) and frequency counter, which enable you to perform more accurate measurements, improving user experience in counter and frequency measurement.

## 11.1 Digital Voltmeter (DVM)

The built-in DVM of this oscilloscope provides 4-digit voltage measurements on any analog channel. DVM measurements are asynchronous from the oscilloscope's acquisition system and are always acquiring. You can enable the DVM measurements in the following ways.

- Click or tap the function navigation icon  > **DVM** to enable DVM measurements.
- Click or tap the **DVM** button on the toolbar to enable DVM measurements.
- Press the front-panel  key and then select **DVM** in the displayed "Analyse" menu to enable the DVM measurements.

After the DVM measurements are enabled, the "DVM" label appears in the "Result" bar at the right section of the screen, as shown in the figure below.

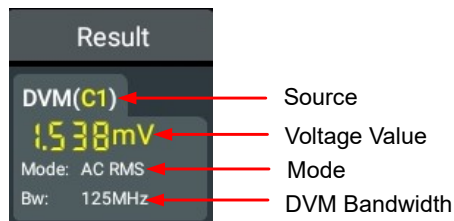

The voltage value in the label shows the current measurement value, and the bandwidth is the optimal signal input bandwidth.

Click or tap the "DVM" label and then a window is displayed. Click or tap **Setting** to enter the DVM setting menu. You can click or tap **Remove** to disable DVM measurements.

### 11.1.1 Measurement Settings

After the DVM is enabled, click or tap the "DVM" label in the "Result" bar at the right section of the screen and a window is displayed. Click or tap **Setting** in the window to enter the DVM setting menu, as shown in the figure below.

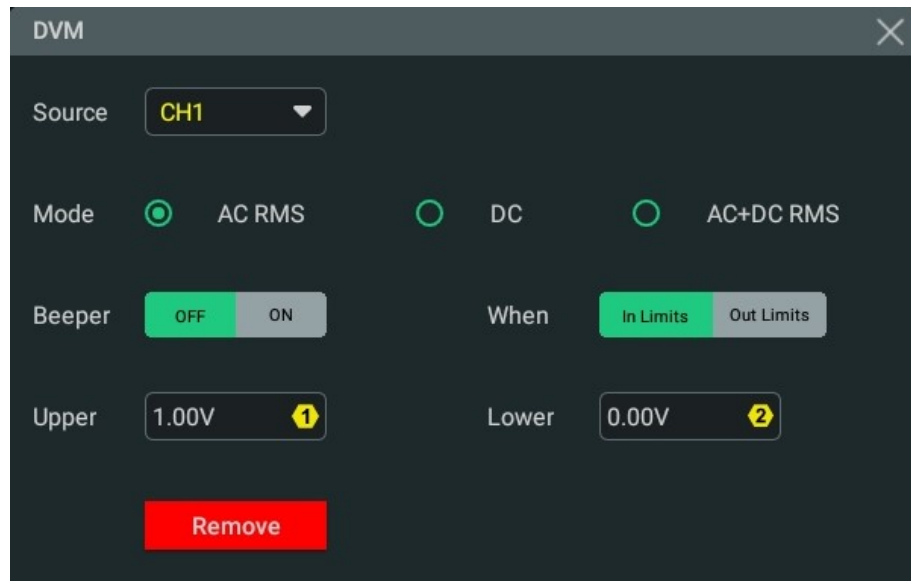

Figure 11.1 DVM Setting Menu

### Select the Measurement Source

Click or tap the **Source** drop-down button to select the desired source. The analog channel (CH1-CH4) can be selected to be the measurement source.

Even if the analog channel (CH1-CH4) is not enabled, you can still perform the DVM measurements.

### Select the Measurement Mode

In the **Mode** item, you can select the DVM mode. The DVM measurement modes include AC RMS, DC, and AC+DC RMS.

- AC RMS: displays the root-mean-square value of the acquired data, with the DC component removed.
- DC: displays the average value of the acquired data.
- AC+DC RMS: displays the root-mean-square value of the acquired data.

### Set the Limits

Click or tap the **Beeper** on/off switch to turn on or off the beeper. When the beeper is turned on, you can enable the beeper to sound an alarm when the voltage value is inside or outside the limited range.

- Limits Condition Setting

Click or tap the **When** toggle button to select "In Limits" or "Out Limits".

- In Limits: when the voltage value is inside the limited range, you can enable or disable the beeper to sound an alarm.

- Out Limits: when the voltage value is outside the limited range, you can enable or disable the beeper to sound an alarm.
- Upper/Lower Limit Setting

Click or tap the input field of **Upper**, then use the pop-up numeric keypad to set the upper limit of the voltage or use the corresponding multifunction knob to set the value.

Click or tap the input field of **Lower**, and then use the pop-up numeric keypad to set the lower limit of the voltage or use the corresponding multifunction knob to set the value.

The range of upper and lower limits is from -500 V to 500 V, and the lower limit value cannot be greater than the upper limit value.



### 11.1.2 Remove the Measurement

Click or tap the "DVM" label in the "Result" bar and a window is displayed. Click or tap **Remove** to disable DVM measurements and clear the measurement results. You can also click or tap **Remove** in the DVM setting menu to disable the function.

## 11.2 Frequency Counter

The frequency counter analysis function provides frequency, period, or edge event counter measurements on any analog channel.

You can enable the counter in the following ways:

- Click or tap  > **Counter** to enable the counter.
- Click or tap the **Counter** button on the toolbar to enable the counter.
- Press the front-panel  key and then select **Counter** in the displayed "Analyse" menu to enable the counter.

After the counter is enabled, the "Counter" label displaying the counter measurement results appears in the "Result" bar at the right section of the screen, as shown in the figure below. You can set the **Statistic** switch to "ON" in "Counter" menu to enable the statistical results. You can refer to *Statistics Results*.

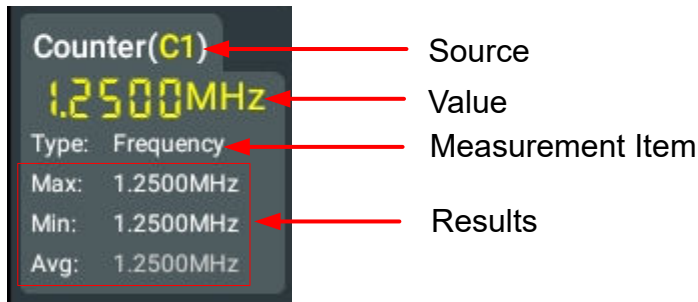

You can click or tap the "Counter" label in the "Result" bar and select **Reset Stat.**, **Setting**, or **Remove** in the displayed window.

## 11.2.1 Measurement Settings

After the frequency counter is enabled, click or tap the "Counter" label in the "Result" bar at the right section of the screen and a window is displayed. Click or tap **Setting** in the window to enter the counter setting menu, as shown in the figure below.

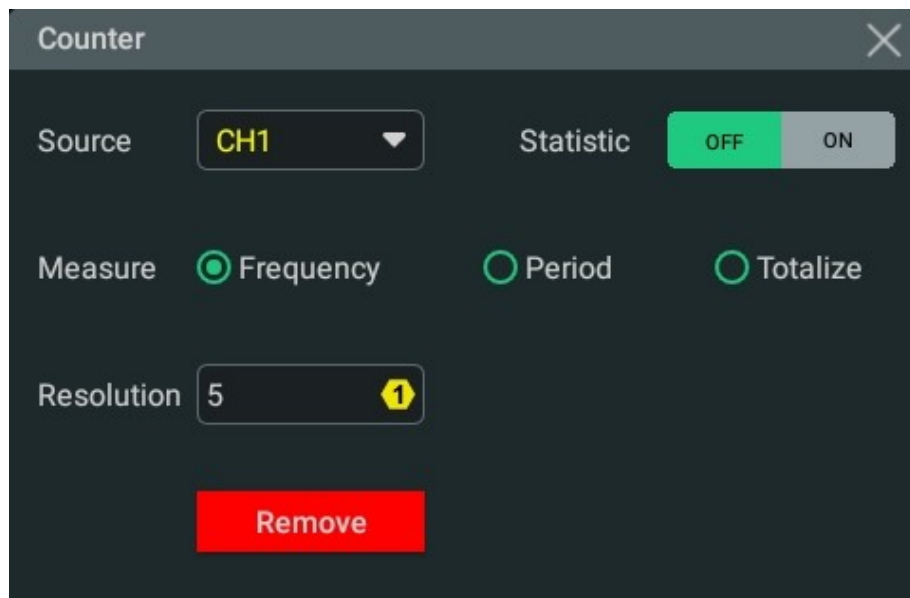

Figure 11.2 Frequency Counter Setting Menu

### Select the Measurement Source

Click or tap the drop-down button of **Source** to select the desired source. Analog channels (CH1-CH4) and digital Channels (D0-D15) can be selected as the source of the frequency counter.

### NOTE

Only when the digital channel probe is connected, can you select digital channels D0-D15 as the source.



### Set Resolution

For Period and Frequency measurements, you need to set the readout resolution. Click or tap the input field of **Resolution** to set the resolution by using the pop-up numeric keypad. You can also use the corresponding multifunction knob to set the value. The range of resolution is from 3 bits to 6 bits. By default, it is 4 bits.

The greater the resolution, the longer the gate time. In this way, the measurement time will be longer.

### Select the Measurement Item

In the **Measure** item, you can select the desired measurement item. Available options include Frequency, Period, and Totalize. Wherein, Totalize indicates the count of edge events on the signal.

### Clear Count

When "Totalize" is selected as the measurement item, the oscilloscope measures the count of edge events on the signal. At this time, click or tap **Clear Count** to clear the measurement results and start the measurements again.

### Statistics Results

When "Frequency" or "Period" is selected, click or tap the **Statistic** on/off switch to turn on/off displaying all statistical items. When enabled, all the statistical results will be displayed in the "Counter" label in the "Result" bar.

## 11.2.2 Reset Statistics

Click or tap the "Counter" label in the "Result" bar at the right section of the screen and a window is displayed. Click or tap **Reset Stat.** in the window to reset the statistics.

## 11.2.3 Remove the Measurement

Click or tap the "Counter" label in the "Result" bar at the right section of the screen and a window is displayed. Click or tap **Remove** to clear the measurement results. The "Counter" label disappears from the "Result" bar accordingly. You can also click or tap **Remove** in the counter setting menu to disable the function.

## 12 Digital Channel

This series oscilloscope provides a standard logic analyzer (LA) function with 16 digital channels. The default channel label is D0-D15. The oscilloscope compares the voltages acquired in each sample with the preset logic threshold. If the voltage of the sample point is above the threshold, it will be stored as logic 1; otherwise, it will be stored as logic 0. The oscilloscope displays the logic levels (1s and 0s) in a graphic way for you to easily detect and analyze the errors in circuit design (hardware design and software design).

You can enter the LA menu in the following ways.

- Press the front-panel  key to enter the menu.
- Click or tap the "LA" label at the bottom of the screen to enter the menu.

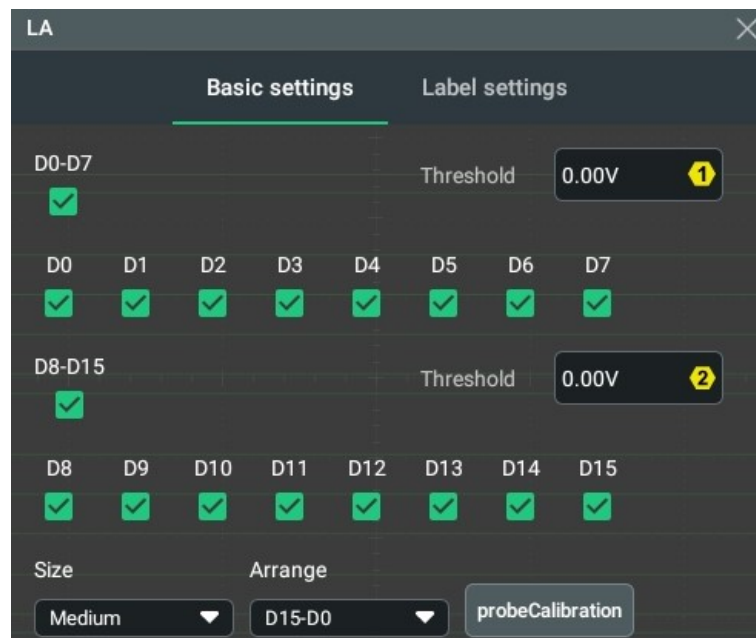

Figure 12.1 LA Menu

Before using the digital channels, connect the oscilloscope to the device under test (DUT) using the optional PLA2216 active logic probe. To cater to different application scenarios, PLA2216 provides two methods to connect the signal under test. For details, refer to *PLA2216 Active Logic Probe User Guide*.





### CAUTION

**The digital channel input terminal does not support hot plugging. Do not insert or pull out the logic probe when the instrument is powered on.**

## 12.1 To Enable or Disable the Digital Channel

Press the front-panel  key or click or tap the LA label at the bottom of the screen to enable/disable digital channels **D0-D15** at the same time.

In the menu as shown in *Figure 12.1*, click or tap the check box of any digital channel from **D0** to **D15** to enable/disable the specified channel. You can click or tap the check box of **D0-D7** to enable/disable all channels from D0 to D7. Similarly, click or tap the check box of **D8-D15** to enable/disable all channels from D8 to D15. The check box turns into  once the corresponding channel is enabled while the check box of disabled channel is .



### TIP

When you use **D0-D7** or **D8-D15** to enable or disable multiple channels simultaneously, you can still enable or disable any channel independently.

## 12.2 To Select the Digital Channel

After the digital channel is enabled, click or tap the label or waveform of the digital channel. Select any channel from D0 to D15. The waveform of the selected channel is in red.



### TIP

Only the enabled digital channel can be selected.

## 12.3 To Set the Threshold

The threshold levels of channels D0-D7 and channels D8-D15 can be set separately according to your needs. If the voltage of the input signal is above the threshold, it is treated as logic 1; otherwise, it is treated as logic 0.

- In the menu as shown in *Figure 12.1*, click or tap the **Threshold** input field at the right side of **D0-D7**, and then use the pop-up numeric keypad to set the threshold for D0-D7. You can also use the corresponding multifunction knob to set the value.
- In the menu as shown in *Figure 12.1*, click or tap the **Threshold** input field at the right side of **D8-D15**, and then use the pop-up numeric keypad to set the threshold for D8-D15. You can also use the corresponding multifunction knob to set the value.

## 12.4 To Set the Waveform Size

In the menu as shown in *Figure 12.1*, click or tap the **Size** drop-down button to select the waveform display size. Available options include "Small", "Medium", and "Large".



### TIP

"Large" is available only when the number of currently enabled channels is not greater than 8.

## 12.5 To Set the Order

In the menu as shown in *Figure 12.1*, click or tap the **Arrange** drop-down button to select the waveform arrangement order for the currently enabled channels on the display.

- D0-D15: the waveforms on the display are D0-D15 in sequence from top to bottom.
- D15-D0: the waveforms on the display are D15-D0 in sequence from top to bottom.

You can also drag the digital channel waveform in the waveform view to change the order.

## 12.6 Probe Calibration

If the PLA2216 active logic probe is connected to the oscilloscope for the first time or when the changes of the ambient temperature are above 5°C, it is recommended to perform zero calibration for the probe. Make sure that no signal is applied to the PLA2216 input terminal when the probe is under calibration.

In *Figure 12.1*, click or tap **ProbeCalibration** to enter the "ProbeCalibration" menu. Click or tap **Start** to start zero calibration automatically for the probe.

## 12.7 Label Settings

By default, the instrument takes D0-D15 as the channel label of the 16 digital channels. You can set a user-defined label for each digital channel to easily differentiate the digital channels.

In the LA menu, click or tap **Label settings** to enter the Label settings menu. You can then use the preset label or input a label manually.

### Label On/Off

Click or tap the **Label Enable** on/off switch to enable or disable the label display. If it is on, the channel label will be displayed at the left side of the waveform.

### Select a Specified Digital Channel

Click or tap the **ChanSelect** drop-down button to select a digital channel. You can select any channel from D0 to D15.

### Use Preset Labels

Click or tap the **Label library** drop-down button to select a preset label. Available preset labels include ACK, ADO, ADDR, BIT, CAS, CLK, CS, DATA, HALT, INT, LOAD, NMI, OUT, RAS, PIN, RDY, RST, RX, TX, WR, MISO, MOSI, and D0-D15.

### Input a Label Manually

Click or tap the **Edit** input field and use the pop-up virtual keypad to set the label. For the methods of using the virtual keypad, refer to *Parameter Setting Method*.

## 13 Histogram Analysis

The histogram analysis function can provide the statistic view for waveform and measurement results, enabling you to judge the trend of waveforms, and quickly locate the potential problems of the signal. This series oscilloscope supports histogram types including Horizontal, Vertical, and Measure.

Click or tap the function navigation icon  and select **Histogram** to enter the Histogram menu.

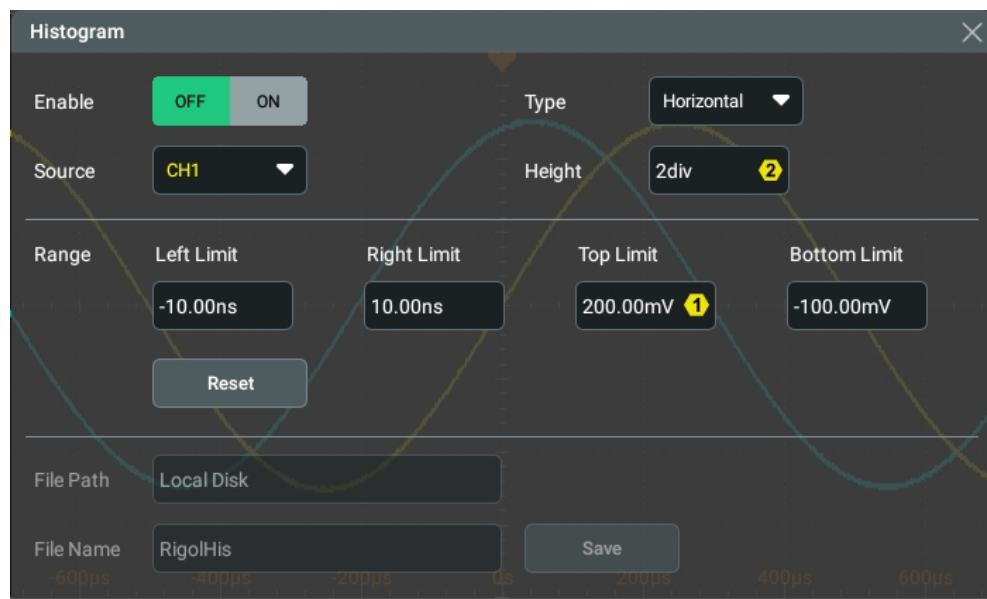

Figure 13.1 Histogram Menu

### 13.1 To Enable or Disable the Histogram Function

In Histogram menu, click or tap the **Enable** on/off switch to enable or disable the histogram analysis. After the histogram function is enabled, with the on-going acquisition and measurement of the waveforms, the height of the bar graph will change within the set range of the histogram window to indicate the number of times for data statistics.

Take horizontal histogram as an example. After the histogram function is enabled, the histogram analysis view as shown in the figure below is displayed on the screen. Also, the "Histogram" label appears on the **Result** bar at the right side of the screen.

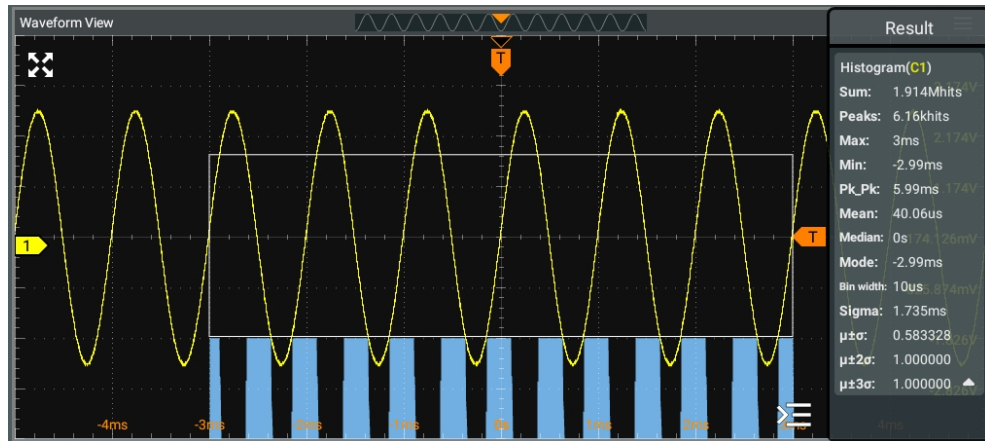

Figure 13.2 Histogram Analysis Interface

When the histogram function is enabled, you can click or tap the "Histogram" label > **Setting** to open the histogram setting menu.



#### TIP

For definitions of the measurement items in the "Histogram" label, refer to *Histogram Analysis Results*

## 13.2 To Select the Histogram Type

In the Histogram menu, click or tap the **Type** drop-down button to select the histogram type.

- Horizontal: displays the number of times for statistics making in the forms of columns in the histogram bar graph at the bottom of the graticule.
- Vertical: displays the number of times for statistics making in the forms of rows in the histogram bar graph at the left of the graticule.

## 13.3 To Select the Histogram Source

In the Histogram menu, Click or tap the **Source** drop-down button to select the desired source. The analog channels (CH1-CH4) can be selected to be the histogram source.

## 13.4 To Set the Histogram Height

The histogram height indicates the number of grids the histogram bar graph should use on the screen.

In Histogram menu, click or tap the input field of **Height**, and then use the pop-up numeric keypad to set the height. It ranges from 1 div to 4 div, and the default is 2 div.

## 13.5 To Set the Histogram Range

You need to set the histogram window range. Adjust the size and position of the histogram window by setting the "Left Limit", "Right Limit", "Top Limit", and "Bottom Limit" respectively.

- Click or tap the **Left Limit** input field and use the pop-up numeric keypad to set the value. You can also use the corresponding multifunction knob to set the value.
- Click or tap the **Right Limit** input field and use the pop-up numeric keypad to set the value. You can also use the corresponding multifunction knob to set the value.
- Click or tap the **Top Limit** input field and use the pop-up numeric keypad to set the value. You can also use the corresponding multifunction knob to set the value.
- Click or tap the **Bottom Limit** input field and use the pop-up numeric keypad to set the value. You can also use the corresponding multifunction knob to set the value.

### NOTE

Adjusting the horizontal time base or vertical scale will not affect the histogram limit range, but only shows variation with the scale.

### TIP

You can also drag the histogram window in white to adjust the window's size and position.

## 13.6 Histogram Analysis Results

After the histogram analysis function is enabled, the "Histogram" label will be displayed in the **Result** sidebar. The histogram measurement results include the following parameters.

- Sum: indicates the sum of all bins (buckets) in the histogram.

- Peaks: indicates the maximum number of hits in any single bin.
- Max: indicates the maximum value.
- Min: indicates the minimum value.
- Pk\_Pk: indicates the Delta (Max-Min) between the max. value and the min. value.
- Mean: indicates the average value of the histogram.
- Median: indicates the median value of the histogram.
- Mode: indicates the mode value of the histogram.
- Bin width: indicates the width of each bin (bucket) in the histogram.
- Sigma: indicates the standard deviation of the histogram.
- $\mu \pm \sigma$ : indicates the proportion of the number of frequencies or counts of the histogram hits that lie within one standard deviation of the mean to the total number of histogram hits.  $\mu$  indicates the mean value in normal distribution. It is the average of the numbers.  $\sigma$  indicates the standard deviation in the normal distribution.
- $\mu \pm 2\sigma$ : indicates the proportion of the number of frequencies or counts of the histogram hits that lie within two standard deviation of the mean to the total number of histogram hits.  $\mu$  indicates the mean value in normal distribution. It is the average of the numbers.  $\sigma$  indicates the standard deviation in the normal distribution.
- $\mu \pm 3\sigma$ : indicates the proportion of the number of frequencies or counts of the histogram hits that lie within three standard deviation of the mean to the total number of histogram hits.  $\mu$  indicates the mean value in normal distribution. It is the average of the numbers.  $\sigma$  indicates the standard deviation in the normal distribution.

## 13.7 To Export Histogram Data

Ensure that the histogram is enabled and displaying the required data. The histogram data can then be exported to an external storage device or computer for further data processing, statistical analysis, or report generation.

Click or tap the input field of **File Path**, and then the "Disk" interface is displayed. Select the desired destination path, and then click or tap **OK** to confirm the operation. For details about the disk management, refer to *Disk Management*.

Click or tap the input field of **File Name** to input the filename of histogram data file with the pop-up virtual keypad.

Click or tap **Save** to save the Histogram data file according to the settings.

## 13.8 To Remove Results

- Click or tap the "Histogram" label in the Result sidebar and a window is displayed. Click or tap **Remove** in the window to remove measurement results and disable the histogram function.

- In the "Result" bar at the right side of the screen, drag the "Histogram" label to the right to quickly remove results and disable the histogram function.

## 13.9 To Clear Statistics

Click or tap the "Histogram" label in the Result sidebar and a window is displayed. Click or tap **Clear** in the window to clear all statistical data and restart to make statistics. You can also click or tap **Reset** in the "Histogram" setting menu to reset the statistical data.

## 14 Function/Arbitrary Waveform Generator (Option)

MHO984, MHO954 and MHO934 provide the optional 2-CH 100 MHz or 50 MHz Function/Arbitrary Waveform Generator (AFG). The oscilloscope integrates the signal source and the oscilloscope into one, providing great convenience for engineers who need to use the signal source and oscilloscope at the same time. This chapter introduces how to use the AFG.

To enable the AFG function, perform any of the following operations:

- Press **G** on the front panel to open the AFG setting menu. Click or tap the **Output** switch to select "ON" to enable the AFG output of the specified channel.
- Click or tap the AFG label at the bottom of the screen to enter the specified AFG setting interface.

The on/off status of the specified AFG channel is indicated in its label color. When enabled, GI and GII labels are highlighted in orange and pink respectively, with output waveform information on it. When disabled, GI and GII are grayed out.

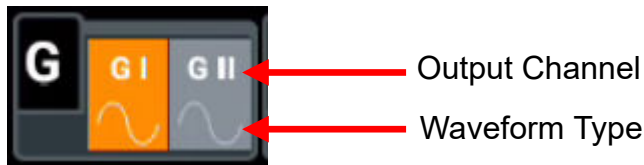

To disable the AFG function, you can click or tap the **Output** switch to select "OFF" to exit the specified AFG interface. Also, you can drag the label downward to disable the enabled AFG channel and exit the specified AFG interface.

### 14.1 To Output Basic Waveforms

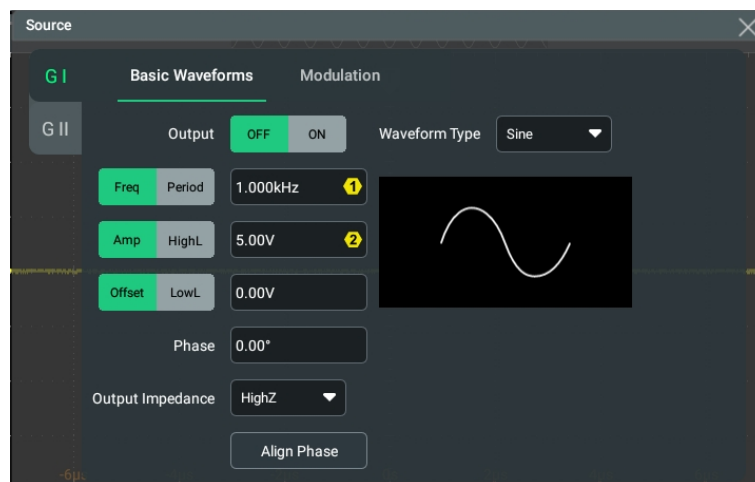

Figure 14.1 AFG Setting Menu

The Function/Arbitrary Waveform Generator can output a variety of waveforms, including standard waveforms (Sine, Square, Ramp, Noise), built-in waveforms (DC, Sinc, Exp. Rise, Exp. Fall, ECG1, Gauss, Lorentz, Haversine), and arbitrary waveforms.

You can set the basic waveform parameters according to the following section and then click or tap the **Output** switch to select ON to enable the output of the [GI] or [GII] on the rear panel.

### 14.1.1 Sine

In the AFG setting menu, click or tap the **Type** drop-down button to select "Sine". At this time, you can set the parameters for the sine waveform.

#### Set the Frequency

Click or tap the input field of **Freq/Period** to set the frequency or period of the current Sine signal with the pop-up numeric keypad. You can also use the specified knob indicated in the input field to set it. Different waveforms have different frequency or period (reciprocal of the frequency) ranges.

- Sine: 2 mHz to 100 MHz (AFG100), 20 mHz to 50 MHz (AFG50)
- Square: 2 mHz to 20 MHz (AFG100), 20 mHz to 10 MHz (AFG50)
- Built-in: 2 mHz to 20 MHz (AFG100), 20 mHz to 10 MHz (AFG50)
- Arb: 2 mHz to 20 MHz (AFG100), 20 mHz to 10 MHz (AFG50)
- Ramp: 2 mHz to 2 MHz (AFG100), 20 mHz to 1 MHz (AFG50)
- DC and Noise: no frequency parameter

#### Set the Amplitude

Click or tap the **Amp** input field to set the amplitude with the pop-up numeric keypad. You can also use the corresponding multifunction knob to set the value. The amplitude range of the Sine waveform is as follows:

- When the output frequency is less than or equal to 50 MHz:
  - 2 mVpp to 20 Vpp (HighZ)
  - 1 mVpp to 10 Vpp (Load)
- When the output frequency is greater than 50 MHz:
  - 2 mVpp to 10 Vpp (HighZ)
  - 1 mVpp to 5 Vpp (Load)

#### Set the Offset

Click or tap the **Offset** input field to set the offset with the pop-up numeric keypad. You can also use the corresponding multifunction knob to set the value.

- When the output frequency is less than or equal to 50 MHz:
  - 10 V to 10 V (HighZ)
  - 5 V to 5 V (Load)
- When the output frequency is greater than 50 MHz:
  - 5 V to 5 V (HighZ)
  - 2.5 V to 2.5 V (Load)

### Set the High/Low Level

In the amplitude and offset setting of the output waveform, you can also click or tap to select **HighL** or **LowL** to set the high level and low level of the output waveforms.

- Amplitude = (High Level- Low Level)
- Offset = (High Level+ Low Level)/2

The available range of high level and low level can be set as follows:

- When the output frequency is less than or equal to 50 MHz:
  - 10 V to 10 V (HighZ)
  - 5 V to 5 V (Load)
- When the output frequency is greater than 50 MHz:
  - 5 V to 5 V (HighZ)
  - 2.5 V to 2.5 V (Load)

The amplitude of "High Level- Low Level" must be within the available setting range. The default high level is 2.5 V. The default low level is -2.5 V.

### Set the Starting Phase

Click or tap the **Phase** input field to set the starting phase with the pop-up numeric keypad. You can also use the corresponding multifunction knob to set the value. The available range of start phase is from 0° to 360°. By default, it is 0°.

### Align Phase

Click or tap **Align Phase** to re-configure the two channels to output according to the set frequency and phase. If these two signals whose frequencies are identical or in multiple, you can click or tap this menu to align their phases.

Use the oscilloscope to acquire the waveforms of the two channels and stably display the waveforms. After switching the channel status, the phase deviation between the two waveforms is changed. At this time, click or tap **Align Phase**, then the phase deviation shown on the oscilloscope will restore to the current phase deviation between the two waveforms automatically.

### Output Impedance

The output impedance setting affects the output amplitude and DC offset. This instrument has a fixed series output impedance of 50  $\Omega$  to the rear-panel output connector. If the actual load impedance differs from the specified value, the voltage level displayed would not match the voltage level of the device under test. To ensure the correct voltage level, the load impedance setting must match the actual load.

Click or tap **Output Impedance** drop-down button to select "HighZ" or "Load".

#### Note

After modifying the impedance, the instrument will adjust the output amplitude and offset voltage automatically. For example, the current amplitude is 5 Vpp. At this point, change the output impedance from Load to HighZ and the amplitude displayed in the input field will be doubled to 10 Vpp. If the output impedance is changed from HighZ to Load, the amplitude will be reduced by half to 2.5 Vpp. Note that only the displayed values change with the parameter and the actual output from the generator does not change.

## 14.1.2 Square

In the AFG setting menu, click or tap the **Type** drop-down button to select "Square". At this time, you can set the parameters for the square waveform.

Refer to *Sine* to set the frequency, phase, amplitude, and offset parameters. This section will only elaborate on how to set the duty cycle.

#### Set the Duty Cycle

Square duty cycle is the percentage of time that the square wave is at a high level over the period of the square wave, as shown in the figure below. The parameter is valid only when the square wave is selected.

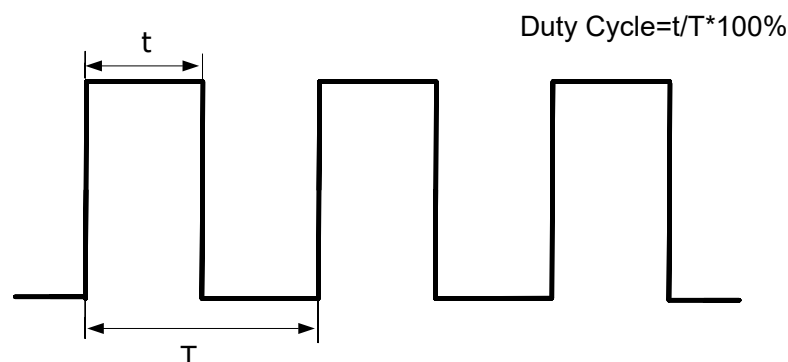

Click or tap the **Duty** input field to set the duty cycle with the pop-up numeric keypad. You can also use the corresponding multifunction knob to set the value. Its range is from 1% to 99%, and the default is 50%. The settable range for the maximum and minimum values is limited by the output frequency.

### 14.1.3 Ramp

In the AFG setting menu, click or tap the **Type** drop-down button to select "Ramp". At this time, you can set the parameters for the ramp waveforms.

Refer to Sine to set the frequency, phase, amplitude, and offset parameters. This section will only elaborate on how to set the symmetry.

#### Symmetry

Symmetry is defined as the percentage of the amount of time ramp wave is rising in the whole period, as shown in the figure below. The parameter is valid only when ramp is selected.

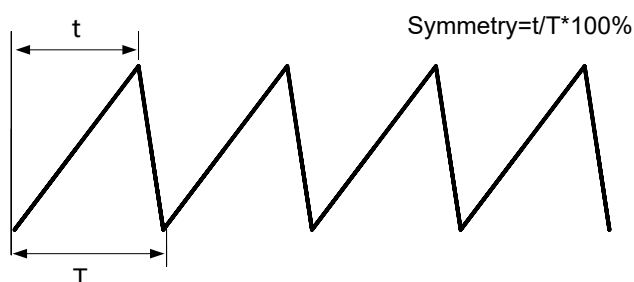

Click or tap the **Symm** input field to set the symmetry with the pop-up numeric keypad. You can also use the corresponding multifunction knob to set the value. The available range of symmetry is from 0% to 100%. By default, it is 50%.

### 14.1.4 Noise

In the AFG setting menu, click or tap the **Type** drop-down button to select "Noise". At this time, you can set the parameters for the Noise.

You can click or tap **Amp** to set the amplitude of Noise waveform. Its available range is from 2 mVpp to 10 Vpp when the output impedance is set to HighZ and 1 mVpp to 5 Vpp when the output impedance is set to Load. Click or tap **Offset** to set the offset of the Noise waveform. The range of the offset is related to its amplitude value.

You can also click or tap to switch to the **HighL** and **LowL** tab to set the high level and low level of the Noise waveform. For details, refer to descriptions in Sine.

### 14.1.5 DC

In the Basic Waveforms tab, click or tap the drop-down button of **Type** to select "DC". Then you can set the DC parameters.

Click or tap the **Offset** input field to set the offset with the pop-up numeric keypad. You can also use the corresponding multifunction knob to set the value. The available range of offset is from -10 V to 10 V when the output impedance is set to HighZ and from -5 V to 5 V when the output impedance is set to Load.

### 14.1.6 Exp.Rise

The Exp.Rise waveform is as shown in the figure below.

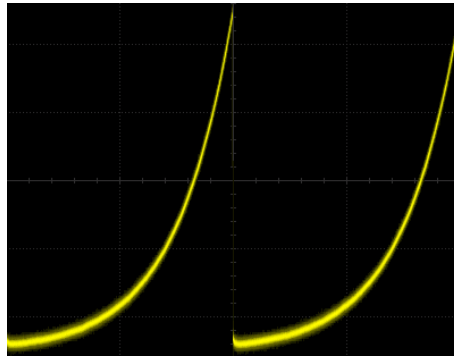

Figure 14.2 Exp.Rise

In the Basic Waveforms tab, click or tap the drop-down button of **Type** to select "Exp.Rise". Then set the Exp.Rise parameters. For setting methods, refer to descriptions in Sine.

### 14.1.7 Exp.Fall

The Exp.Fall waveform is as shown in the figure below.

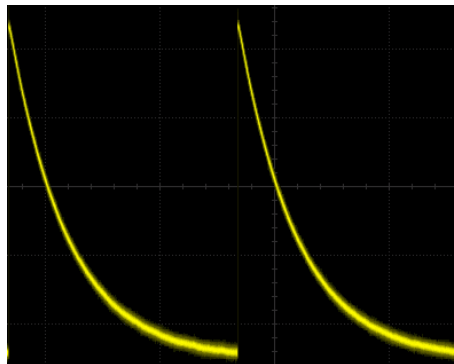

Figure 14.3 Exp.Fall

In the AFG setting menu, click or tap the **Type** drop-down button to select "Exp.Fall". For setting methods, refer to descriptions in Sine.

### 14.1.8 ECG1

The ECG1 waveform is as shown in the figure below.

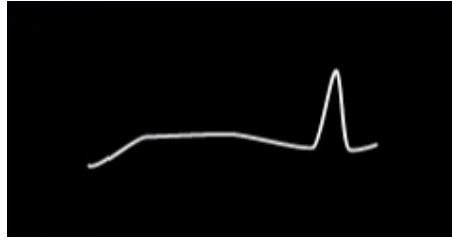

Figure 14.4 ECG1

In the AFG setting menu, click or tap the **Type** drop-down button to select "ECG1". For setting methods, refer to descriptions in Sine.

### 14.1.9 Gauss

The Gauss waveform is as shown in the figure below.

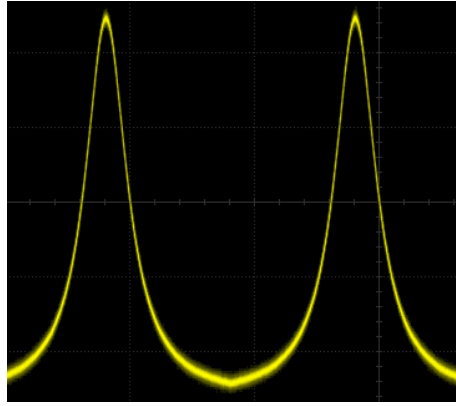

Figure 14.5 Gauss

In the Basic Waveforms tab, click or tap the drop-down button of **Type** to select "Gauss". Then set the Gauss parameters. For detailed setting methods, refer to descriptions in Sine.

### 14.1.10 Lorentz

The Lorentz waveform is as shown in the figure below.



**Figure 14.6 Lorentz**

In the Basic Waveforms tab, click or tap the drop-down button of **Type** to select "Lorentz". Then set the Lorentz parameters. For detailed setting methods, refer to descriptions in Sine.

### 14.1.11 Haversine

The Haversine waveform is as shown in the figure below.

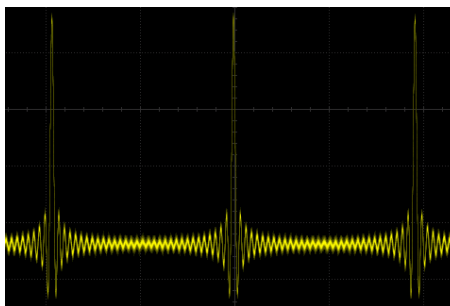

**Figure 14.7 Haversine**

In the Basic Waveforms tab, click or tap the drop-down button of **Type** to select "Haversine". Then set the Haversine parameters. For detailed setting methods, refer to descriptions in Sine.

### 14.1.12 Sinc

The Sinc waveform is as shown in the figure below.



**Figure 14.8 Sinc**

In the Basic Waveforms tab, click or tap the drop-down button of **Type** to select "Sinc". Then set the Sinc parameters. For setting methods, refer to descriptions in Sine.

### 14.1.13 Arbitrary Waveform

In the AFG setting menu as shown in *Figure 14.1*, click or tap the **Type** drop-down button to select "Arb". At this time, you can load the arbitrary waveform and set the parameters. After the file is loaded, modifying parameters such as the frequency, amplitude, offset, and phase only changes the waveform output. It does not affect the Arb file content. For how to set parameters such as frequency, phase, amplitude, and offset, refer to descriptions in Sine. This section only illustrates how to load the arbitrary waveform.



#### TIP

Before the arbitrary waveform file is successfully loaded, the AFG will continue to output the previous waveform type.

Click or tap the input field of **Arb Path**, and then the disk management interface is displayed. In the disk management interface, select an Arb file (\*.csv) from the internal/external memory and then click or tap **OK** to confirm the selection. After that, click or tap **Load** in the AFG setting menu. You can load a specified Arb waveform if the file format is correct. For details about disk management, refer to *Disk Management*.



#### NOTE

The current version only supports loading Arb files in \*.csv format, as shown in the figure below.

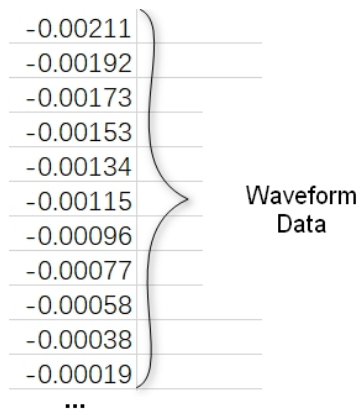

- For the current version, you can only import a fixed number of 16384 points. Some other operations such as point editing and block editing are not supported. Each data point supports a maximum of 6 effective number of digits and the excess will be truncated.
- You will fail to load the file if the waveform points in the file does not conform to the restrictions. This instrument's AFG does not support loading arbitrary waveform files that contain a file header. It is recommended to use Ultra Station version 00.02.01.00.01 or higher to generate arbitrary waveforms, and uncheck the "Save file header" option when saving. The Ultra Station software installation package and help document are available on the official website.

## 14.2 Modulation

Modulation is a process of converting analog or digital signals into high-frequency signals that are suitable for transmission. We called the original signal as the modulating waveform; the high-frequency signal used to carry the modulating signal is called the carrier waveform.

The AFG function supports AM, FM, and PM modulation types. The modulating signal is the built-in waveform of AFG; the carrier waveform signal is the basic waveform output by the AFG.

In the AFG setting menu, click or tap the **Modulation** tab to enter the Modulation setting menu.

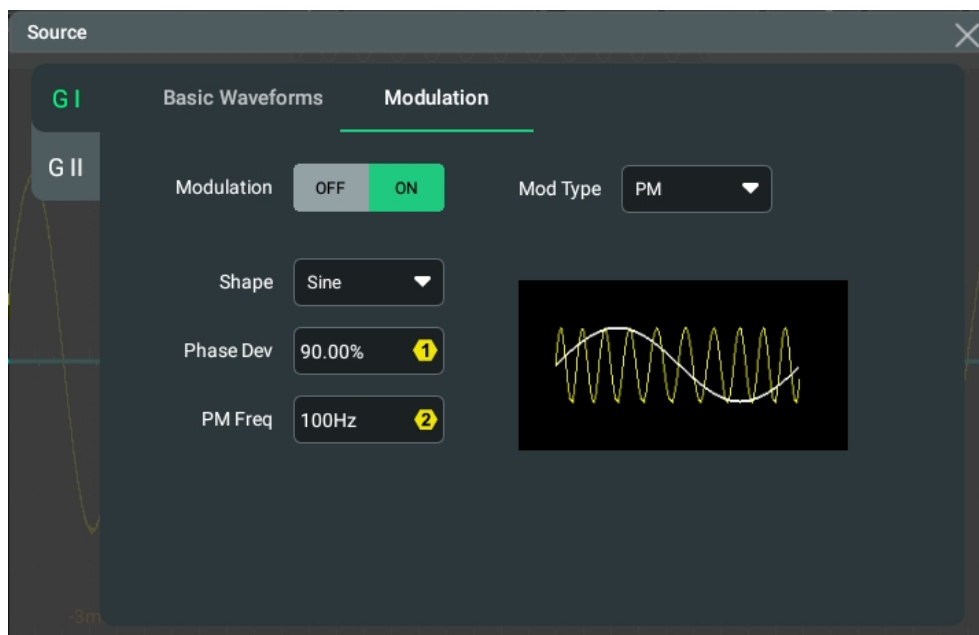

Figure 14.9 Modulation Interface

Please configure the modulation settings according to the following procedures.

1. In the **Basic Waveforms** tab, click or tap ON to enable the output for the specified channel.
2. Click or tap the drop-down button of **Waveform Type** to select the desired waveform type. Then configure the parameter settings for the selected waveform type. For details of the parameter configurations, refer to *To Output Basic Waveforms*. Supported carrier types include sine, square, and ramp. When the selected carrier waveform is not supported, the modulation function is not available.
3. Set the **Modulation** to "ON". The modulated signal can be output from the specified rear-panel AFG channel (G I or G II).
4. Click or tap the drop-down button of **Mod Type** to select the desired modulation type. Then configure the parameter settings for the selected modulation type.

The following section introduces the three modulation types.

### 14.2.1 AM

Amplitude Modulation (AM), namely the amplitude of the carrier waveform changes with the variation of the modulating waveform as shown in the following figure.

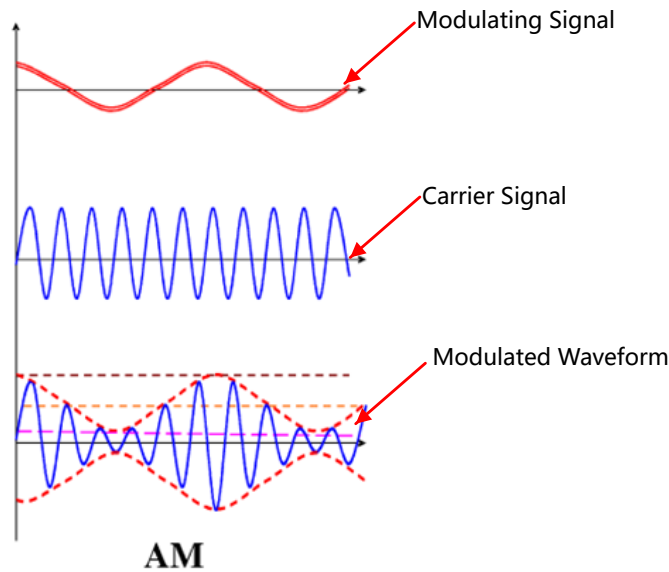

Figure 14.10 AM

### Select the Modulation Type

Click or tap the **Mod Type** drop-down button to select "AM" to enter the AM setting menu.

### Select the Modulating Waveform

The instrument uses built-in signals for modulation. Click or tap the **Shape** drop-down button to select the modulating waveform. Available waveform types include:

- Sine
- Square with 50% duty cycle
- Triangle with 50% symmetry
- UpRamp with 100% symmetry
- DnRamp with 0% symmetry
- White gaussian noise

### Set the Modulation Depth

Modulation depth is a percentage that represents the amplitude variation. Click or tap the **AM Depth** input field to set the modulation depth with the pop-up numeric keypad. You can also use the corresponding multifunction knob to set the value. AM depth ranges from 0% to 120%, and the default is 100%.

- At 0% depth, the amplitude is one-half of the carrier's amplitude setting.
- At 100% depth, the amplitude is identical to the carrier's amplitude setting.
- At greater than 100% depth, the instrument will not exceed the currently allowed maximum output amplitude.

### Set the Modulation Frequency

When the selected modulating waveform is not noise, you can set the modulation frequency. Click or tap the **AM Freq** input field to set the modulation frequency with the pop-up numeric keypad. You can also use the corresponding multifunction knob to set the value. The available range of the AM frequency is from 2 mHz to 1 MHz.

### Enable the Modulation Output

Click or tap ON for **Modulation** to enable the modulation function. In the Basic Waveforms interface, click or tap ON for **Output** to enable the waveform output. Then the modulated waveforms will be output from the specified AFG terminal based on the settings.

## 14.2.2 FM

Frequency Modulation (FM), namely the frequency of the carrier waveform changes with the voltage of the modulating waveform.

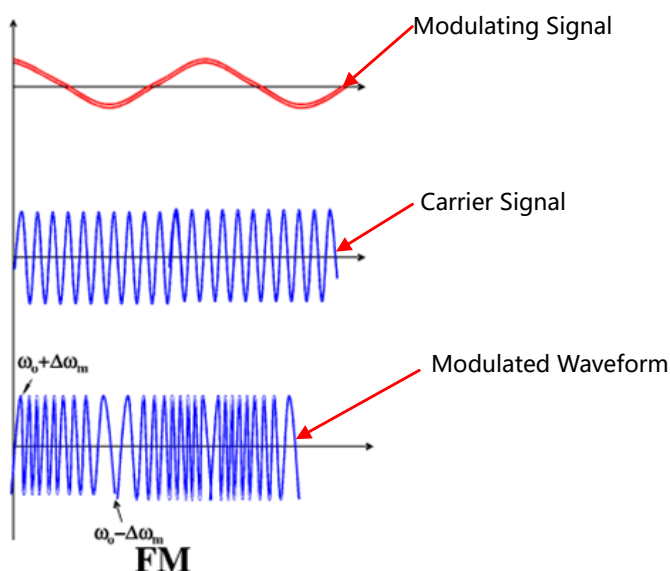

Figure 14.11 FM

### Select the Modulation Type

Click or tap the **Mod Type** drop-down button to select "FM".

### Select the Modulating Waveform

The instrument uses the built-in signal to perform waveform modulation. Click or tap the drop-down button of **Shape** to select the modulating waveform. The available waveform types include:

- Sine

- Square with 50% duty cycle
- Triangle with 50% symmetry
- UpRamp with 100% symmetry
- DnRamp with 0% symmetry
- Noise - white gaussian noise

### Set the Frequency Deviation

Frequency deviation represents the peak variation in frequency of the modulated waveform from the carrier frequency. Click or tap the **Deviation** input field to set the frequency deviation with the pop-up numeric keypad. You can also use the corresponding multifunction knob to set the value. Its range is from 2 mHz to the current carrier frequency.

#### TIP

The frequency deviation plus the carrier frequency must be less than or equal to the selected carrier's maximum frequency.

### Set the Modulation Frequency

When the selected modulating waveform is not noise, you can set the modulation frequency. Click or tap the **FM Freq** input field to set the modulation frequency with the pop-up numeric keypad. You can also use the corresponding multifunction knob to set the value. Its range is from 2 mHz to 1 MHz.

### Enable the Modulation Output

Click or tap ON for **Modulation** to enable the modulation function. In the Basic Waveforms interface, click or tap ON for **Output** to enable the waveform output. Then the modulated waveforms will be output from the specified AFG terminal based on the settings.

## 14.2.3 PM

Phase Modulation (PM), namely the phase of the carrier waveform changes with the voltage of the modulating waveform.

### Select the Modulation Type

Click or tap the **Mod Type** drop-down button to select "PM".

### Select the Modulating Waveform

The instrument uses the built-in signal to perform waveform modulation. Click or tap the drop-down button of **Shape** to select the modulating waveform. The available waveform types include:

- Sine
- Square with 50% duty cycle
- Triangle with 50% symmetry
- UpRamp with 100% symmetry
- DnRamp with 0% symmetry
- Noise - white gaussian noise

### Set the Phase Deviation

Phase deviation represents the peak variation in phase of the modulated waveform from the carrier waveform. Click or tap the **Phase Dev** input field to set the phase deviation with the pop-up numeric keypad. You can also use the corresponding multifunction knob to set the value. Its available range is from 0° to 360°, and the default is 90°.

### Set the Modulation Frequency

When the selected modulating waveform is not noise, you can set the modulation frequency. Click or tap the **PM Freq** input field to set the modulation frequency with the pop-up numeric keypad. You can also use the corresponding multifunction knob to set the value. Its range is from 2 mHz to 1 MHz.

### Enable the Modulation Output

Click or tap ON for **Modulation** to enable the modulation function. In the Basic Waveforms interface, click or tap ON for **Output** to enable the waveform output. Then the modulated waveforms will be output from the specified AFG terminal based on the settings.

## 15 Bode Plot (Option)

Bode plot is a way of graphically displaying the frequency response of a system. In the switch power supply and operational amplifier's circuit feedback network, the Bode plot provides the curves displaying the variation of gain and phase with the frequency for a loop analysis. The analysis on the system's gain and phase margins enables you to test the stability of the system.

With the signal generator module, the digital oscilloscope generates the sweep signal of a specified frequency range and outputs to the switching power supply circuit under test. Then, the oscilloscope draws a Bode plot displaying the variation of phase and gain with different frequencies.

Bode plot function can be enabled after the AFG option is installed. Click or tap the function navigation icon , and then select **Bode Plots** to enter the Bode Plot setting menu.

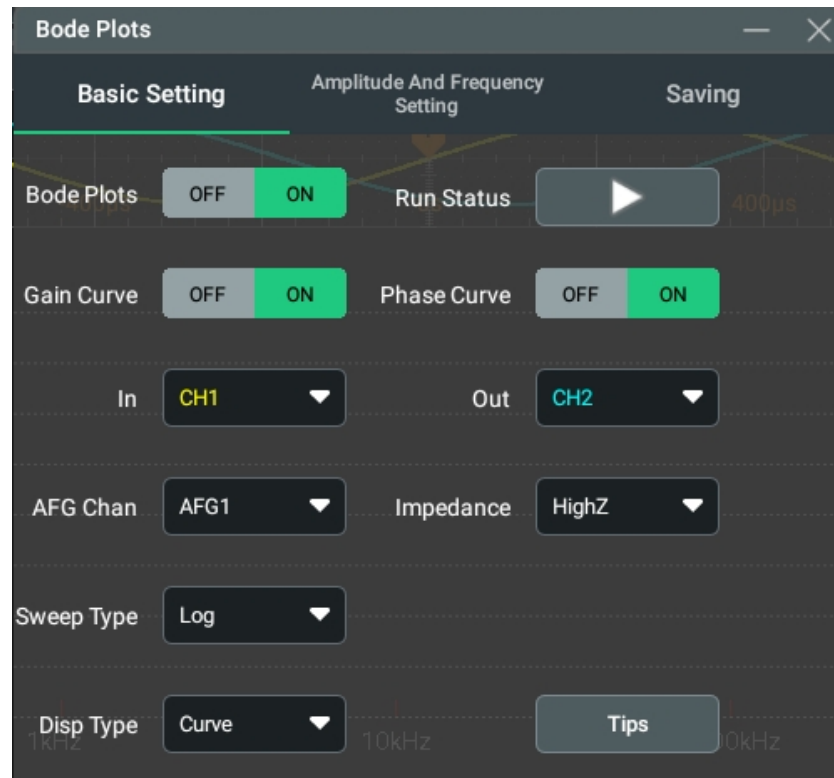

Figure 15.1 Bode Plot Setting Menu

Click or tap  to minimize the Bode Plot window.

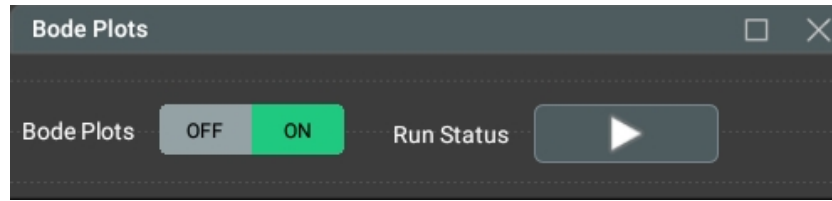

Figure 15.2 Minimized Bode Plot Window



#### NOTE

The Bode plot function can only test the response of basic devices such as amplifiers, but cannot test circuits with greater noise.



## 15.1 Basic Setting

Click or tap the **Basic Setting** tab to enter the basic setting menu. In this menu, you can enable or disable the Bode plot function, start or stop the Bode plot operation, set the gain/phase curve, set the input/output source, set the sweep type and display type, and check the connection diagram.

### 15.1.1 To Enable or Disable the Bode Plot Function

In the "Bode Plots" setting menu, click or tap the **Bode Plots** on/off switch to enable or disable the Bode function. After the Bode function is enabled, the Bode plot window will be displayed on the screen. For the bode plot display interface, refer to *To Set the Display Type*.

### 15.1.2 To Start or Stop the Operation

After the Bode function is enabled, in the setting menu, click or tap the  button of **Run Status** to launch or stop the loop analysis test and bode plot drawing operation. The oscilloscope will perform a test on the loop based on the current bode setting and draw the Bode plot. In running status, the button of **Run Status** is displayed as . After the Bode plot drawing is finished, the **Run Status** button restores to .

During the Bode plot drawing process, if you want to stop the drawing, you can click or tap .



#### NOTE

Enabling the bode plot test automatically disables the bode plot setting menu. You can click or tap  at the upper-right side to open the setting menu.

### 15.1.3 To Set the Input/ Output Source

---

- **Input Source:**

The input source indicates the channel input with the reference signal. The current frequency takes the frequency of this channel as the reference. The analog channel can be selected as the input source. The default input channel is CH1. Before selecting the input source, connect the signal under test to the analog channel input terminal of the oscilloscope.

- **Output Source:**

The output source indicates the channel that connects the feedback output signal. The analog channel can be selected as the output source. The default output channel is CH2. Before selecting the output source, connect the signal under test to the analog channel input terminal of the oscilloscope.

The analog channels are available for the input and output sources. For available analog channels for different models, refer to [Document Overview](#).

### 15.1.4 To Set the Sweep Signal

---

#### Sweep Source

Select the AFG channels from the drop-down list of **AFG Chan** as the channel source to output the sweep signal. The default channel is AFG1.

#### Sweep Type

Click or tap the drop-down button of **Sweep Type** to select "Log" or "Line".

- **Line:** the frequency of the swept sine wave varies linearly with the time.
- **Log:** the frequency of the swept sine wave varies logarithmically with the time.

### 15.1.5 To Set the Display Type

---

Click or tap the drop-down button of **Disp Type** to select "Curve" or "Chart".

#### Waveform Display

The Bode plot waveform display is as shown in the figure below. The X-axis in the Bode plot represents the frequency and the Y-axis represents the gain or phase. The magnitude-frequency curve (indicated in red) represents the gain between system input and output. The phase-frequency curve (indicated in green) represents the phase deviation between system input and output.

When the **Run Status** is stopped, you can select to display or hide the magnitude-frequency curve or phase-frequency curve.

Click or tap the **Gain Curve** switch to select "ON" to display or "OFF" to hide the magnitude-frequency curve.

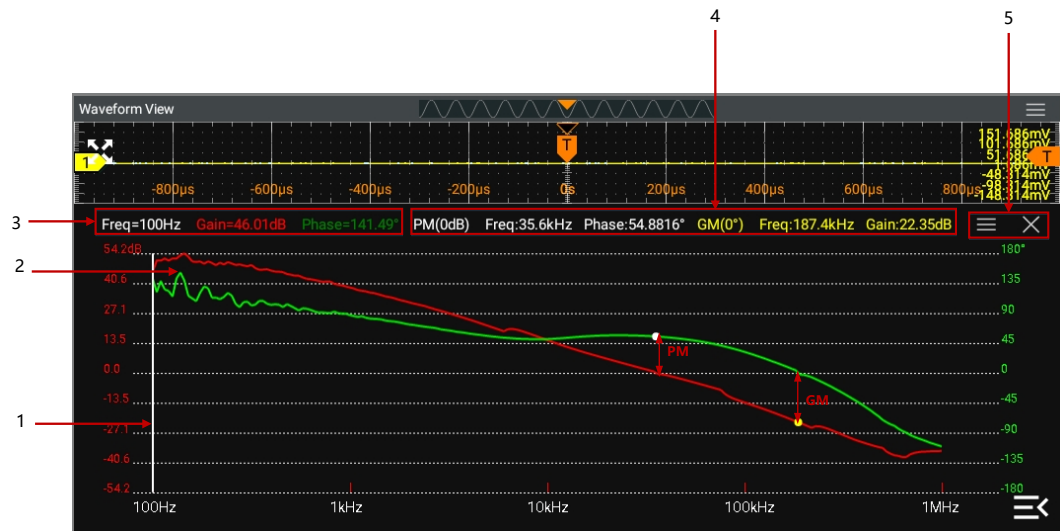

Click or tap the **Phase Curve** switch to select "ON" to display or "OFF" to hide the phase-frequency curve.





**Figure 15.3 Bode Plot Displayed in Waveform Display Form**

1. Cursor: rotate the multifunction knob 1 to move the cursor. The cursor information is display at the upper-right corner of the display.
2. Bode plot curves: magnitude-frequency curve (red) and phase-frequency curve (green).
3. Cursor information display:
  - Freq: indicates the X-axis value where the cursor is located in the Bode plot.
  - Gain: indicates the Y-axis value of the crossing point between the cursor and the red magnitude-frequency curve.
  - Phase: indicates the Y-axis value of the crossing point between the cursor and the green phase-frequency curve.

The cursor appears as a white vertical line in the Bode plot waveform display. You can rotate the specified multifunction knob to adjust the cursor position and view information about each point.
4. Margin result (displayed when the Bode plot operation stops):
  - PM: phase margin. It is the difference in phase between the phase at 0 dB gain frequency point and 0-degree phase.
  - GM: gain margin. It is the gain measurement difference between the value at 0 dB and the frequency point at 0-degree phase. That is,  $GM = 0 \text{ dB} - \text{Gain Measurement Value}$ .

5. Operation button: click or tap  to open the bode plot setting menu. Click or tap  to disable the bode plot waveform display and disable the Bode function.

### Chart Display

The Bode plot chart display is as shown in the figure below. It shows the frequency, gain, and phase of all sample points. Click or tap  to open the bode plot setting menu. Click or tap  to close the Bode plot chart and disable the Bode function.

Bode Plots 			
Index	Freq	Gain	Phase
1	100Hz	46.01dB	141.49°
2	104.71Hz	50.94dB	121.58°
3	109.64Hz	50.87dB	138.47°
4	114.81Hz	51.82dB	125.73°
5	120.22Hz	50.94dB	123.49°
6	125.89Hz	51.84dB	115.11°
7	131.82Hz	51.86dB	142.42°
8	138.03Hz	53.30dB	151.31°
9	144.54Hz	54.17dB	138.89°
10	151.35Hz	52.65dB	116.09°
11	158.48Hz	50.48dB	112.20°
12	165.95Hz	50.29dB	108.05°
13	173.78Hz	50.52dB	120.84°

Figure 15.4 Bode Plot Chart Display

## 15.1.6 To View the Connection Diagram

Before enabling the Bode plot function, make a proper loop connection. Click or tap **Connection Diagram** to view the loop connection diagram. According to the connection diagram, connect the rear-panel [GI] and [GII] output interface of the oscilloscope to the isolation transformer. Inject the output signal of the isolation transformer to the ends of the injection resistor of the circuit under test. Then measure the signals at the input terminal and the output terminal.

## 15.2 Cursors

The cursor appears as a white vertical line in the Bode graph interface, as shown in *Figure 15.3*. Its X-axis value (Freq), Y-axis value of the crossover point between the cursor and the magnitude-frequency curve (Gain), Y-axis value of the crossover point between the cursor and the phase-frequency curve (Phase) are displayed at the upper-left corner of the interface. You can rotate the multifunction knob 1 to adjust the cursor position to view the information of each point.

## 15.3 Amplitude And Frequency Setting

Click or tap the **Amplitude And Frequency Setting** tab to enter the Amplitude And Frequency Setting menu. Set the relevant parameters.

- **Start Frequency:** click or tap the **Start Freq** input field to set the start frequency of the sine wave with the pop-up keypad. You can also use the multifunction knob to set the value. The setting range is from 10 Hz to 3 MHz. By default, it is 100 Hz.  $\text{Start Frequency} \leq \text{Stop Frequency}/10$ .
- **Stop Frequency:** click or tap the **Stop Freq** input field to set the stop frequency of the sine wave with the pop-up keypad. You can also use the multifunction knob to set the value. The setting range is from 100 Hz to 30 MHz.  $\text{Start Frequency} \leq \text{Stop Frequency}/10$ .
- **Points/decade:** click or tap the **Points** input field to set the number of displayed points per decade. You can also use the multifunction knob to set the value. The setting range is from 10 to 100. By default, it is 10.
- **Amplitude:** click or tap the input field of **Amp** to set the voltage amplitude of the Sine wave when the **Var.Amp.** is set to "OFF".
- **Variable Amplitude:** click or tap the **Var.Amp.** on/off switch to turn on or off the variable amplitude function. When it is on, you can set the voltage amplitude of sine wave in different frequency ranges.

### TIP

The "Stop Freq" must be greater than the "Start Freq".



## 15.4 To Save and Load the Bode Plot File

Click or tap the **Saving** tab to enter the save setting interface. Here you can save and load the Bode plot data.

### Save the Test Data

1. Click or tap the drop-down button of **Format** to select the format of the saved Bode plot. The available file types include "\*.csv" and "\*.html".
2. Click or tap the input field of **File Name** to input the filename with the pop-up virtual keypad.
3. Click or tap the **File Path** input field and the "Disk" menu is displayed. Select the desired target path and then click or tap **OK** to set the path. For details about the Disk menu, refer to *Disk Management*.
4. Click or tap **save** to save the Bode plot file according to the settings.

### Load the Test Data



1. Click or tap the drop-down button of **File Type** to select "\*.csv" as the format of the file to be loaded.
2. Click or tap the **File Path** input field and the "Disk" menu is displayed. Select the desired target file and then click or tap **OK** to select the file. For details about the Disk menu, refer to *Disk Management*.
3. Click or tap **Load** to load the file. The saved test data will be displayed on the screen in a wave/chart format (depending on the display type setting).

## 16 Reference Waveform

This series oscilloscope provides 10 reference waveform positions (Ref1-Ref10). In the actual test process, you can compare the signal waveform with the reference waveform to locate the failure.

### 16.1 To Enable Ref Function

You can access the **Ref** menu in the following ways.

- Click or tap the function navigation icon  at the lower-left corner of the screen, and then select **Ref** to enter the reference waveform function menu.
- Press the front-panel  key to enter the reference waveform function menu.

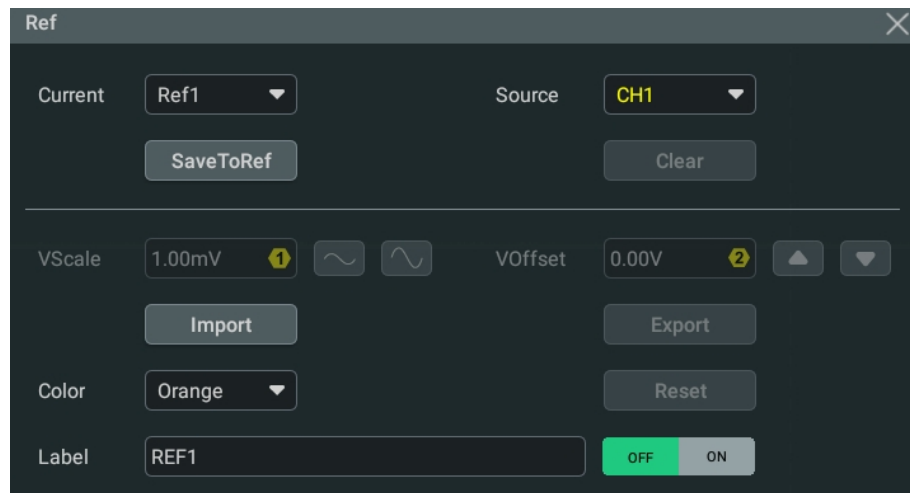

Figure 16.1 Reference Waveform Menu

When the Ref function is enabled, you can select different colors for reference waveforms, set the source of each reference channel, adjust the vertical scale and offset of the reference waveform, save the reference waveform to the internal or external memory, and recall it when necessary.

### 16.2 To Set the Reference Waveform

In the **Ref** menu, you can specify a channel to serve as the reference channel. You can save or clear the reference channel.

#### Select the Reference Channel

Click or tap the drop-down button of **Current** to select the reference waveform channel (Ref1-Ref10). By default, Ref1 is enabled.

### Select the Ref Source

Click or tap the drop-down button of **Source** to select the desired reference waveform source (CH1-CH4, D0-D15, or Math1-Math4).

### Save the Reference Waveform to Internal Memory

Click or tap **SaveToRef** to save the displayed waveform for the specified source to the internal memory as the reference waveform.



#### CAUTION

**This operation only saves the reference waveform to the volatile memory, and the waveform will be cleared at power-off or restored to the default settings. If you want to store reference waveforms that can be recalled when necessary, please export the waveform to internal or external memory (*Export to Internal or External Memory*)**

### Clear the Specified Reference Waveform

Click or tap **Clear** to clear the specified reference waveform for the "current channel".

You can also click or tap the **Clear** button in the function navigation menu or press

the front-panel  key to clear the reference waveforms of all the reference channels.

## 16.3 To Set the Ref Waveform Display

After clicking or tapping **SaveToRef**, you can adjust the vertical scale and offset of the reference waveform specified in **Current**.

### Modify the Vertical Scale

Click or tap the input field of **VScale**, and then use the pop-up numeric keypad to set the vertical scale of the reference waveform. You can directly click or tap the icons



at the right side of the input field of **VScale** to increase or decrease the vertical scale value. You can also use the corresponding knob to adjust the scale.

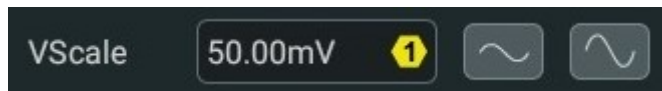

### Modify the Vertical Offset

Click or tap the input field of **VOffset**, and then use the pop-up numeric keypad to set the vertical offset of the reference waveform. You can directly click or tap the Up

and Down arrow icons  at the right side of the input field of **VOffset** to increase or decrease the vertical offset value. You can also use the corresponding knob to adjust the offset.



### Restore the Reference Waveform

If you have adjusted the vertical scale and offset for the specified reference waveform of the current channel, to reset the reference waveform to the position where the source channel stays prior to the **SaveToRef** operation, click or tap **Reset**.

### Set the Reference Waveform Color

This series oscilloscope provides five colors (gray, green, light blue, red, and orange) to mark the reference waveforms of different channels in order to distinguish them.

Click or tap the drop-down button of **Color** to select the color of the reference waveform of the channel.

### Set the Reference Waveform Label

Click or tap the **Label** on/off switch to enable or disable the label display of the specified reference waveform.

Click or tap the input field of **Label** to set the label of the specified reference channel with the pop-up numeric keypad.

## 16.4 To Export and Import the Reference Waveform

### Export to Internal or External Memory

You can save the current reference waveform to the internal memory or external USB storage device. The file format of the reference waveform is "\*.ref", "\*.bin", or "\*.csv".

Click or tap **Export** to enter the reference waveform file saving interface.

- **Set the Format**

In the file saving interface, click or tap the drop-down button of **Format** to select "\*.ref", "\*.bin", or "\*.csv" as the saving format.

- **Set the Filename**

Click or tap the input field of **File Name** to set the filename with the pop-up virtual keypad.

For how to use the keypad, refer to descriptions in *Parameter Setting Method*.

- **Set the Save Path**

Click or tap the **File Path** input field, then the disk management menu is displayed. Through the disk management menu, you can save the current reference waveform to the internal memory or external USB storage device. Then click or tap **Save** to complete the save operation. For details about the disk

management operation, refer to the *Disk Management* section in *Store and Load*.

**TIP**

- Only when the reference waveform is saved, can this export function be valid.
- For the ".bin" format file, refer to *Binary Data Format (.bin)*.

**Import from Internal or External Memory**

You can import the stored reference waveform file from the internal memory or external USB storage device to the instrument and display the file on the screen.

Click or tap **Import** to enter the reference waveform file loading interface.

- **Set the Format**

The file format of the reference waveform is specified as "\*.ref" which is displayed in **Format**.



- **Set the Load Path**

Click or tap the input field of **File Path**, then the disk management interface is displayed.

Through the disk management menu, you can load the current reference waveform to the waveform view of the oscilloscope. Then click or tap **Load** to complete the load operation. For details about the disk management operation, refer to the *Disk Management* section in *Store and Load*.

## 17 Pass/Fail Test

During the product design and manufacturing process, you usually need to monitor the variations of the signal or judge whether the product is up to standard. The pass/fail test function of this series oscilloscope can accomplish this task perfectly. You can use this function to define the mask based on "standard" waveforms. It compares the signal under test with the mask and displays the test results. When the pass/fail status is detected, you can choose to stop monitoring, sound an alarm with the beeper, or save the current screen image.

Click or tap the function navigation icon  at the lower-left corner of the screen to open the function navigation. Then click or tap the **Pass/Fail** button to enter the "PassFail" setting menu. You can also press the front-panel  key and select **Pass/Fail** to enter the "PassFail" setting menu. The menu is as shown in the figure below.

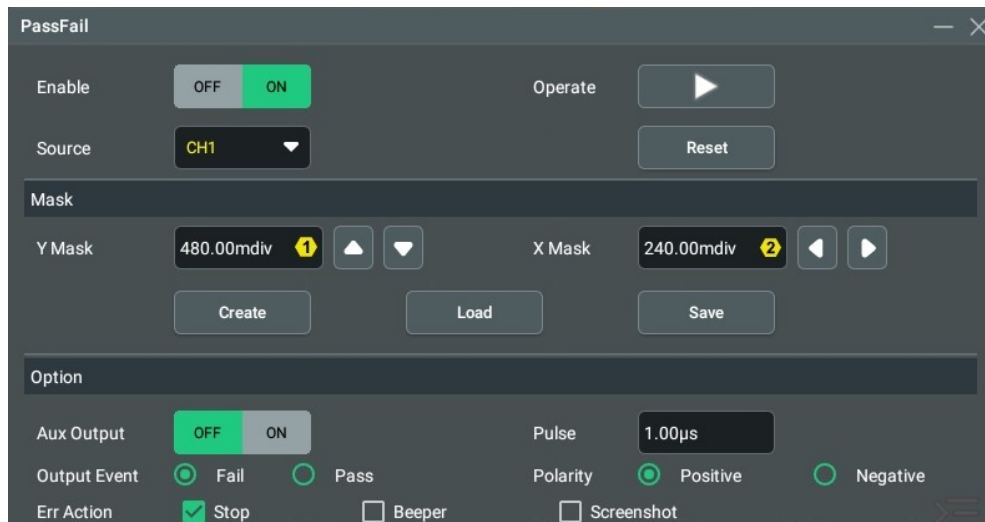

**Figure 17.1 PassFail Menu**

Click or tap  to minimize the "PassFail" menu to simplify the display. The minimized menu is displayed above the result bar on the right side of the screen, as shown in the figure below.



Figure 17.2 PassFail Menu-Simplified

## 17.1 To Enable or Disable the Pass/Fail Test Function

In the "Pass/Fail" setting menu, click or tap the **Enable** on/off switch to enable or disable the pass/fail test function.

You can select the source, create mask, and set test result output only after the pass/fail test function is enabled.

## 17.2 To Select the Source

Click or tap the drop-down button of **Source** to select the desired source. The available source channels include CH1-CH4.

### TIP

When a disabled channel is selected as the source, it will be automatically turned on.



## 17.3 To Set the Test Mask

In the **Pass/Fail** menu, you can self-define the pass/fail test mask, save and load the test mask.

### Create a Mask

Click or tap **X Mask** and **Y Mask** input fields respectively to set the horizontal tolerance range and vertical tolerance range with the pop-up numeric keypad. You can also use the icons at the right side of the input fields or use the corresponding multifunction knob to set the values. After configuring the settings, click or tap **Create** to apply the currently created mask (the region not covered by blue within the screen).

### Load a Mask

When the pass/fail test function is enabled, you can load the test mask files from the internal memory or external USB storage device (when detected) and apply them to the current pass/fail test function.

Click or tap **Load** to enter the file loading interface. Click or tap the input field of **File Path** to load the specified test mask files (in \*.pf format) and apply them to the current pass/fail test function. For detailed operations, refer to descriptions of *Disk Management* in *To Store and Load*.

### Save a Mask



When the pass/fail test function is enabled, you can save the current test mask range to the internal memory or an external USB storage device (when detected) in "\*.pf" format.

Click or tap **Save** to enter the file saving interface. Click or tap the input field of **File Name** and **File Path** to input the filename and select the desired file path to save the test mask file to the internal or external memory. For detailed operations, refer to descriptions of *Disk Management* in *To Store and Load*.

## 17.4 To Set the Output Form of the Test Results

In the "Option" menu of the pass/fail test interface, you can set the follow-up operations that the oscilloscope will operate when test results are generated according to your needs.

### Set the output event and Aux output

- Click or tap the **Aux Output** on/off switch to enable or disable the Aux output.
  - When enabled, click or tap the function navigation icon . In the **Utility** menu, the sub-menu **AUX Out** under the **Setup** menu is automatically set to "PassFail". When a successful or failed event is detected, a pulse will be output from the **[AUX OUT]** connector.
  - If disabled, click or tap the function navigation icon . In the **Utility** menu, the sub-menu **AUX Out** under the **Setup** menu is automatically set to "TrigOut". The output of the **[AUX OUT]** connector is irrelevant with the pass/fail test.
- Select "Pass" or "Fail" in **Output Event**. When a "pass" or "fail" event is detected, a pulse will be output from the rear-panel **[AUX OUT]** connector.

### Set the output polarity and output pulse width

Select "Positive" or "Negative" in **Polarity**, then click or tap the input field of **Pulse** to set the pulse width with the pop-up numeric keypad. You can also use the corresponding multifunction knob to set the value. Its range is from 100 ns to 10 ms. By default, it is 1  $\mu$ s.

### Set the error action



In **Err Action**, select one operation that the oscilloscope will execute once a pass/fail test is detected.

- **Stop:** stop sampling when a failed event is found.
- **Beeper:** the beeper sounds an alarm when a failed event is found (irrelevant with the on/off status of the beeper).
- **Screenshot:** perform the screenshot operation when a failed event is found. If an external storage device is detected, the screenshot will be saved to the external storage device directly. Otherwise, it will be saved to the local disk.

If "Screenshot" is selected, "Stop" action will be executed forcibly. The sampling stops automatically. After the screenshot operation is completed, the sampling will continue.

## 17.5 To Start or Stop the Pass/Fail Test Operation

After the Pass/Fail test function is enabled, click or tap the **Operate** button

 to start the test operation or  to stop the operation.

During the test process, the oscilloscope will test the waveforms, display the test information, and output the test information based on the current settings. The "**Pass/Fail**" result will be displayed in the "Result" bar at the right side of the screen, as shown in the figure below.

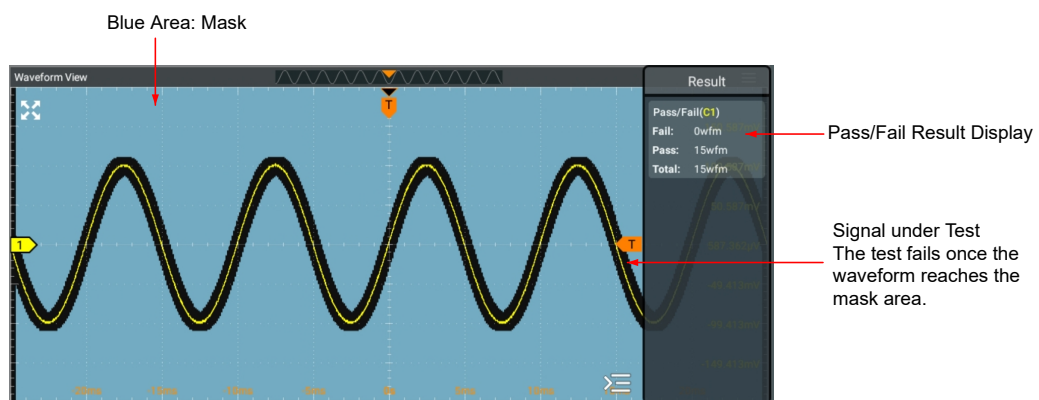



Figure 17.3 Pass/Fail Test Interface

**TIP**

- Only when the pass/fail test function is enabled, can you start or stop the pass/fail test operation, save and load the mask range.
- After starting the test operation, you can neither modify the source channel nor adjust the test mask.

## 17.6 To Display the Statistics of the Test Results

After the "Pass/Fail" function is enabled, the test results will be displayed in the "Result" bar at the right side of the screen. You can click or tap the icon  at the lower-right corner of the screen to hide the "Result" sidebar.

The test results statistics include the number of failed frames, the number of successful frames, and total number of frames, as shown in the figure below.

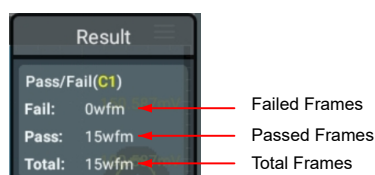

Click or tap the "Pass/Fail" label and a window is displayed for you to perform the following operations.

- Click or tap **Reset Stat.**, and then the statistics in the "Pass/Fail" label will be reset to 0.
- Click or tap **Setting**, and then the **PassFail** setting menu is displayed.
- Click or tap **Remove**, and then the pass/fail function is disabled.

## 18 Protocol Decoding

You can use the protocol analysis to discover errors, debug hardware, and accelerate development easily, ensuring you to accomplish the projects with high speed and good quality. Protocol decoding is the basis of protocol analysis. Only protocol analyses with correct protocol decoding are acceptable, and only correct protocol decoding can identify more error information. This oscilloscope provides four bus decoding modules (Decode 1, Decode 2, Decode 3, and Decode 4) to make common protocol decoding for the input signals of the analog channels. It provides standard serial decodes including Parallel, RS232/UART, I2C, SPI, LIN, CAN, and optional serial decodes including CAN-FD, FlexRay, I2S and MIL-STD1553. As the decoding functions and setting methods of Decode1, Decode2, Decode3, and Decode4 are the same, this chapter takes Decode1 as an example for illustration.

- Click or tap  > **Decode** to enter the "Decode" menu.
- Click or tap the **Decode** button on the toolbar to enter the "Decode" menu.

### 18.1 Parallel Decoding

Parallel bus consists of clock line and data line. As shown in the figure below, CLK is the clock line, whereas Bit0 and Bit1 are the 0 bit and 1st bit on the data line respectively. The oscilloscope will sample the channel data on the rising edge, falling edge, or the rising/falling edge of the clock and judge each data point (logic "1" or logic "0") according to the preset threshold level.

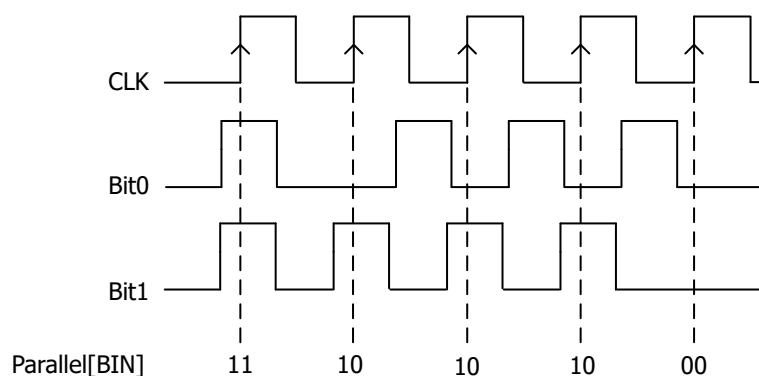

**Figure 18.1 Schematic Diagram of Parallel Decoding**

In the **Decode** menu, click or tap the drop-down button of **Bus Type** to select **Parallel**, then configure the parameters for Parallel decoding.

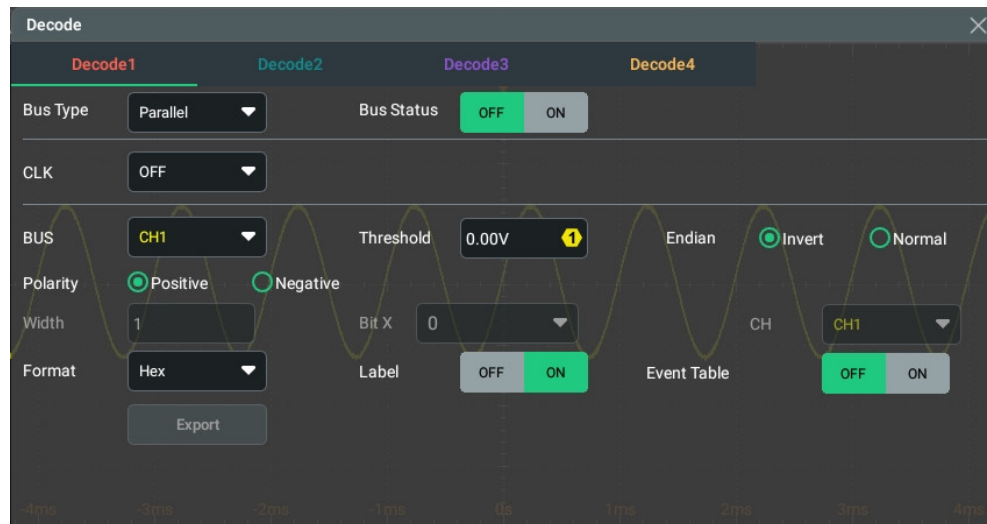

Figure 18.2 Parallel Decoding Menu

### Bus Status

Click or tap the ON/OFF tab for **Bus Status** to enable or disable the bus decoding.

## 18.1.1 Clock Setting (CLK)

### Clock Setting (CLK)

Click or tap the drop-down button of **CLK** to select the desired source of the clock channel. Available sources include analog channels CH1-CH4 and digital channels D0-D15. D0-D15 are available only when the digital channel probe is connected. If "OFF" is selected, no clock channel is set, and sampling is performed when a hop occurs to the data of the data channel during decoding.

### Threshold

You need to set a threshold when the clock signal is an analog channel (CH1-CH4). Click or tap the input field of **Threshold**, and then use the pop-up numeric keypad to set the threshold. You can also use the specified multifunction knob to set the value. The range of the threshold is related to the current vertical scale and offset.

### CLK Edge

You can select "**Rising**", "**Falling**", or "**Both**" in **CLK Edge** when the clock channel is set to an analog channel (CH1-CH4).

- **Rising:** samples the channel data on the rising edge of the clock.
- **Falling:** samples the channel data on the falling edge of the clock.
- **Both:** samples the channel data on the rising edge or the falling edge of the clock.

## 18.1.2 Bus Setting

### Set the Bus

Click or tap the drop-down button of **BUS** to select the desired bus. Available options include analog channels CH1-CH4 or digital channels D0-D15. You can also self-define the bus. Only when the digital channel probe is connected, can you select the digital channel (D0-D15) as the bus.

**Table 18.1 Bus Setting**

Bus	Width	Bit X	Channel	Remarks
CH1	1	0	CH1	Width, Bit X, and CH are set automatically, and you cannot modify them.
CH2	1	0	CH2	Width, Bit X, and CH are set automatically, and you cannot modify them.
CH3	1	0	CH3	Width, Bit X, and CH are set automatically, and you cannot modify them.
CH4	1	0	CH4	Width, Bit X, and CH are set automatically, and you cannot modify them.
D7-D0	8	0 (Default)	D7 (Default)	Bit0 to Bit7 are set to D7 to D0 respectively. Width is set automatically, and you cannot modify them.
D15-D8	8	0 (Default)	D15 (Default)	Bit0 to Bit7 are set to D15 to D8 respectively. Width is set automatically, and you cannot modify them.
D15-D0	16	0 (Default)	D15 (Default)	Bit0 to Bit15 are set to D15 to D0 respectively. Width is set automatically, and you cannot modify them.
D0-D7	8	0 (Default)	D0 (Default)	Bit0 to Bit7 are set to D0 to D7 respectively. Width is set

Bus	Width	Bit X	Channel	Remarks
				automatically, and you cannot modify them.
D8-D15	8	0 (Default)	D8 (Default)	Bit0 to Bit7 are set to D8 to D15 respectively. Width is set automatically, and you cannot modify them.
D0-D15	16	0 (Default)	D0 (Default)	Bit0 to Bit15 are set to D0 to D15 respectively. Width is set automatically, and you cannot modify them.
User	1 to 4, 1 for default	0 (Default)	-	-

### Set the Width

When the "BUS" setting is set to "User", you can set the bus width. Click or tap the input field of **Width**, and then use the pop-up numeric keypad to set the width. You can also use the corresponding multifunction knob to set the value.

### Specify data channel for each bit

When the "BUS" setting is set to "User", you can specify the data channel for each bit.

Click or tap **Bit X** set the bit of the channel. By default, 0 is selected. Its available range is from 0 to (width - 1).

Click or tap the drop-down button of **CH** to select the data channels for a bit. Available sources include analog channels CH1-CH4 or digital channels D0-D15. Only when the digital channel probe is connected, can you select the digital channel (D0-D15) as the data channel for the specified bit.

### Set the Threshold Level

To judge logic "1" and logic "0" of the buses, you need to set a threshold for each analog channel (CH1-CH4). When the channel signal amplitude is greater than the preset threshold, it is judged as logic "1"; otherwise logic "0".

Click or tap the input field of **Threshold**, and then use the pop-up numeric keypad to set the threshold. You can also use the specified multifunction knob to set the value. The range of the threshold is related to the current vertical scale and offset.

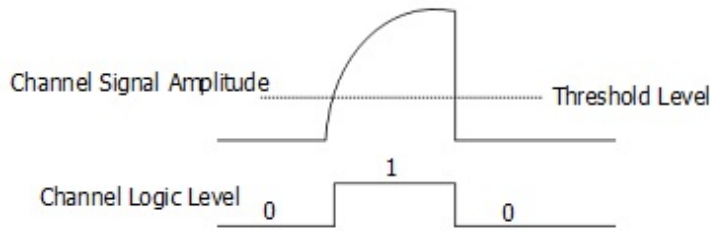

### Set the endian

In **Endian**, select "Invert" or "Normal" as the endian of the bus.

### Set the polarity

In **Polarity**, select "Positive" or "Negative" as the data polarity.

## 18.1.3 Display-related Settings

In **Decode** menu, set the following display-related parameters.

### Set the Display Format

Click or tap the drop-down button of **Format** to select the display format of the bus data and event table. The available options include "Hex", "Dec", "Bin", and "ASCII".

### Set the Label Display

Click or tap the **Label** on/off switch to enable or disable the label display of the decoding bus. When enabled, the bus label will be displayed at the upper-left side of the bus (when the bus display is enabled). The label shows the current bus type.

## 18.1.4 Event Table

The event table displays the decoded data and the specified decoding information in time order in the form of a table. It can be used to observe relatively longer decoded data. The decoding information includes the decoded data, the specified line number, and time information.

### Enable or Disable the Event Table

Click or tap the ON/OFF tab for **Event Table** to enable or disable the display of the event table. When enabled, the event table is displayed as shown in the figure below.

You can also click or tap the icon  at the upper-right corner of the table to close the event table.



Figure 18.3 Parallel Decoding Event Table



### TIP

- When you adjust the horizontal time base, the waveform displayed on the screen will also change, and the total number of lines containing the decoding information in the event table will also be changed.
- The displayed decoded data information in the bus is related to the value of the horizontal time base. Reducing the horizontal time base can help you view the detailed information.

### Export

When the operating status of the instrument is STOP, you can export the time and its corresponding decoding data from the current event table.

Click or tap **Export** to enter the file export interface. You can export the data list to the internal memory or the external USB storage device (only when detected) in \*.csv format. The detailed export operation is similar to the save operation, you can refer to relevant descriptions in *Store and Load*.

## 18.2 RS232 Decoding

RS232 serial bus consists of the transmitting data line (TX) and the receiving data line (RX).

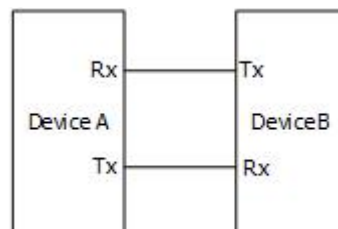

Figure 18.4 Schematic Diagram of RS232 Serial Bus

In RS232, baud rate is used to represent the transmission rate (namely bits per second) of the data. You need to set the start bit, data bits, check bit (optional), and stop bits for each frame of data.

Start Bit	Data Bit	Check Bit	Stop Bit
-----------	----------	-----------	----------

- **Start Bit:** indicates when to output data.
- **Data Bit:** indicates the number of data bits actually contained in each frame of data.
- **Check Bit:** used to check whether the data are properly transmitted.
- **Stop Bit:** indicates when to stop outputting data.

In the **Decode** menu, click or tap the drop-down button of **Bus Type** to select **RS232**, then configure the parameters for RS232 decoding.

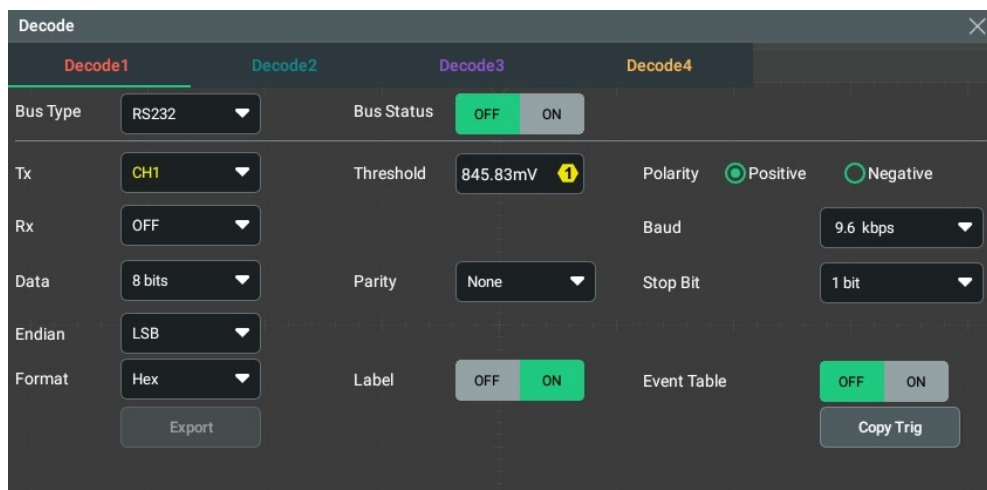

Figure 18.5 RS232 Decoding Menu

**Bus Status**

Click or tap the **Bus Status** on/off switch to enable or disable the bus decoding.

**Quickly Apply Trigger Settings to Decoding**

Copy trig indicates applying the trigger settings to the specified decoding setting.

Click or tap **Copy Trig** to apply the trigger settings to the specified decoding setting.

## 18.2.1 Source Setting

### Set the Tx source and the threshold

Click or tap the drop-down button of **Tx** to select the desired source. The options include CH1-CH4, D0-D15, and OFF. Only when the digital channel probe is connected, can you select the digital channel (D0-D15) as the Tx source.

When the source is set to CH1-CH4, you can click or tap the input field of **Threshold**, and then use the pop-up numeric keypad to set the threshold of Tx source. You can also use the corresponding multifunction knob to set the value. The range of the threshold is related to the current vertical scale and offset.

When you modify the threshold of the Tx source channel, a dotted line displaying the current threshold level is displayed on the screen. It disappears in about 2 s after you stop modifying the threshold.

### Set the Rx source and the threshold

Use the same method to select the **Rx** source and set the threshold. The default state of **Rx** is OFF.

#### TIP

The sources of **Tx** and **Rx** cannot be set to OFF at the same time.

### Polarity

Click or tap "**Positive**" or "**Negative**" in **Polarity**.

- **Positive:** High level is logic "1" and low level is logic "0".
- **Negative:** High level is logic "0" and low level is logic "1".

### Set the baud rate

Click or tap the drop-down button of **Baud** to select the baud rate. The available baud rates include 50 bps, 75 bps, 110 bps, 134 bps, 150 bps, and etc.

The oscilloscope allows you to self-define the baud rate. Click or tap the drop-down button of **Baud** to select "User" and then set the baud rate with the pop-up numeric keypad.

## 18.2.2 To Set Data Package

### Data

Click or tap the drop-down button of **Data** to select the data bits. The available data bits are 5 bits, 6 bits, 7 bits, 8 bits, and 9 bits.

## Parity

It is used to check whether the data transmission is correct. Click or tap the drop-down button of **Parity** to select the desired parity mode.

- **None:** indicates that no check bit appears during the transmission.
- **Even:** indicates that the total number of "1" in the data bit and check bit is an even number. For example, when 0x55 (01010101) is sent, "0" should be added to the check bit.
- **Odd:** indicates that the total number of "1" in the data bit and check bit is an odd number. For example, when 0x55 (01010101) is sent, "1" should be added to the check bit.

## Stop Bit

Click or tap the drop-down button of **Stop Bit** to set the stop bits after each frame of data. It can be set to 1 bit, 1.5 bits, or 2 bits.

## Endian

Click or tap the drop-down button of **Endian** to select the desired endian.

- **LSB:** indicates Least Significant Bit transmission sequence, i.e. the lowest bit of the data is transmitted first.
- **MSB:** indicates Most Significant Bit transmission sequence, i.e. the highest bit of the data is transmitted first.

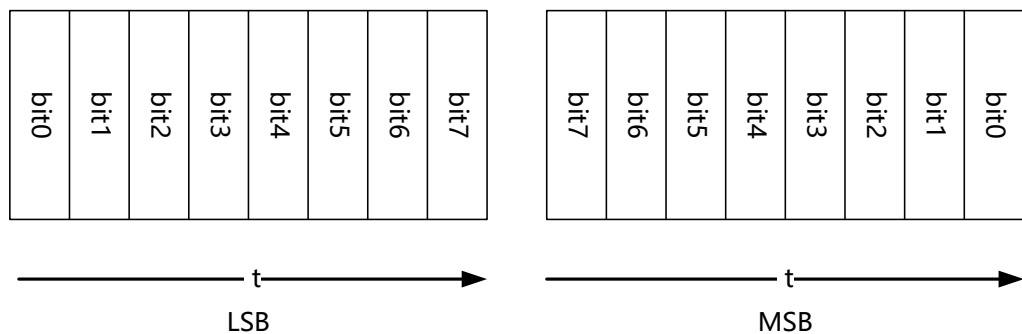

## 18.2.3 Display-related Settings

In **Decode** menu, set the following display-related parameters.

### Set the Display Format

Click or tap the drop-down button of **Format** to select the display format of the bus data and event table. The available options include "Hex", "Dec", "Bin", and "ASCII".

## Set the Label Display

Click or tap the **Label** on/off switch to enable or disable the label display of the decoding bus. When enabled, the bus label will be displayed at the upper-left side of the bus (when the bus display is enabled). The label shows the current bus type.

## 18.2.4 Event Table

Click or tap the ON/OFF tab for **Event Table** to enable or disable the display of the event table. When enabled, the event table is displayed as shown in the figure below.

You can also click or tap the icon  at the upper-right corner of the table to close the event table.

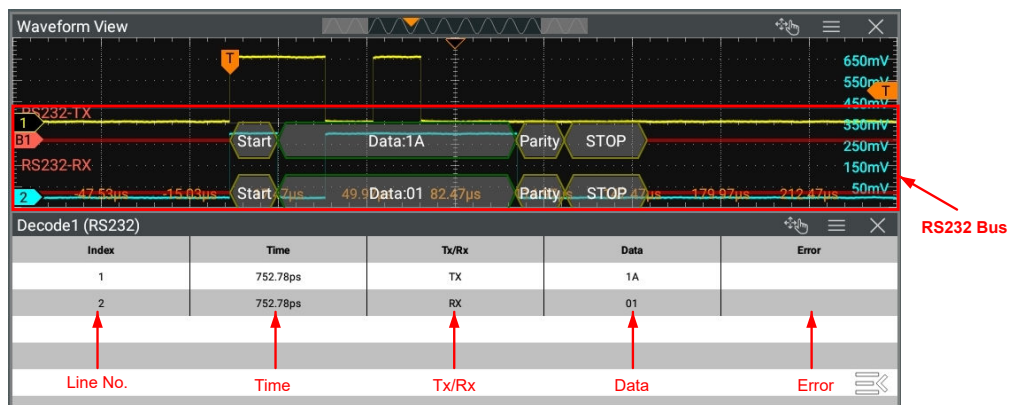

Figure 18.6 RS232 Decoding Event Table



### TIP

- When you adjust the horizontal time base, the waveform displayed on the screen will also change, and the total number of lines containing the decoding information in the event table will also be changed.
- The displayed decoded data information in the bus is related to the value of the horizontal time base. Reducing the horizontal time base can help you view the detailed information.

### Export

When the oscilloscope is in "STOP" state, you can export the time and its corresponding decoded data in the event table.

In Decode menu, click or tap **Export**, then the save setting interface is displayed. You can export the data to the internal memory or the external USB storage device (only when detected) in \*.csv format. For details, refer to [Store and Load](#).

## 18.3 I2C Decoding

I2C serial bus consists of the clock line (SCL) and the data line (SDA).

**SCL:** samples SDA on the rising or falling edge of the clock.

**SDA:** indicates the data channel.

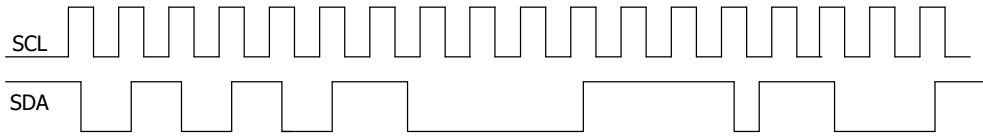

Figure 18.7 I2C Serial Bus

In the **Decode** menu, click or tap the drop-down button of **Bus Type** to select **I2C**, then configure the parameters for I2C decoding.

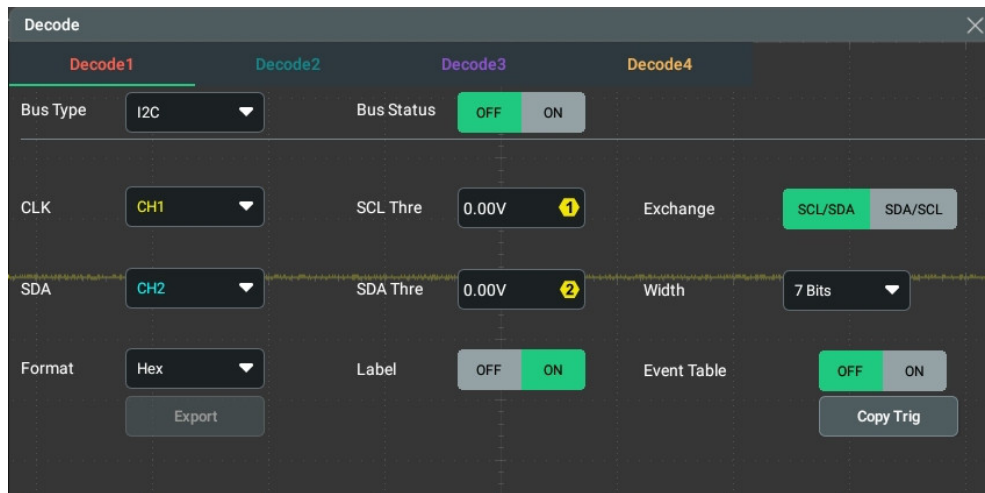

Figure 18.8 I2C Decoding Menu

**Bus Status**

Click or tap the ON/OFF tab for **Bus Status** to enable or disable the bus decoding.

**Quickly Apply Trigger Settings to Decoding**

Copy trig indicates applying the trigger settings to the specified decoding setting.

Click or tap **Copy Trig** to apply the trigger settings to the specified decoding setting.

**18.3.1 Source Setting**

**Set the Clock Channel and Data Channel**

- You can select analog channels or digital channels as the source for **CLK**. When the source is set to the analog channel, set the **SCL Thre** value with the numeric keypad or multifunction knob.

When you modify the threshold of the clock channel, a dotted line displaying the current threshold level is displayed on the screen. It disappears in about 2 s after you stop modifying the threshold.

- You can select analog channels or digital channels as the source for **SDA**. When the source is set to the analog channel, set the **SDA Thre** value with the numeric keypad or multifunction knob.

For the available channels of each model refer to *Content Conventions in this Manual*.

### Exchange sources

Select "SCL/SDA" or "SDA/SCL" in **Exchange** to exchange the sources of the current clock channel and data channel.

### Set the Address Width

Click or tap the drop-down button of **Width** to select the address width. The available options include 7 Bits, 8 Bits, or 10 Bits. When "7 Bits" is selected, R/W bit is not included in the address. When "8 Bits" or "10 Bits" is selected, R/W bit is included in the address.

- 7:** In 7-bit addressing, after the START condition, a slave address is sent. The address starts to transfer from the first byte, as shown in the figure below. The first seven bits of the first byte make up the slave address, and the eighth bit is the LSB (least significant bit) which determines the direction of the message, also called a data direction bit (R/W). A "zero" indicates a transmission (WRITE), a "one" indicates a request for data (READ).

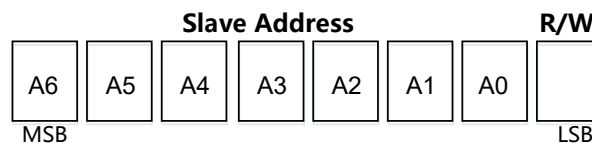

- 8:** same as the 7-bit addressing. A R/W bit is included in the 8-bit addressing for the slave address.
- 10:** 10-bit addressing is compatible with 7-bit addressing. As shown in the figure below, in 10-bit addressing, the first byte is the special reserved address 10-bit Address Indicator to indicate the current 10-bit address that is transferring.

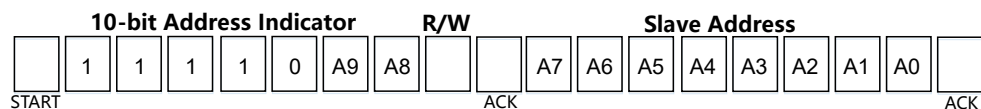

## 18.3.2 Display-related Settings

In **Decode** menu, set the following display-related parameters.

### Set the Display Format

Click or tap the drop-down button of **Format** to select the display format of the bus data and event table. The available options include "Hex", "Dec", "Bin", and "ASCII".

### Set the Label Display

Click or tap the **Label** on/off switch to enable or disable the label display of the decoding bus. When enabled, the bus label will be displayed at the upper-left side of the bus (when the bus display is enabled). The label shows the current bus type.

## 18.3.3 Event Table

### Enable or Disable the Event Table

Click or tap the ON/OFF tab for **Event Table** to enable or disable the display of the event table. When enabled, the event table is displayed as shown in the figure below.

You can also click or tap the icon  at the upper-right corner of the table to close the event table.

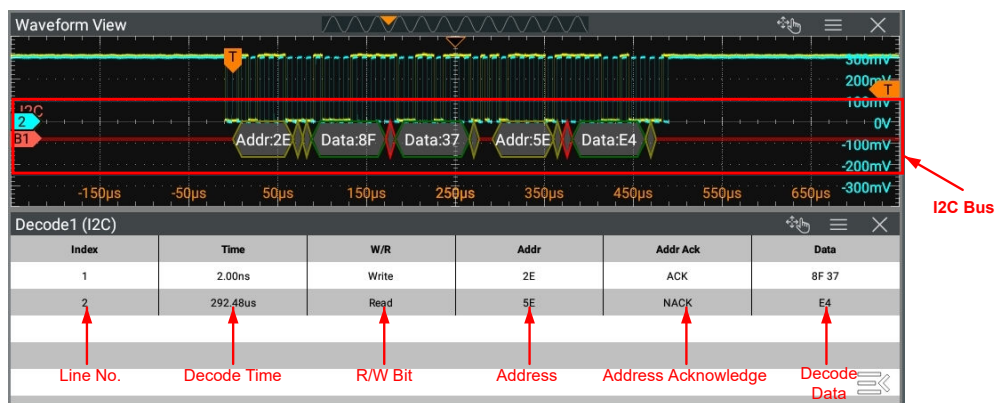

Figure 18.9 I2C Decoding Event Table



### TIP

- When you adjust the horizontal time base, the waveform displayed on the screen will also change, and the total number of lines containing the decoding information in the event table will also be changed.
- The displayed decoded data information in the bus is related to the value of the horizontal time base. Reducing the horizontal time base can help you view the detailed information.

### Export

When the oscilloscope is in "STOP" state, you can export the time and its corresponding decoded data in the event table.

In Decode menu, click or tap **Export**, then the save setting interface is displayed. You can export the data to the internal memory or the external USB storage device (only when detected) in \*.csv format. For details, refer to *Store and Load*.

### Address information in decoding

For I2C bus, each frame of data starts with the address information (read address and write address). The address is displayed in the format "Addr: xx". When the **Width** is set to 7 Bits, the address field is followed by "read" or "write" to indicate whether it is a read or write address. You can decide whether to include or exclude the "R/W" bit for the address information.

### Error expressions in decoding

In I2C decoding, the response includes ACK (acknowledgment) and NACK (non-acknowledgment). When NACK is detected after "Write", red error report information is displayed.

## 18.4 SPI Decoding

SPI bus is based on the master — slave configuration and usually consists of chip select line (CS), clock line (CLK), and data line (SDA). Wherein, the data lines include the master input/slave output (MISO) data line and master output/slave input (MOSI) data line. The oscilloscope samples the channel data on the rising or falling edge of the clock signal and judge each data point (logic "1" or logic "0") according to the preset threshold level.

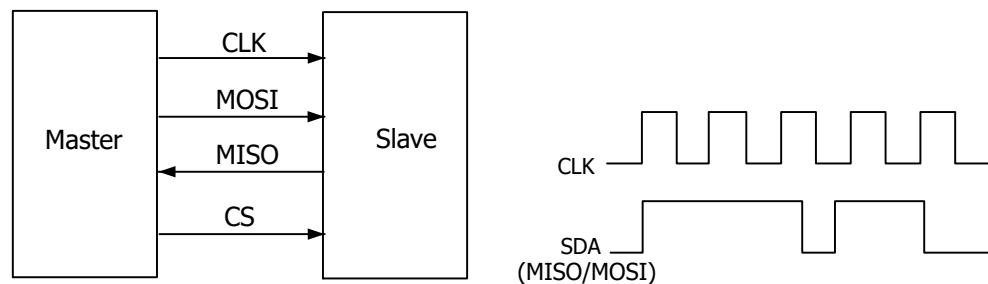

Figure 18.10 SPI Serial Bus

In the **Decode** menu, click or tap the drop-down button of **Bus Type** to select **SPI**, then configure the parameters for SPI decoding.

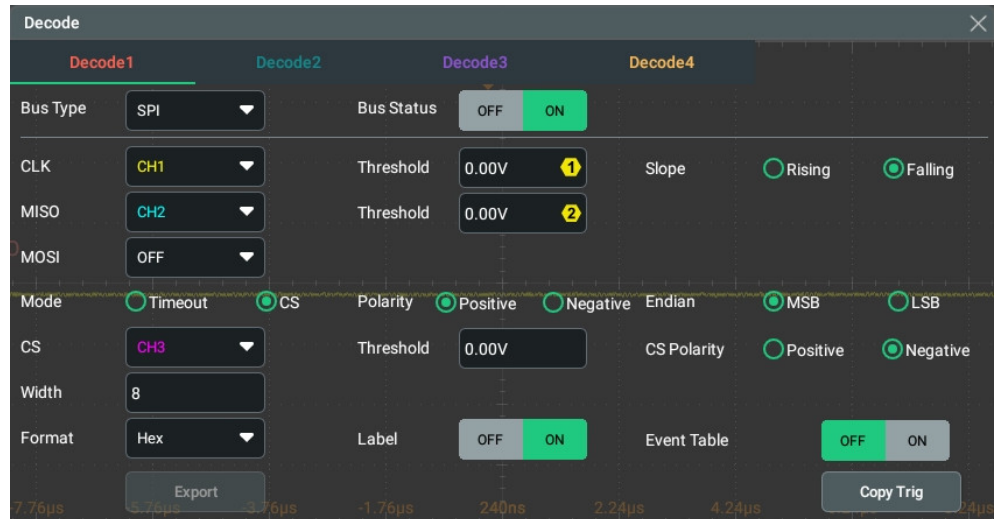

Figure 18.11 SPI Decoding Menu

### Bus Status

Click or tap the ON/OFF tab for **Bus Status** to enable or disable the bus decoding.

### Quickly Apply Trigger Settings to Decoding

Copy trig indicates applying the trigger settings to the specified decoding setting.

Click or tap **Copy Trig** to apply the trigger settings to the specified decoding setting.

## 18.4.1 Source Setting

### Set the Clock Signal

- Click or tap the drop-down button of **CLK** to select the desired source of the clock channel. Available sources include analog channels CH1-CH4 and digital channels D0-D15. D0-D15 are available only when the digital channel probe is connected.
- Click or tap the input field of **Threshold** at the right side of **CLK** and use the pop-up numeric keypad to set the threshold of the clock channel when an analog channel (CH1-CH4) is selected. You can also use the corresponding multifunction knob to set the value.
- Click or tap "Rising" or "Falling" in **Slope** to set the instrument to sample MISO and MOSI on the CLK edge.

### MISO and MOSI Setting

- Click or tap the drop-down button of **MISO** to select the desired source. Available sources include analog channels CH1-CH4, digital channels D0-D15, and OFF. D0-D15 are available only when the digital channel probe is connected.

- When the MISO source is set to CH1-CH4, you can click or tap the input field of **Threshold** at the right side of **MISO**, and then use the pop-up numeric keypad to set the threshold of the MISO channel. You can also use the corresponding multifunction knob to set the value.
- Click or tap the drop-down button of **MOSI** to select the desired source. Available sources include analog channels CH1-CH4, digital channels D0-D15, and OFF. D0-D15 are available only when the digital channel probe is connected.
- When the MOSI source is set to CH1-CH4, you can click or tap the input field of **Threshold** at the right side of **MOSI**, and then use the pop-up numeric keypad to set the threshold of the MOSI channel. You can also use the corresponding multifunction knob to set the value.

**TIP**

The MISO and MOSI sources cannot be set to "OFF" at the same time.

## 18.4.2 To Set the Mode and Data

### Mode

Select "Timeout" or "CS" in **Mode**.

- **Timeout**

You can perform frame synchronization according to the timeout. The timeout value must be greater than half of the clock cycle. Click or tap the input field of **Timeout**, and then use the pop-up numeric keypad to set the timeout value. You can also use the corresponding multifunction knob to set the value. The adjustable range of the timeout value is from 8 ns to 10 s. By default, it is 1  $\mu$ s.

- **CS**

Indicates the chip select line (CS). You can perform frame synchronization according to CS. When "CS" is selected,

- Click or tap the drop-down button of **CS** to select the desired source. The sources include analog channels CH1-CH4 and digital channels D0-D15 (available only when the digital channel probe is connected).
- Click or tap the input field of **Threshold** and use the pop-up numeric keypad to set the threshold when an analog channel (CH1-CH4) is selected as the CS channel. You can also use the corresponding multifunction knob to set the value.
- In **CS Polarity**, select "**Positive**" or "**Negative**".

## Endian

Click or tap the drop-down button of **Endian** to select the desired endian.

- **LSB:** indicates Least Significant Bit transmission sequence, i.e. the lowest bit of the data is transmitted first.
- **MSB:** indicates Most Significant Bit transmission sequence, i.e. the highest bit of the data is transmitted first.

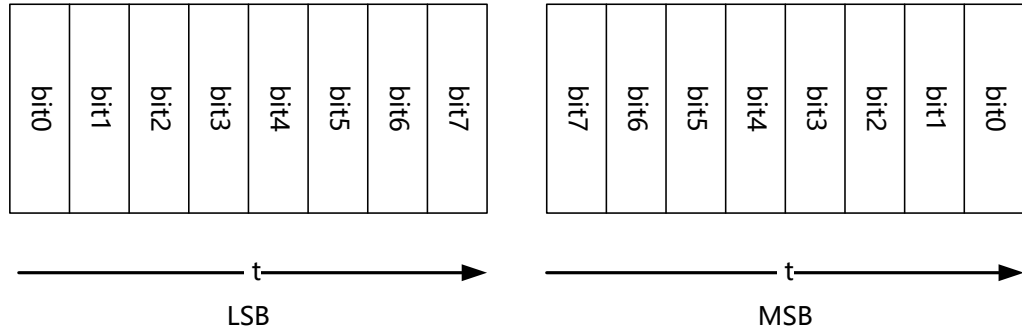

## Polarity

In **Polarity**, select "**Positive**" or "**Negative**" as the data polarity.

## Width Setting

Click or tap the input field of **Width**, and then use the pop-up numeric keypad to set the length of the data. You can also use the corresponding multifunction knob to set the value. The setting range is from 4 to 32. By default, it is 8.

## 18.4.3 Display-related Settings

In **Decode** menu, set the following display-related parameters.

### Set the Display Format

Click or tap the drop-down button of **Format** to select the display format of the bus data and event table. The available options include "**Hex**", "**Dec**", "**Bin**", and "**ASCII**".

### Set the Label Display

Click or tap the **Label** on/off switch to enable or disable the label display of the decoding bus. When enabled, the bus label will be displayed at the upper-left side of the bus (when the bus display is enabled). The label shows the current bus type.

## 18.4.4 Event Table

### Enable or Disable the Event Table

Click or tap the ON/OFF tab for **Event Table** to enable or disable the display of the event table. When enabled, the event table is displayed as shown in the figure below.

You can also click or tap the icon  at the upper-right corner of the table to close the event table.

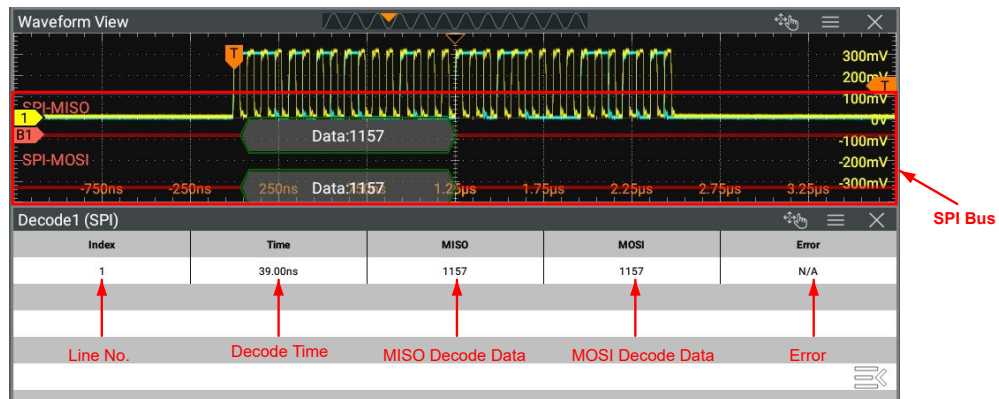

Figure 18.12 SPI Decoding Event Table



#### TIP

- When you adjust the horizontal time base, the waveform displayed on the screen will also change, and the total number of lines containing the decoding information in the event table will also be changed.
- The displayed decoded data information in the bus is related to the value of the horizontal time base. Reducing the horizontal time base can help you view the detailed information.

#### Export

When the oscilloscope is in "STOP" state, you can export the time and its corresponding decoded data in the event table.

In Decode menu, click or tap **Export**, then the save setting interface is displayed. You can export the data to the internal memory or the external USB storage device (only when detected) in \*.csv format. For details, refer to [Store and Load](#).

## 18.5 LIN Decoding

The oscilloscope samples the LIN signal, and judges each data point to be logic "1" or logic "0" according to the preset threshold level. The LIN decoding is required to specify the LIN signal protocol version.

In the **Decode** menu, click or tap the drop-down button of **Bus Type** to select **LIN**, then configure the parameters for LIN decoding.

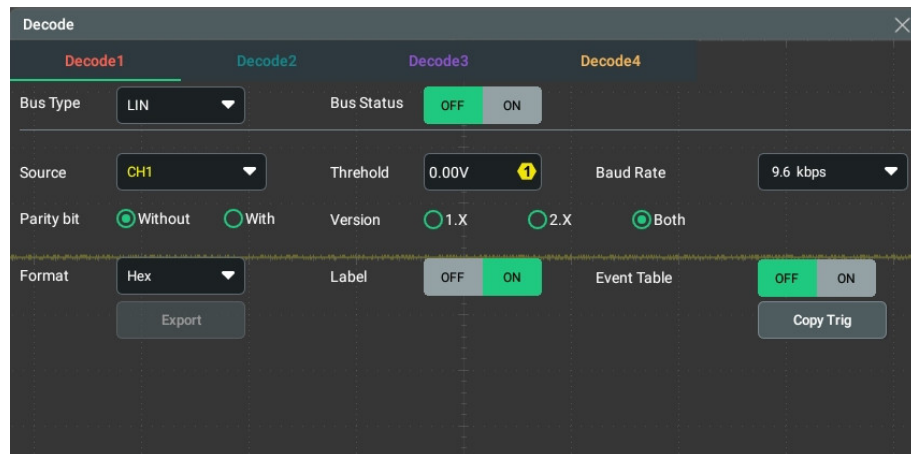

Figure 18.13 LIN Decoding Menu

### Bus Status

Click or tap the ON/OFF tab for **Bus Status** to enable or disable the bus decoding.

### Quickly Apply Trigger Settings to Decoding

Copy trig indicates applying the trigger settings to the specified decoding setting.

Click or tap **Copy Trig** to apply the trigger settings to the specified decoding setting.

## 18.5.1 Signal Configuration

### Set the source and the threshold

- Click or tap the drop-down button of **Source** to select the desired source. Available sources include analog channels CH1-CH4 and digital channels D0-D15 (available only when the digital channel probe is connected).
- When the source is set to an analog channel, click or tap the input field of **Threshold**, and then use the pop-up numeric keypad to set the threshold of the source channel. You can also use the corresponding knob to set the value.

When you modify the threshold of the signal source, a dotted line displaying the current threshold level is displayed on the screen. It disappears in about 2 s after you stop modifying the threshold.

### Set the Signal

- Click or tap the drop-down button of **Baud Rate** to select the baud rate. The available baud rates include 2.4 kbps, 4.8 kbps, 9.6 kbps, 10.0 kbps, 19.2 kbps, and etc. You can also self-define the baud rate.
- In **Parity bit**, click or tap **"With"** or **"Without"** to select whether the data contain the parity bit.

- In **Version**, select the protocol version that matches the LIN bus signal. The available versions include "1.X", "2.X", and "Both".

## 18.5.2 Display-related Settings

In **Decode** menu, set the following display-related parameters.

### Set the Display Format

Click or tap the drop-down button of **Format** to select the display format of the bus data and event table. The available options include "Hex", "Dec", "Bin", and "ASCII".

### Set the Label Display

Click or tap the **Label** on/off switch to enable or disable the label display of the decoding bus. When enabled, the bus label will be displayed at the upper-left side of the bus (when the bus display is enabled). The label shows the current bus type.

## 18.5.3 Event Table

### Enable or Disable the Event Table

Click or tap the ON/OFF tab for **Event Table** to enable or disable the display of the event table. When enabled, the event table is displayed as shown in the figure below.

You can also click or tap the icon  at the upper-right corner of the table to close the event table.

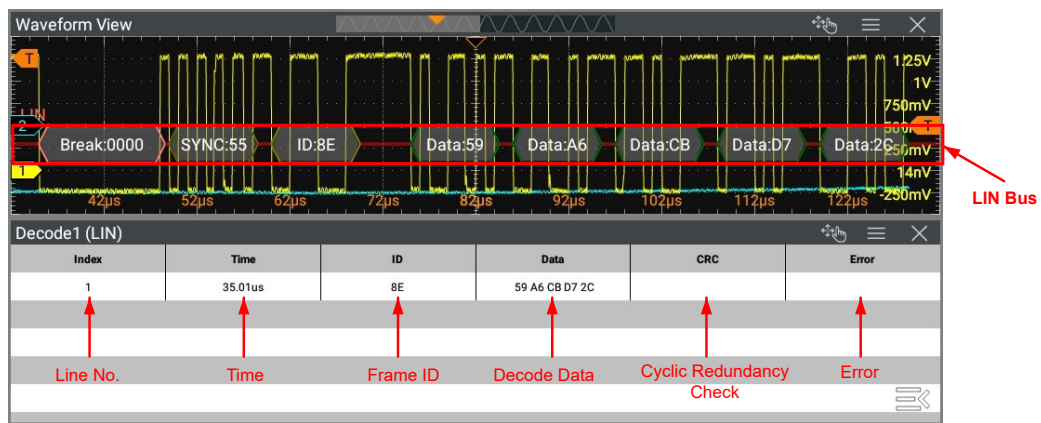

Figure 18.14 LIN Decoding Event Table



### TIP

- When you adjust the horizontal time base, the waveform displayed on the screen will also change, and the total number of lines containing the decoding information in the event table will also be changed.

- The displayed decoded data information in the bus is related to the value of the horizontal time base. Reducing the horizontal time base can help you view the detailed information.

### Export

When the oscilloscope is in "STOP" state, you can export the time and its corresponding decoded data in the event table.

In Decode menu, click or tap **Export**, then the save setting interface is displayed. You can export the data to the internal memory or the external USB storage device (only when detected) in \*.csv format. For details, refer to *Store and Load*.

### Interpret the Decoded LIN Data

- Break (Sync Break): expressed in Hex, identified as "Break:".
- SYNC (Sync): expressed in Hex, identified as "SYNC:".
- ID (Frame ID): expressed in Hex, identified as "ID:".
- Data (Data): Its display format is the same as that of the bus data (Hex, Dec, Bin, or ASCII), identified as "Data:".
- CRC (Cyclic Redundancy Check): expressed in Hex, identified as "CRC:". When errors occur, it is displayed as a red patch.
- Wakeup (wake up symbol): identified as "Wakeup:".

## 18.6 CAN Decoding

The oscilloscope samples the CAN or CAN-FD (option) signal at the specified sample position, and judges each data point to be logic "1" or logic "0" according to the preset threshold level. You need to specify the CAN or CAN-FD signal type and sample position.

In the **Decode** menu, click or tap the drop-down button of **Bus Type** to select **CAN**, then configure the parameters for CAN decoding. The **CAN-FD Baud** and **FD Sample Position** items are available only when the CAN-FD option is installed and enabled. The CAN-FD Baud item specifies the baud rate of the CAN-FD bus.

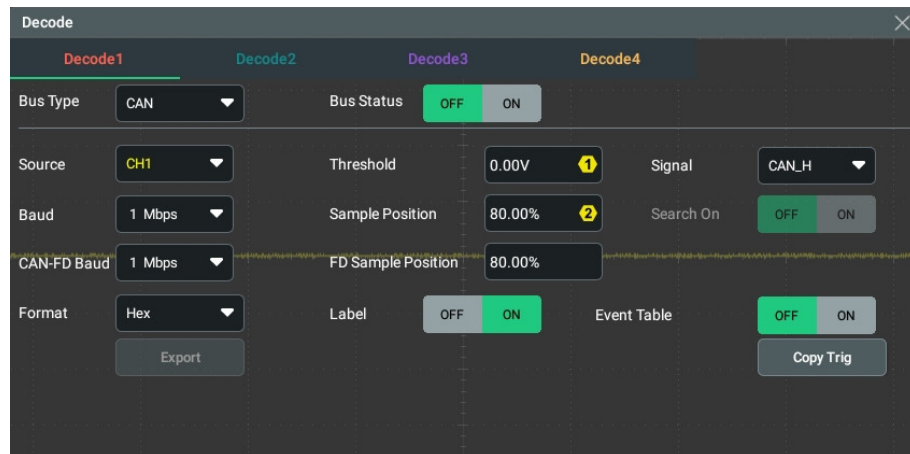

Figure 18.15 CAN Decoding Menu

### Bus Status

Click or tap the **Bus Status** on/off switch to enable or disable the bus decoding.

### Quickly Apply Trigger Settings to Decoding

Copy trig indicates applying the trigger settings to the specified decoding setting.

Click or tap **Copy Trig** to apply the trigger settings to the specified decoding setting.

## 18.6.1 Signal Configuration

### Set the Source and the Threshold

- Click or tap the drop-down button of **Source** to select the analog channels or digital channels as the desired source. Only when the digital channel probe is connected, can you select the digital channel (D0-D15).
- When the source is set to an analog channel, click or tap the input field of **Threshold**, and then use the pop-up numeric keypad to set the threshold of the source channel. You can also use the corresponding multifunction knob to set the value.

When you modify the threshold of the signal source, a dotted line displaying the current threshold level is displayed on the screen. It disappears in about 2 s after you stop modifying the threshold.

### Select the Signal Type

Click or tap the drop-down button of **Signal** to select a signal type that matches the CAN bus signal. The available signal types include CAN\_H, CAN\_L, Rx, Tx, and Diff.

- CAN\_H**: indicates the actual CAN\_H bus signal.
- CAN\_L**: indicates the actual CAN\_L bus signal.

- **Rx:** indicates the Receive signal from the CAN bus transceiver.
- **Tx:** indicates the Transmit signal from the CAN bus transceiver.
- **Diff:** indicates the CAN differential bus signals connected to an signal source channel by using a differential probe. Connect the probe's positive lead to the CAN\_H bus signal and connect the negative lead to the CAN\_L bus signal.

### Specify the Standard Signal Rate

Click or tap the drop-down button of **Baud** to select the preset baud rate. The available baud rates include 10.0 kbps, 19.2 kbps, 20.0 kbps, 33.3 kbps and etc. You can also set a user-defined baud rate.

### Sample Position

Sample position is a point within a bit's time. The oscilloscope samples the bit level at this point. The sample position is represented by the proportion of "the time from the start of the bit to the sample point" to the "bit time", as shown in the figure below.

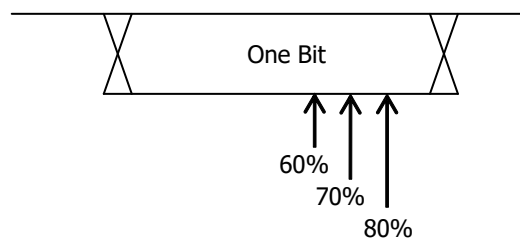

Figure 18.16 Sample Position

### Set the CAN-FD Baud

CAN-FD baud rate is a dedicated setting for the CAN-FD decoding. It is available only when the CAN-FD option is installed. Click or tap the drop-down button of **CAN-FD Baud** to select the variable baud rate from the drop-down list. The available baud rates include 1 Mbps, 2 Mbps, 3 Mbps, 4 Mbps, and etc.

### FD Sample Position

FD sample position is a dedicated setting for the CAN-FD decoding. It is available only when the CAN-FD option is installed. Click or tap the input field of **FD Sample Position** and use the pop-up numeric keypad to set the value. You can also use the specified multifunction knob to set the value. The settable range is from 10% to 90%.

## 18.6.2 Display-related Settings

In **Decode** menu, set the following display-related parameters.

## Set the Display Format

Click or tap the drop-down button of **Format** to select the display format of the bus data and event table. The available options include "Hex", "Dec", "Bin", and "ASCII".

## Set the Label Display

Click or tap the **Label** on/off switch to enable or disable the label display of the decoding bus. When enabled, the bus label will be displayed at the upper-left side of the bus (when the bus display is enabled). The label shows the current bus type.

## 18.6.3 Event Table

When enabled the Event Table, the decoding event table is displayed on the screen. The decoding information of the signal is displayed in the event table window.

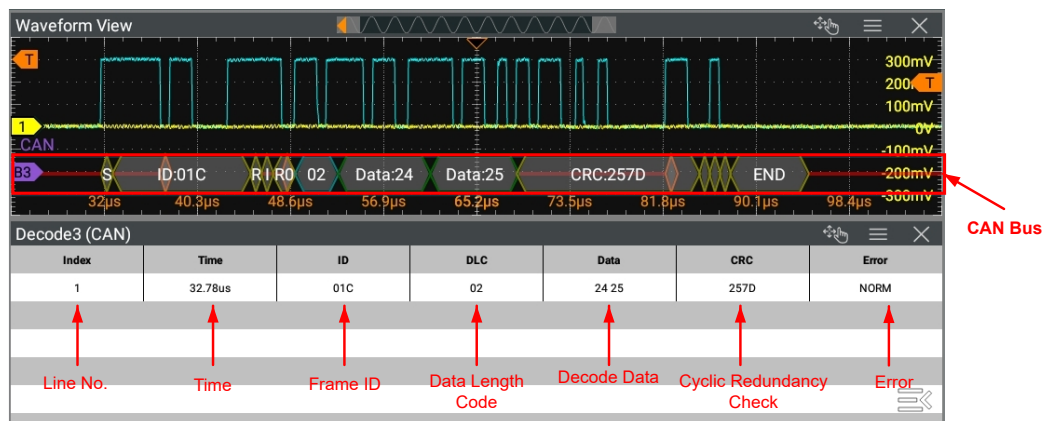

Figure 18.17 CAN Decoding Event Table



### TIP

- When you adjust the horizontal time base, the waveform displayed on the screen will also change, and the total number of lines containing the decoding information in the event table will also be changed.
- The displayed decoded data information in the bus is related to the value of the horizontal time base. Reducing the horizontal time base can help you view the detailed information.

### Search ID

When the event table is enabled and the operating status of the oscilloscope is STOP (stopping acquisition), you can search for the event with the specified ID from the current event table. When you enable "Search On" and input the specified search ID, the event table will only display the event with specified ID.

### Export

When the oscilloscope is in "STOP" state, you can export the time and its corresponding decoded data in the event table.

In Decode menu, click or tap **Export**, then the save setting interface is displayed. You can export the data to the internal memory or the external USB storage device (only when detected) in \*.csv format. For details, refer to *Store and Load*.

### Interpret the CAN Decoding Frame Structure

- **Frame ID:** expressed in Hex, identified as "ID:".
- **DLC (Payload Length):** expressed in Hex, identified as "DLC:".
- **Data:** Its display format is the same as that of the bus data (Hex, Dec, Bin, or ASCII), identified as "Data:".
- **CRC (Cyclic Redundancy Check):** expressed in Hex, identified as "CRC:".
- **ACK (Acknowledgement):** identified as "ACK". When errors (ACK is detected to be 1) occur, it is displayed as a red patch.
- **R (remote frame):** identified as "R:".
- **Stuff (Bit filling error):** identified as "Stuff".

## 18.7 I2S Decoding(Optional)

The oscilloscope samples the I2S signal, and judges each data point to be logic "1" or logic "0" according to the preset threshold level. I2S decoding is required to specify the serial clock, channel signal, and the data's source channel. You need to set Alignment, WS Low, and other parameters.

In the **Decode** menu, click or tap the drop-down button of **Bus Type** to select **I2S**, then configure the parameters for I2S decoding.

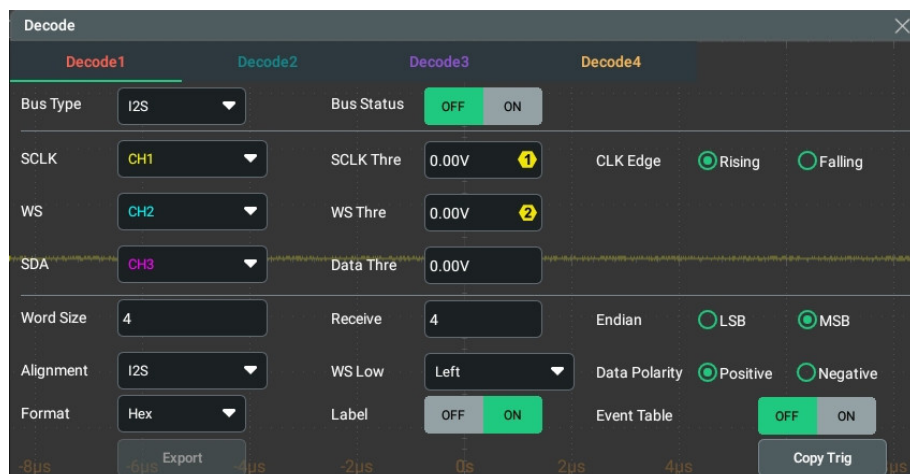

Figure 18.18 I2S Decoding Menu

### Bus Status

Click or tap the ON/OFF tab for **Bus Status** to enable or disable the bus decoding.

## Quickly Apply Trigger Settings to Decoding

Copy trig indicates applying the trigger settings to the specified decoding setting.

Click or tap **Copy Trig** to apply the trigger settings to the specified decoding setting.

## 18.7.1 Source Setting

### Set the SCLK Source and Threshold

- Click or tap the drop-down button of **SCLK** to select the analog channels or digital channels as the serial serial clock source.
- Click or tap the input field of **SCLK Thre** to set the threshold with the pop-up numeric keypad. You can also use multifunction knob to set the threshold. When you modify the threshold of the clock channel, a dotted line displaying the current threshold level is displayed on the screen. It disappears in about 2 s after you stop modifying the threshold.
- In **CLK Edge** menu, click or tap to select "Rising" or "Falling" as the desired clock edge.

### Set the WS Source and Threshold

- Click or tap the drop-down button of **WS** to select the analog channels or digital channels as the WS source.
- Click or tap the input field of **WS Thre** to set the WS threshold with the pop-up numeric keypad. You can also use multifunction knob to set the WS threshold. When you modify the WS threshold, a dotted line displaying the current threshold level is displayed on the screen. It disappears in about 2 s after you stop modifying the threshold.

### Set the SDA Source and Threshold

- Click or tap the drop-down button of **SDA** to select the analog channels or digital channels as the SDA source.
- Click or tap the input field of **Data Thre** to set the data threshold with the pop-up numeric keypad. You can also use the multifunction knob to set the data threshold. When you modify the data threshold, a dotted line displaying the current threshold level is displayed on the screen. It disappears in about 2 s after you stop modifying the threshold.



#### NOTE

For the available channels of each model refer to *Content Conventions in this Manual*.

## 18.7.2 Bus Setting

---

### Set the Word Size

You can use the pop-up numeric keypad to set **Word Size**. Its range is from 4 to 32.

### Set the Receive Word Size

You can use the pop-up numeric keypad to set **Receive**. Its range is from 4 to 32.

### Set the Endian

In **Endian** menu, click or tap to select "**LSB**" or "**MSB**". By default, it is "MSB".

### Set the Alignment Mode

Click the drop-down menu of the **Alignment** item to select the data signal alignment as **I2S**, **LJ** or **RJ**.

### Set the Audio Polarity

Click or tap the drop-down button of **WS Low** to select "**Left**" or "**Right**".

### Set the Data Polarity

In **Data Polarity** menu, click or tap to select "**Positive**" or "**Negative**".

## 18.7.3 Display-related Settings

---

In **Decode** menu, set the following display-related parameters.

### Set the Display Format

Click or tap the drop-down button of **Format** to select the display format of the bus data and event table. The available options include "**Hex**", "**Dec**", "**Bin**", and "**ASCII**".

### Set the Label Display

Click or tap the **Label** on/off switch to enable or disable the label display of the decoding bus. When enabled, the bus label will be displayed at the upper-left side of the bus (when the bus display is enabled). The label shows the current bus type.

## 18.7.4 Event Table

---

When enabled the Event Table, the decoding event table is displayed on the screen. The decoding information of the signal is displayed in the event table window.

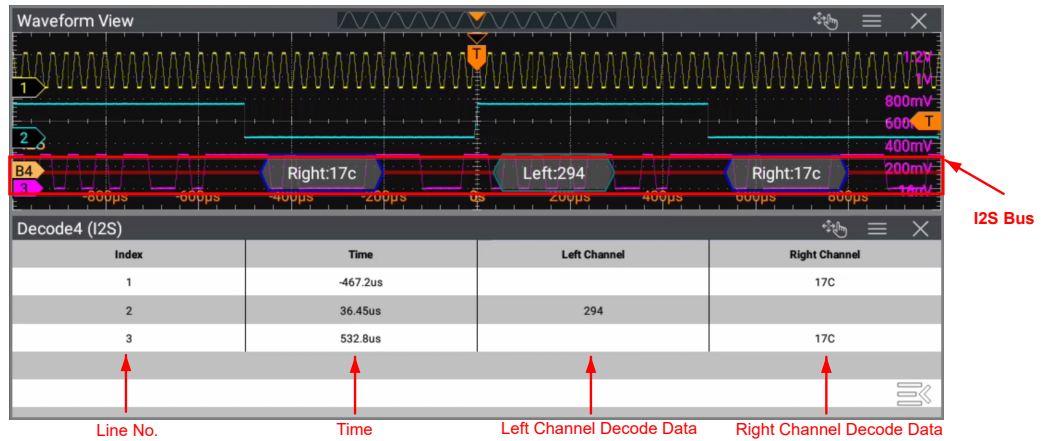

Figure 18.19 I2S Decoding Event Table

**TIP**

- When you adjust the horizontal time base, the waveform displayed on the screen will also change, and the total number of lines containing the decoding information in the event table will also be changed.
- The displayed decoded data information in the bus is related to the value of the horizontal time base. Reducing the horizontal time base can help you view the detailed information.

**Export**

When the operating status of the instrument is STOP, you can export the time and its corresponding decoding data from the current event table.

Click or tap **Export** to enter the file export interface. You can export the data list to the internal memory or the external USB storage device (only when detected) in \*.csv format. The detailed export operation is similar to the save operation, you can refer to relevant descriptions in *Store and Load*.

## 18.8 FlexRay Decoding (Option)

FlexRay is a type of differential serial bus configured with three consecutive segments (i.g. packet header, payload, and packet trailer). The oscilloscope samples the FlexRay signal, and judges each data point to be logic "1" or logic "0" according to the preset threshold level. The FlexRay decoding is required to specify the signal type and baud rate.

In the **Decode** menu, click or tap the drop-down button of **Bus Type** to select **FlexRay**, then configure the parameters for FlexRay decoding.

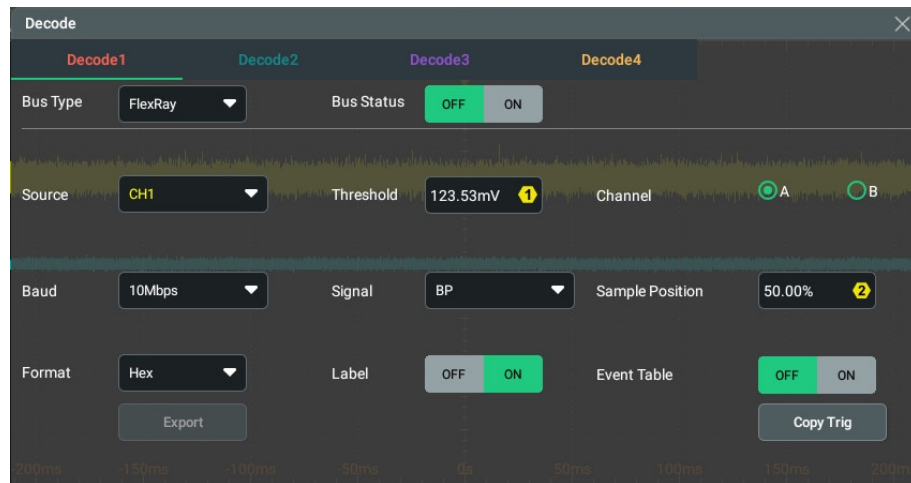

Figure 18.20 FlexRay Decoding Menu

### Bus Status

Click or tap the ON/OFF tab for **Bus Status** to enable or disable the bus decoding.

### Quickly Apply Trigger Settings to Decoding

Copy trig indicates applying the trigger settings to the specified decoding setting.

Click or tap **Copy Trig** to apply the trigger settings to the specified decoding setting.

## 18.8.1 Signal Configuration

### Set the Source and the Threshold

- The analog channel and the digital channel can all be set as the signal source. For the available channels of each model refer to *Content Conventions in this Manual*.
- When an analog channel is selected as the source, you can set the threshold for the specified channel with the pop-up numeric keypad. You can also use the specified multifunction knob to set the threshold.

When you modify the threshold of the signal source, a dotted line displaying the current threshold level is displayed on the screen. It disappears in about 2 s after you stop modifying the threshold.

### Select the Signal

Click or tap "A" or "B" in **Channel** to select a channel that matches the actual FlexRay bus signal.

### Specify the Signal Rate

Click or tap the drop-down button of **Baud** to select a FlexRay baud rate that matches the FlexRay bus signal. The available baud rates include "2.5 Mbps", "5 Mbps", and "10 Mbps".

### Set the Signal Type

Click or tap the drop-down button of **Signal** to select a signal type that matches the FlexRay bus signal. The available signal types include "BP", "BM", and "RX/TX".

### Sample Position

Sample position is a point within a bit's time. The oscilloscope samples the bit level at this point. The sample position is represented by the proportion of "the time from the start of the bit to the sample point" to the "bit time", as shown in the figure below.

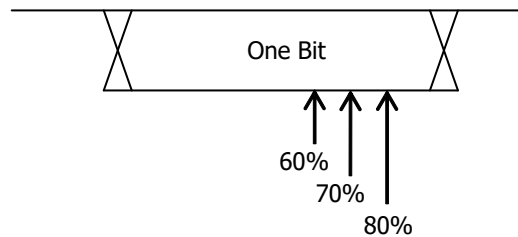

**Figure 18.21 Sample Position**

Click or tap the **Sample Position** input field and use the pop-up numeric keypad to set the value. You can also use the corresponding multifunction knob to set the value. The settable range is from 10% to 90%.

## 18.8.2 Display-related Settings

In **Decode** menu, set the following display-related parameters.

### Set the Display Format

Click or tap the drop-down button of **Format** to select the display format of the bus data and event table. The available options include "Hex", "Dec", "Bin", and "ASCII".

### Set the Label Display

Click or tap the **Label** on/off switch to enable or disable the label display of the decoding bus. When enabled, the bus label will be displayed at the upper-left side of the bus (when the bus display is enabled). The label shows the current bus type.

## 18.8.3 Event Table

When enabled the Event Table, the decoding event table is displayed on the screen. The decoding information of the signal is displayed in the event table window.

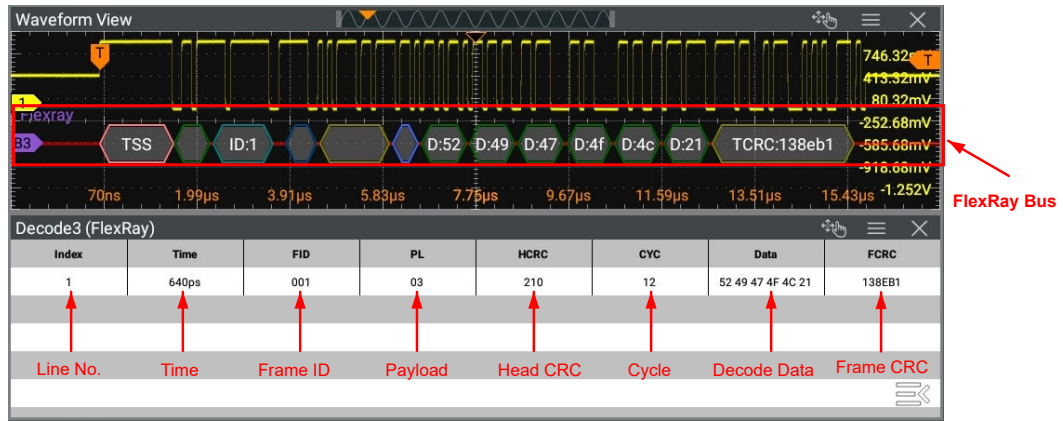

Figure 18.22 FlexRay Decoding Event Table



**TIP**

- When you adjust the horizontal time base, the waveform displayed on the screen will also change, and the total number of lines containing the decoding information in the event table will also be changed.
- The displayed decoded data information in the bus is related to the value of the horizontal time base. Reducing the horizontal time base can help you view the detailed information.

**Export**

When the operating status of the instrument is STOP, you can export the time and its corresponding decoding data from the current event table.

Click or tap **Export** to enter the file export interface. You can export the data list to the internal memory or the external USB storage device (only when detected) in \*.csv format. The detailed export operation is similar to the save operation, you can refer to relevant descriptions in *Store and Load*.

**Interpret the FlexRay Decoding Frame Structure**

- **TSS:** Transmission Start Sequence, identified as "TSS:".
- **Sync Frame:** identified as "SYNC:".
- **ID (Frame ID):** expressed in Hex, identified as "ID:".
- **PL (Payload Length):** expressed in Hex, identified as "PL:".
- **HCRC (Header Cyclic Redundancy Check):** expressed in Hex, identified as "HCRC:". When error occurs, it is displayed as a red patch.
- **CYC (Cycle Number):** expressed in Hex, identified as "CYC:".

- **Data:** its display format is the same as that of the bus data (Hex, Dec, Bin, or ASCII), identified as "Data:".
- **TCRC (Tail Cyclic Redundancy Check):** expressed in Hex, identified as "TCRC:".  
When error occurs, it is displayed as a red patch.

## 18.9 1553B Decoding (Option)

The oscilloscope samples the 1553B signal, and judges each data point to be logic "1" or logic "0" according to the preset threshold level. 1553B decoding is required to specify the data channel source and the threshold.

In the **Decode** menu, click or tap the drop-down button of **Bus Type** to select **1553B**, then configure the parameters for 1553B decoding.

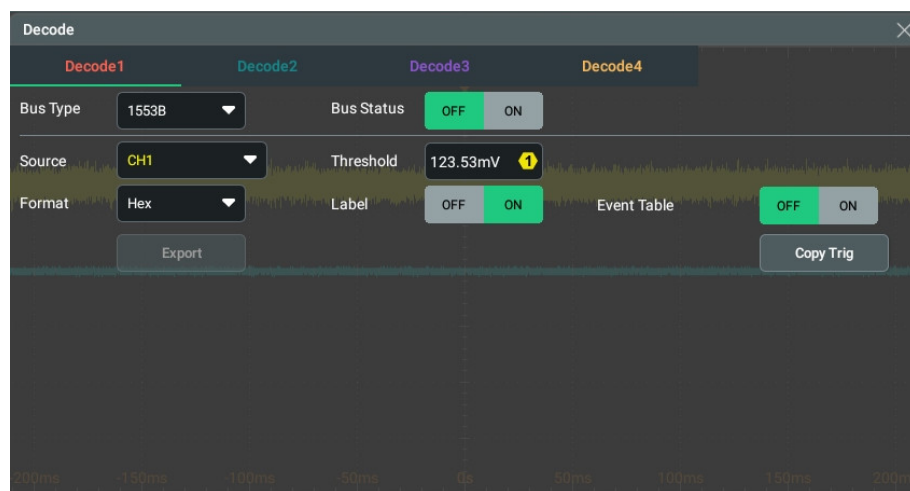

Figure 18.23 1553B Decoding Menu

### Bus Status

Click or tap the ON/OFF tab for **Bus Status** to enable or disable the bus decoding.

### Quickly Apply Trigger Settings to Decoding

Copy trig indicates applying the trigger settings to the specified decoding setting.

Click or tap **Copy Trig** to apply the trigger settings to the specified decoding setting.

### 18.9.1 Source Setting

#### Select the Data Channel

The analog channel or the digital channel can be set as the signal source. For the available channels of each model refer to *Content Conventions in this Manual*.

## Set the Threshold

When the analog channel is set as the data channel source, you can configure the **Threshold** for the specified channel with the pop-up numeric keypad. You can also use the specified multifunction knob to set the threshold.

When you modify the threshold of the channel, a dotted line displaying the current threshold level is displayed on the screen. It disappears in about 2 s after you stop modifying the threshold.

## 18.9.2 Event Table

When enabled the Event Table, the decoding event table is displayed on the screen. The decoding information of the signal is displayed in the event table window.

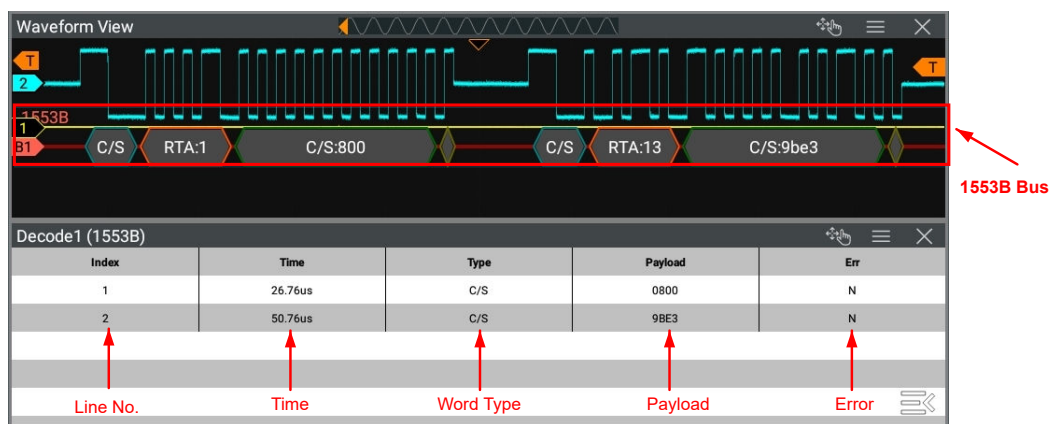

Figure 18.24 1553B Decoding Event Table



### TIP

- When you adjust the horizontal time base, the waveform displayed on the screen will also change, and the total number of lines containing the decoding information in the event table will also be changed.
- The displayed decoded data information in the bus is related to the value of the horizontal time base. Reducing the horizontal time base can help you view the detailed information.

### Export

When the operating status of the instrument is STOP, you can export the time and its corresponding decoding data from the current event table.

Click or tap **Export** to enter the file export interface. You can export the data list to the internal memory or the external USB storage device (only when detected) in \*.csv format. The detailed export operation is similar to the save operation, you can refer to relevant descriptions in *Store and Load*.

### Interpret the 1553B Decoding Frame Structure

- **C/S:** command/status word, identified as "C/S".
- **RTA:** remote terminal address of the command/status word, identified as "RTA:".
- **C/S Data:** the rest data value of the command/status word. Its display format is the same as that of the bus data (Hex, Dec, Bin, or ASCII), identified as "C/S:".
- **Parity bit:** displayed as a yellow-green patch; when errors occur, it is displayed as a red patch.
- **Data word data:** data of the data word. Its display format is the same as that of the bus data (Hex, Dec, Bin, or ASCII), identified as "Data:".

## 19 Multi-pane Windowing

This oscilloscope supports multi-pane windowing. You can add multiple windows and result display windows for display and view.

Click or tap  > **Windows** to enter the "Add Window" menu. You can also click or tap the **Windows** icon on the toolbar menu. The "Add Window" menu is as shown in the figure below.

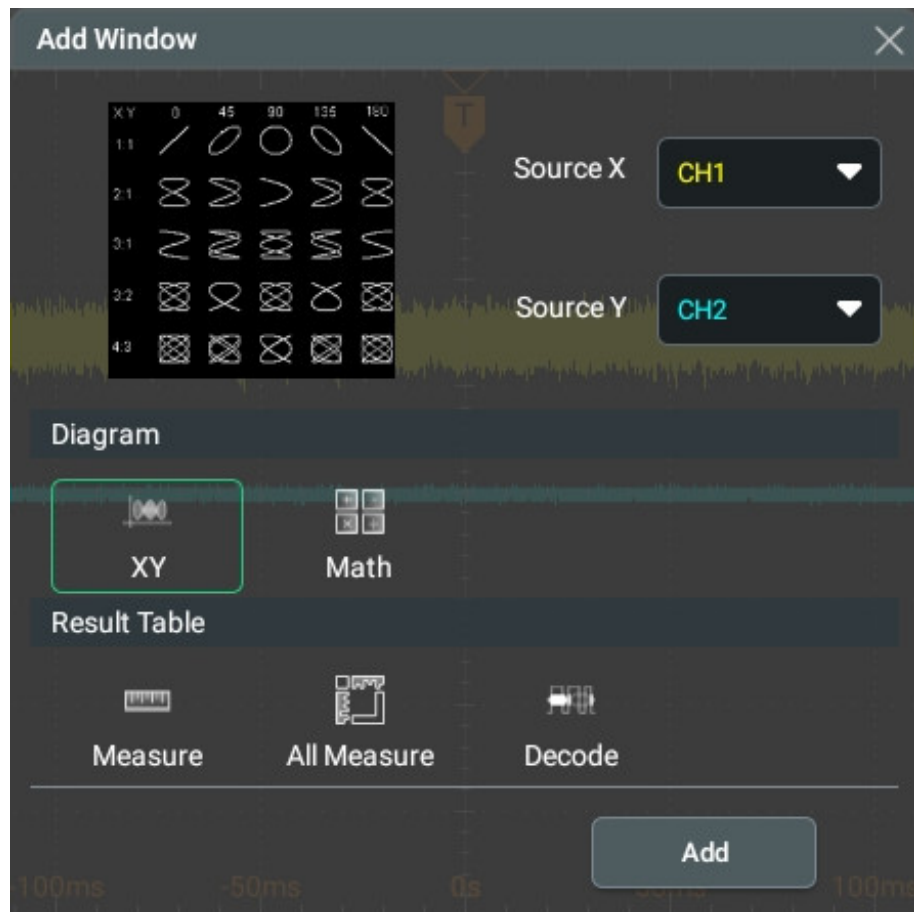

Figure 19.1 Add Window Menu

### Add Diagram Windows

1. First, select "XY" or "Math" in **Diagram**. When a diagram is selected, its preview and parameter setting items can be displayed at the upper part of the "Add Window" menu.
2. You can set the corresponding parameters according to your needs. For details, refer to descriptions of relevant chapters.
3. Click or tap **Add** and then the selected diagram is displayed on the screen.

**TIP**

When the waveform view window is closed, the "Waveform View" item appears on the **Diagram** menu. You can use the item to open the waveform view window.



**Add Result Table Window**

Click or tap "**Measure**", "**All Measure**", or "**Decode**" in **Result Table**, and then click or tap **Add**. The corresponding measurement results will be displayed on the screen.

## 20 Waveform Recording and Playing

Waveform recording/playing function can play the recorded waveforms, enabling you to analyze the waveforms better.

You can enter the "Record" menu in the following ways.

- Click or tap the function navigation icon  and then select **Record** to enter the "Record" menu.
- Click or tap **Record** on the toolbar to enter the "Record" menu.
- Press the front-panel  key and select **Record** in the pop-up "Analyse" menu to enter the "Record" menu.

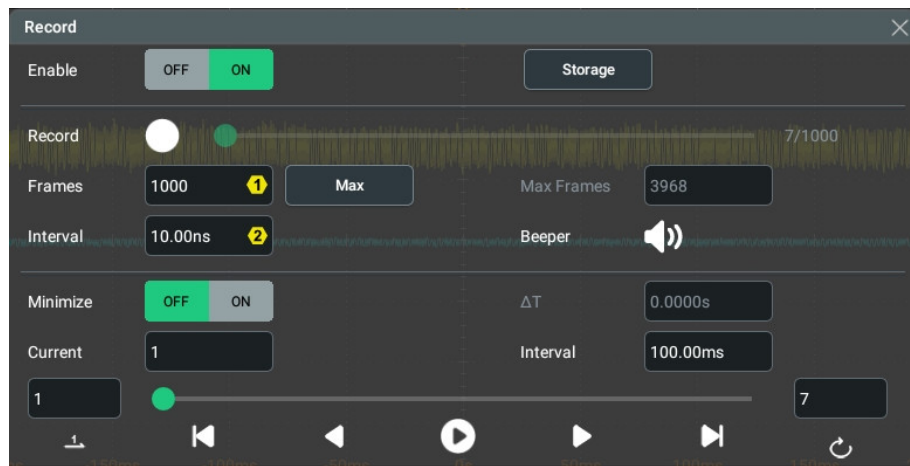





Figure 20.1 "Record" Menu



### 20.1 Common Settings

#### Recording Operation

Click or tap the ON/OFF tab for the **Enable** menu in the Record & Play interface to enable or disable the waveform recording and playing function. Before recording the waveform, you can refer to descriptions in *Record Options* to set the waveform recording parameters.



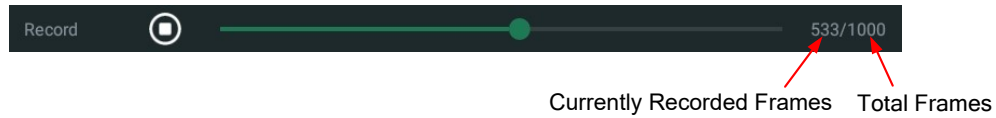

- Click or tap the **Record** icon  to start recording the waveforms. Then the record icon turns from  to .
- The data at the right side of the recording progress bar shows the number of currently recorded frames and the total number of frames that can be recorded (Number of Currently Recorded Frames/Total Number of Frames that can be Recorded). During the recording, the current recording information updates in a

real-time manner on the screen, and the number of currently recorded frames changes constantly.

- After the recording is completed,  turns out to be  and recording stops automatically.
- During recording, you can also click or tap  to suspend recording manually.



### Play Operation

Click or tap the play icon  in the **Play** menu to start to play the recorded waveforms. The play icon turns from  to the pause action icon . For details about playing, refer to descriptions in *Play Options*. During waveform playing, the value of **Current** changes dynamically. During playing, you can also click or tap the icon  again to suspend playing manually.  $\Delta T$  indicates the time interval between the current frame played and the first frame.

### Minimize

Click or tap the **Minimize** on/off switch to select whether to minimize the menu. When ON is selected, the window is minimized, making the display more simplified, easy for observation and operation. The default minimized window is the record window. Click or tap **Record** to switch to the **play** minimized window. The minimized record/play window is displayed on the right side of the screen as shown in the following figure.



**Figure 20.2 Minimized Window of the Record Operation Interface**

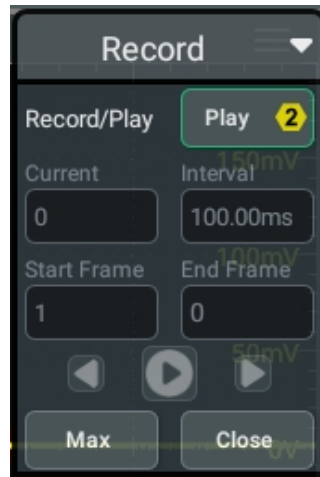

Figure 20.3 Minimized Window of the Play Operation Interface

### Storage

Click or tap **Storage**, then it goes to the storage interface. For the detailed operation, refer to descriptions in *To Save the Wave* to save the recorded waveforms based on the settings.

## 20.2 Record Options

During the waveform recording, the oscilloscope records the waveforms of the currently enabled channel at a specified interval until you manually stops the recording operation or the number of recorded frames has reached the limit.

Before recording the waveforms, set the following parameters.

### 1. Interval

The recording interval indicates the time interval between the frames during the recording process.

Click or tap the **Interval** input field and use the pop-up numeric keypad to set the time interval between frames. You can also use the front-panel multifunction knob to set the value. The available range is from 10 ns to 1 s.

### 2. Frames

The recording frames refer to the number of frames that can be recorded actually. After starting the recording operation, the oscilloscope stops the recording operation automatically when the number of recorded frames reaches the set value.

Click or tap the **Frames** input field to set the number of waveform frames to be recorded currently. You can also use the front-panel multifunction knob to set the value. The range available is from 1 to the maximum number of frames that can be recorded currently.

### 3. Max Frames

The input field of **Max Frames** displays the maximum number of frames that can be recorded currently. Click or tap **Max** and the frames will be automatically set to the maximum value.

As the waveform memory is fixed, the more points in each frame, the fewer waveform frames that can be recorded. Therefore, the maximum number of recorded frames depends on currently selected "memory depth" (refer to *memory depth*). The number of waveform points per frame is the current memory depth.  $\text{Memory Depth} \geq \text{Sample Rate} \times \text{Horizontal Time Base} \times \text{Number of Grids in the Horizontal Direction}$ . Therefore, the Max. value of waveform recording is also related to the "Sample Rate" and "Horizontal Time Base".

### 4. Beeper



: the beeper sounds at the end of recording.



: the beeper does not sound at the end of recording.

## 20.3 Play Options



Waveform playing function can play back the waveforms currently recorded. In **Play**, click or tap the **Minimize** on/off switch to select whether to minimize the menu. When **ON** is selected, the window is minimized, making the display more simplified, easy for observation and operation.





**Figure 20.4 Minimized Window of the Play Operation Interface**



Before playing the waveforms, set the following parameters.



## 1. Play Mode

Plays the waveforms in single mode () or cycle mode (). Click or tap the first icon at the bottom of the Play option menu to switch the play mode.

- : plays from the start frame to the end frame, and then stops automatically.
- : plays from the start frame to the end frame, then such playback operation is repeated until you stop it manually.

## 2. Playback Sequence

Plays back the waveforms clockwise () or counterclockwise (). Click or tap the last icon at the bottom of the Play option menu to switch the playback sequence.

- : plays from the start frame to the end frame.
- : plays from the end frame to the start frame.

## 3. Interval

Indicates the time interval between the frames during the playing process.

Click or tap the input field of **Interval**, and then use the pop-up numeric keypad to set the time interval between frames. You can also use the corresponding multifunction knob to set the value. The available range is from 1 ms to 1 s.

## 4. Start Frame

Click or tap the input field of "Start Frame" to set the start frame to be played back with the pop-up numeric keypad. You can also rotate the specified multifunction knob indicated in the input field to set the value. The default is 1, and the maximum value is the maximum number of waveform frames that have been recorded.

## 5. End Frame

Click or tap the input field of "End Frame" to set the end frame to be played back with the pop-up numeric keypad. You can also rotate the specified multifunction knob indicated in the input field to set the value. The default value is the number of waveform frames that have been recorded.

## 6. Current Frame

When the playing is stopped, click or tap the "Current" input field to set the currently displayed frame with the pop-up numeric keypad. You can also use the

corresponding numeric keypad to set the value. The max. value for the current frame is the max. number of frames that have been recorded.

## 21 Search and Navigation

The search function can help you quickly locate the concerned events and make a mark. Then, you can use the specific navigation arrow keys to quickly locate the specified event. The search type can be set to Edge or Pulse.

The navigation function guides users to quickly locate and view the specified waveforms. You can navigate by time and event.

### 21.1 Search

The search function allows you to search the specified Edge or Pulse event, then marks it with an upside-down triangle icon (▼).

To enter the Search menu, perform any of the following operations:

- Click or tap the function navigation icon  at the lower-left corner of the screen to enter the function navigation.
- Click or tap **Search** to enter the search menu.

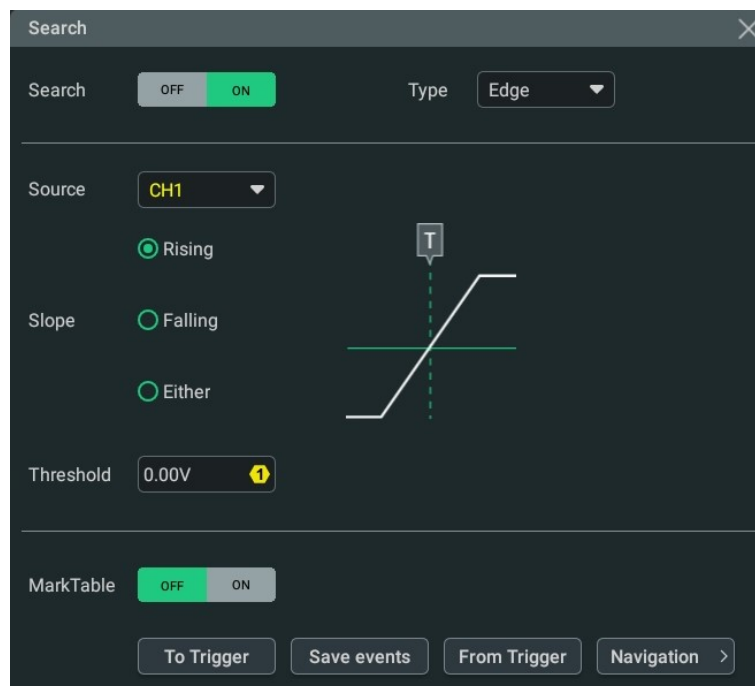

Figure 21.1 Search Menu

#### Search On/Off

Click or tap **Search** on/off switch to enable or disable the search function.

**TIP**

Enabling the search function automatically turns on the *Zoom Mode (Delayed Sweep)*.

**Select the Search Type**

Select "Edge" or "Pulse" as the search type.

- **Edge search:** After selecting "Edge" as the search type, set the edge type and threshold. For detailed setting methods, refer to *Edge Trigger*.
- **Pulse search:** After selecting "Pulse" as the search type, set the pulse polarity, search condition, and threshold. For detailed setting methods, refer to *Pulse Width Trigger*.

**Set the Source**

Select an analog channel as the source of the search function. For the available channels of each model refer to *Content Conventions in this Manual*.

**Copy Trigger**

- **Copy to Trigger**

Click or tap **To Trigger** to copy the setup for the selected search type to the same trigger type. For example, if the current search type is "Edge", clicking or tapping **To Trigger** copies the search settings to the *Edge Trigger* settings.

- **Copy from Trigger**

Click or tap **From Trigger** to copy the trigger setup for the selected search type to the search setup. For example, if the current trigger type is *Edge Trigger*, click or tap **From Trigger** to copy the Edge trigger settings to the "Edge" search settings.



**NOTE**

If you select "From Trigger" or "To Trigger", you need to set the search type first, and then copy the trigger type settings from the trigger menu.

**Enable or Disable the Marker Table**

When the marker table is enabled, the marker table is displayed, as shown in the figure below. The table lists all events of the current waveform in the Waveform View. Zooming or adjusting the waveform causes the events in the table to change. You can perform the following operations on the table:

- When acquisitions are stopped (STOP mode), click or tap any row of the table to select the specified event. The inverted triangle mark of the selected event turns red like .

- Click or tap  at the upper-right side of the table to open the search menu.
- Select the gray title bar of the table to drag the table and move the table window.
- Click or tap  at the upper-right side of the table to close the search menu.

Search			
Index	Time	EventCount	Info
1	-50us	1	Rising edge
2	-49.59us	1	Rising edge
3	-48.79us	1	Rising edge
4	-47.99us	1	Rising edge
5	-47.19us	1	Rising edge
6	-46.39us	1	Rising edge
7	-45.59us	1	Rising edge
8	-44.79us	1	Rising edge
9	-43.99us	1	Rising edge
10	-43.19us	1	Rising edge

Figure 21.2 MarkTable Display

### Navigation

Click or tap **Navigation** to access the navigation menu. You can use the "Search Event" mode in *Navigation* to navigate through the search events.

### Save search events

You can save the event data to the instrument's internal memory or an external USB storage device in format of "\*.csv".

Click or tap **Save events** to access the "Save" menu. Please refer to descriptions in *To Save a File* to save the event marker data to the internal or external memory.

## 21.2 Navigation

The navigation function includes the time navigation and search event navigation. You can access the **Navigation** menu in the following ways.

- Press the front-panel  key to access the menu.
- Click or tap **Navigate** on the toolbar at the upper-right of the interface.
- In the "Search" menu, click or tap **Navigation** to access the menu.

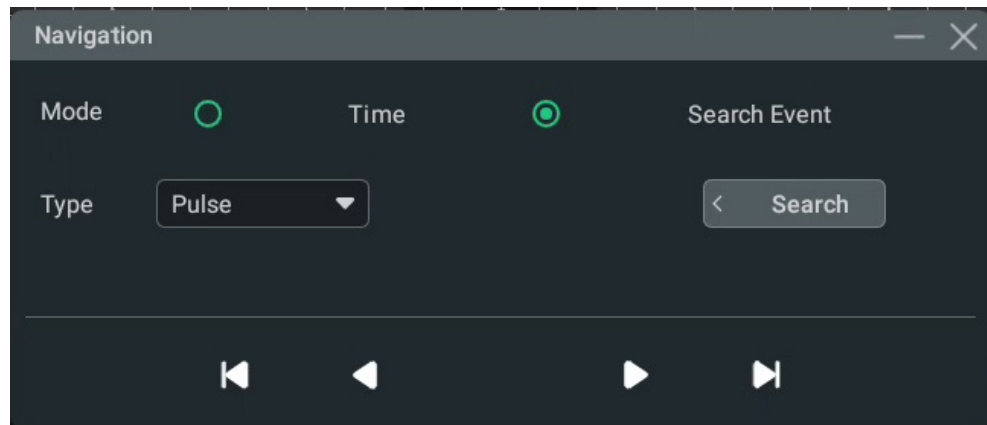

**Figure 21.3 Navigation Menu**

Clicking or tapping the icon  can minimize the Navigation window, making the interface simple and clear, as shown in the figure below.

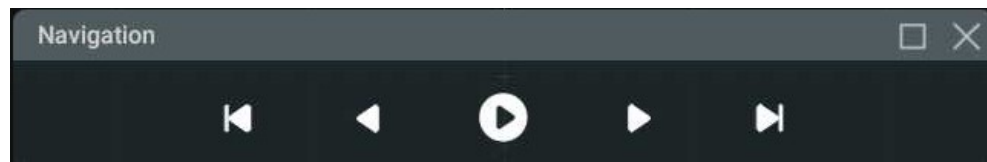

**Figure 21.4 Simplified Navigation Menu**



### Notice





The navigation function is available only when the oscilloscope is in "STOP" state (acquisition stopped).

### Time Navigation

After stopping data acquisition, use the navigation control buttons in the Navigation interface to play forward and backward the captured waveforms. You can also use the

navigation combination keys    on the horizontal control area on the front panel to control the waveforms.

- After selecting time navigation, click or tap  to start to play the waveforms.
- During the play, click or tap  to play backward, then stops automatically until it plays back to the start; click or tap  to play forward, then stops automatically until it reaches the end.

- When it stopped playing, click or tap  or  to move backward or forward the waveforms.
- Click or tap  to go to the start segment of the waveforms to be played. Click or tap  to go to the last segment of the waveforms to be played.

Click or tap the **Speed** drop-down button to select the speed level.

### Search Event Navigation



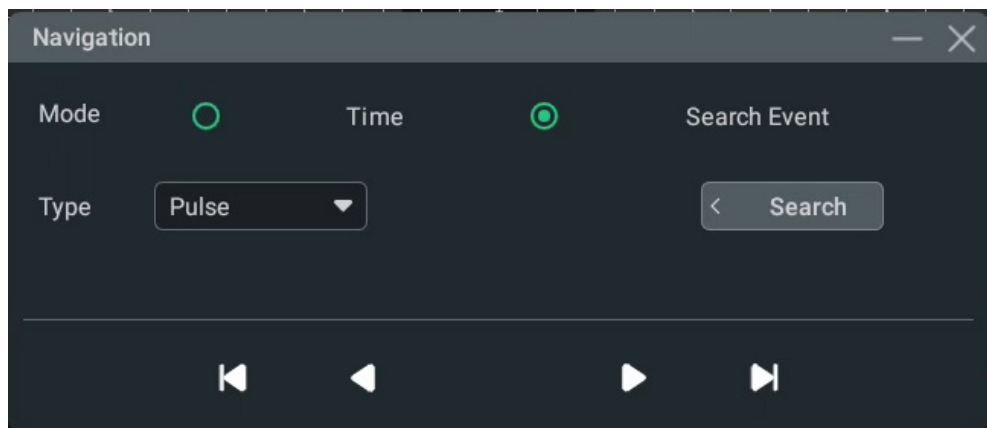

When you enable the navigation function and complete the event search, you can use the navigation combination keys to quickly navigate the specific event in the event mark table.



**Figure 21.5 Search Event Navigation Interface**

After selecting the **Search Event** navigation, click or tap **Search** to set the search conditions.

The search event type can be set to "Edge" or "Pulse", which shall be consistent with the search type specified in **Search** menu.

Click or tap  to go to the previous search event or  to go to the next search event. Click or tap  to go to the first event or  to go to the last event.

## 22 Display Control

In the **Display** setting menu, you can set the type, persistence time, waveform intensity, grid type, grid brightness, and etc. Click or tap the function navigation icon



at the lower-left corner of the screen, and then select **Display** to enter the

"Display" menu. You can also click or tap the icon at the upper-right of the Waveform View to enter the "Display" menu.

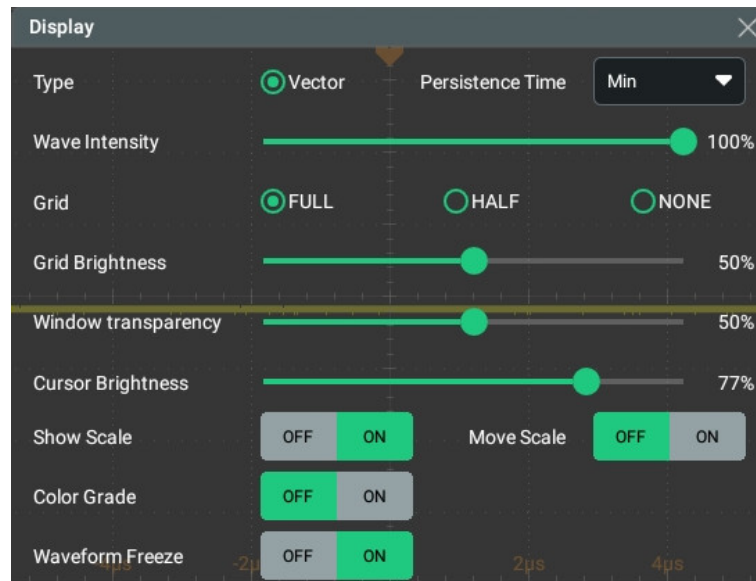

Figure 22.1 Display Setting Menu

### 22.1 Display Type

This series oscilloscope provides the "Vector" display mode in which the sample points are connected by lines and displayed. In most cases, this mode can provide the most vivid waveform for you to view the steep edge of the waveform (such as square waveform).

### 22.2 Persistence Time

In the **Display** setting menu, click or tap the drop-down button of **Persistence Time** to select the persistence time. The available values are Min, specific values (100 ms, 200 ms, 500 ms, 1 s, 2 s, 5 s, 10 s), and Infinite.

In the following part, a frequency sweep signal of the sine waveform is used to show the waveform effects in different persistence times.

- **Min**

Enables you to view waveform changing in high refresh rate.

- **Specific Values**

Enables you to view glitches that change relatively slowly or glitches with lower occurrence probability. The persistence time can be set to 100 ms, 200 ms, 500 ms, 1 s, 2 s, 5 s, or 10 s.

- **Infinite**

In this mode, the oscilloscope displays the waveform newly acquired without clearing the waveforms acquired formerly. The waveforms acquired formerly will be displayed in relatively low-brightness color and the newly acquired waveforms will be displayed in normal brightness and color. Infinite persistence can be used to measure noise and jitter and to capture incidental events.

## 22.3 Waveform Intensity

In **Display** menu, drag the slide bar of **Wave Intensity** to set the brightness of waveforms. The default is 50%, and the range available is from 1% to 100%.

## 22.4 To Set the Screen Grid

In the **Display** menu, select "FULL", "HALF", or "NONE" in **Grid**.



- **FULL:** turns the background grid on.
- **HALF:** turns part of the grid off, leaving only the main grid.
- **NONE:** turns the background grid off.

## 22.5 Display Settings

### Grid Brightness

In the **Display** setting menu, drag the slider of **Grid Brightness** to set the grid brightness. The default is 50%, and the range available is from 0% to 100%.

### Window Transparency

In the **Display** setting menu, drag the slider of **Window Transparency** to set the window transparency. The default is 50%, and the range available is from 0% to 100%.

### Cursor Brightness

In the **Display** setting menu, drag the slider of **Cursor Brightness** to set the cursor brightness. The default is 80%, and the range available is from 0% to 100%.

## 22.6 Show Scale

In the "Display" setting menu, click or tap the **Show Scale** ON/OFF switch to enable or disable the scale display on the screen. By default, it is ON.

Click or tap the **Move Scale** ON/OFF switch to control the relative motion between the scale and the waveform. When enabled, the scale tracks the waveform and the scale reading remains constant, making it easier to align with reference lines. When disabled, the scale remains fixed and the scale reading updates as the waveform moves. By default, it is OFF.

## 22.7 Color Grade

In the **Display** setting menu, click or tap the **Color Grade** on/off switch to enable or disable the color grade display. By default, it is OFF.

When it is enabled, different colors are displayed on the screen to indicate the times of data acquisition or acquisition probability.

## 22.8 Waveform Freeze

In the **Display** setting menu, click or tap the **Waveform Freeze** on/off switch to enable or disable the waveform freeze function. By default, it is ON.

When the function is enabled, the oscilloscope freezes and holds the last waveform on the display after sampling is stopped when you click or tap the **STOP/RUN** button

at the upper-right side of the screen or press the front-panel  key. If this function is disabled, the last acquired waveform is displayed.

## 23 Store and Load

---

You can save the setups, waveforms, screen image, and parameters of the current oscilloscope to the internal memory, an external USB storage device (such as USB flash drive), or an SMB shared folder in various formats and recall the stored setups or waveforms when necessary. You can also load the upgrade software to the system and perform the upgrade operation for the instrument.

You can also copy, delete, or rename the specified type of file from the internal memory, the external USB storage device, or the shared folder via the disk management menu.

This oscilloscope provides one USB HOST interface on the front panel, which can be connected to the USB storage device for external storage. The USB storage device connected is marked as "Removable USB Disk (D)".

### 23.1 To Enter the Storage Menu

---

You can enter the storage setting menu in the following ways.

- Click or tap the function navigation icon  at the lower-left corner of the screen, and then select **Storage** to enter the storage setting menu.
- Click or tap the **Storage** button on the toolbar to enter the storage setting menu.

In the **Storage** setting menu, there are three sub-menus (Save, Load, and Upgrade) for you to choose. Select the specified sub-menu and configure the corresponding parameters.

### 23.2 To Save a File

---

In the **Storage** menu, click or tap the **Save** tab to enter the save setting menu. In this menu, you can save the image, waveform, or setup files.

#### 23.2.1 To Save the Image

---

In the **Storage** menu, click or tap the **Save** tab to enter the save operation menu. In this menu, click or tap the drop-down button of **Choose** to select **Save Image** to enter the "Save Image" setting menu. Set the relevant parameters and save the image to the internal or external memory.

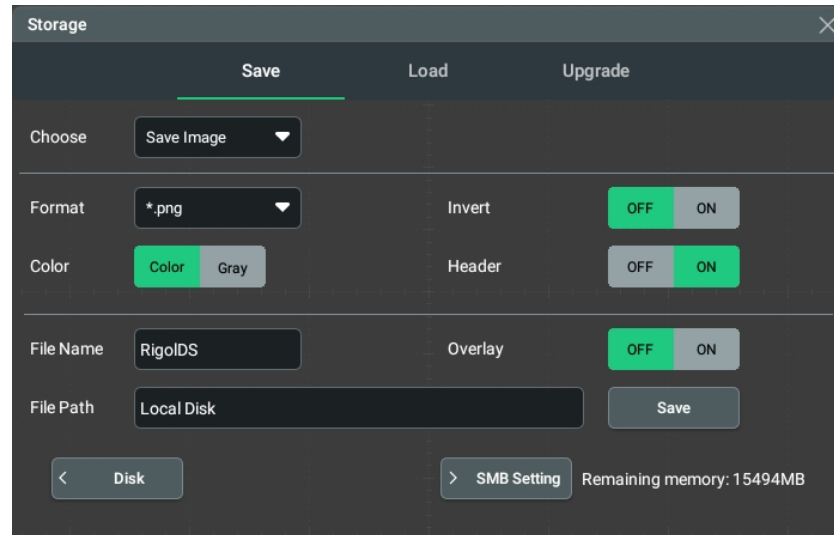

Figure 23.1 Image Saving Setting Menu

### Set the image format

- **Format:**

Click or tap the drop-down button of **Format** to select **".png"**, **".bmp"**, or **".jpg"** from the drop-down list. Then the screen image will be saved to the internal or external memory in **".png"**, **".bmp"**, or **".jpg"** format.

- **Invert:**

Click or tap the ON/OFF button for the **Invert** menu to enable or disable the image invert function.

- **Color:**

Click or tap **"Color"** or **"Gray"** for **Color** to select the desired storage color.

- **Header:**

Click or tap the ON/OFF tab for the **Header** menu to enable or disable the display of the header. If you select **"ON"**, the instrument model and the image creation date will be displayed in the header of the image when you save the image file.

### Set the File Saving Parameters

- **Set the filename**

Click or tap the input field of **File Name** to input the file name to be saved with the pop-up virtual keypad.

- **Set the file path**

Click or tap the input field of **File Path**, then the disk management interface is displayed. In the disk management interface, select the destination storage path, then click or tap **OK** to set the storage path for the saved file. For detailed operations, refer to descriptions in *Disk Management*.

The default file path is "Local Disk". When a USB device is detected, the path is automatically set to "D:". When a shared folder is connected, the path is automatically set to "I:".

- **Overlay**

Click or tap the ON/OFF button for the **Overlay** menu to enable or disable the overwriting function. When enabled, the existing file in the specified file path will be overwritten by the newly saved file that has the same filename as the existing one.

Click or tap **Save**, the screen image is saved based on the current settings and the storage menu is closed.

**TIP**

When the quick action function is set to "Save Image" or "Save Group" with "Save Image" selected, you can press the front-panel  key to save the image.



## 23.2.2 To Save the Wave

In the **Storage** menu, click or tap the **Save** tab to enter the save operation menu. In this menu, click or tap the drop-down button of **Choose** to select "**Save Wave**" to enter the "Save Wave" setting menu. The main settings (e.g. channel on/off state, vertical scale, and horizontal time base) and waveform data of all enabled channel will be saved to the internal or external memory.

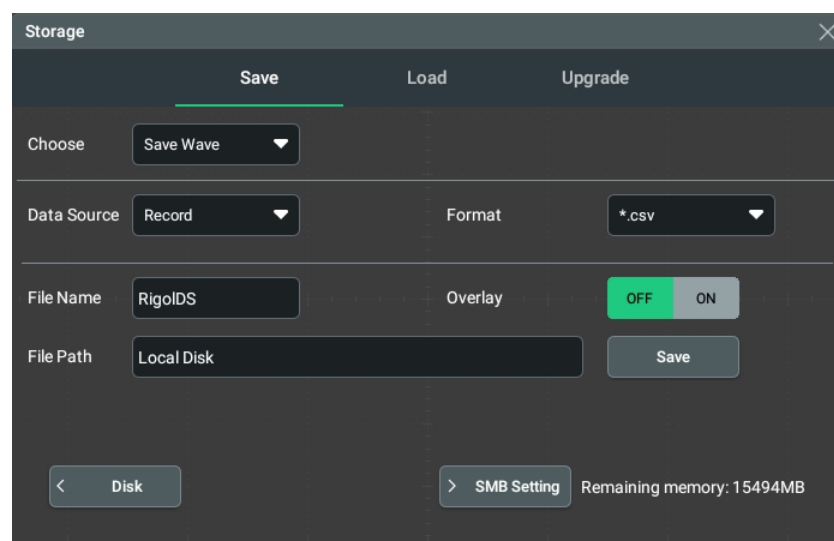

**Figure 23.2 Waveform Saving Setting Menu**

### Set the Source of the Waveform Data

The available sources of the waveform data are as follows:

- **Screen:** waveforms displayed on the screen.
- **Memory:** waveforms from the memory.
- **Record:** waveforms that have been recorded. For details about the recorded waveforms, refer to *Waveform Recording and Playing*.

### Waveform format

The available formats of the waveform data are as follows:

- When the data source is "Screen", the available formats are "\*.bin" or "\*.csv";
- When the data source is "Memory", the available formats are "\*.bin", "\*.csv" or "\*.wfm";
- When the data source is "Record", the available format is "\*.csv".



#### TIP

Refer to *Quick Operation*. When the quick action function is set to "Save Wave", or set to "Save Group" with "Save Wave" being selected, you can press the front-panel quick operation key



to save the waveform.

## 23.2.3 To Save the Setup

In the **Storage** menu, click or tap the **Save** tab to enter the save operation menu. In this menu, click or tap the drop-down button of **Choose** to select "**Save Setup**" to enter the "Save Setup" setting menu. Save the settings of the oscilloscope to the internal or external memory in "\*.stp" format. When loading, the stored settings can be recalled.

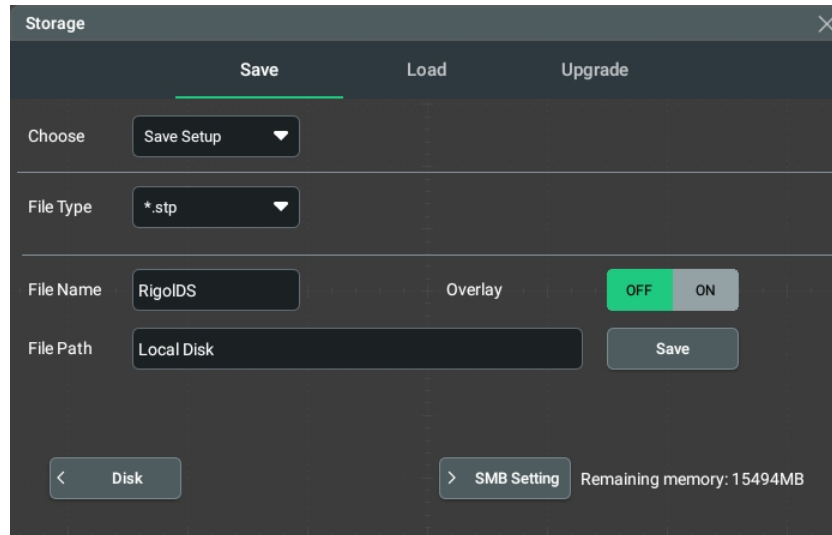

Figure 23.3 Setup Saving Setting Menu

### Set the File Saving Parameters

- **Set the filename**

Click or tap the input field of **File Name** to input the file name to be saved with the pop-up virtual keypad.

- **Set the file path**

Click or tap the input field of **File Path**, then the disk management interface is displayed. In the disk management interface, select the destination storage path, then click or tap **OK** to set the storage path for the saved file. For detailed operations, refer to descriptions in *Disk Management*.

The default file path is "Local Disk". When a USB device is detected, the path is automatically set to "D:". When a shared folder is connected, the path is automatically set to "I:".

- **Overlay**

Click or tap the ON/OFF button for the **Overlay** menu to enable or disable the overwriting function. When enabled, the existing file in the specified file path will be overwritten by the newly saved file that has the same filename as the existing one.

Click or tap **Save** to save the setup file based on the current settings and the storage menu is closed.

#### TIP

When the quick action function is set to "Save Setup" or "Save Group" with "Save Setup"

selected, you can press the front-panel  key to save the setup.



## 23.2.4 Binary Data Format (.bin)

Binary data format stores waveform data in binary format and provides data headers that describe these data. As data are displayed in binary format, its file size is much more smaller than that in ASCII format. If several channels are enabled, then all the displayed channels will be saved (save the first channel then save the second, and then it goes on like this until all the displayed channels are saved).

**Table 23.1 BIN File Format**

File Header	Waveform Header	Waveform Data Header	Channel Data	Waveform Header	Waveform Data Header	Channel Data
16 Bytes	140 Bytes	16 Bytes	n Bytes	140 Bytes	16 Bytes	n Bytes

In BIN file format, it contains the following channel data:

- CH1 Data
- CH2 Data
- CH3 Data
- CH4 Data
- Digital Waveform Data

### Binary Header Format

#### 1. File Header

There is only one file header in a binary file. The file header contains the following information.

**Table 23.2 File Header**

Cookie	Two-byte characters, RG, indicating that the file is the RIGOL binary data file format.
Version	Two-byte, indicating the file version.
File Size	An 8-byte long integer, indicating the number of bytes in the file. It includes the header.
Number of Waveforms	A 4-byte integer, indicating the number of waveforms that are stored in the file.

#### 2. Waveform Header

It is possible to store several waveforms in the file. Each stored waveform has a waveform header. When several channels are stored, each channel can be considered as a separate waveform. The waveform header contains the information about the type of waveform data that are stored following the waveform data header.

**Table 23.3 Waveform Header**

Header Size	A 4-byte integer, indicating the number of bytes in the header.
Waveform Type	A 4-byte integer, indicating the type of the waveform stored in the file. It is fixed to 1. <ul style="list-style-type: none"> <li>- 0 = Unknown</li> <li>- 1 = Normal</li> <li>- 2 = Peak Detection</li> <li>- 3 = Average</li> <li>- 4 = Not Used</li> <li>- 5 = Not Used</li> <li>- 6 = Logic</li> </ul>
Number of Waveform Buffers	A 4-byte integer, indicating the number of waveform buffers required to read the data. It is fixed to 1.
Number of Points	A 4-byte integer, indicating the number of waveform points in the data.
Count	A 4-byte integer. It is fixed to 0.
X Display Range	A 4-byte float, indicating the X-axis duration of the waveform that is displayed. For time-domain waveforms, it indicates the duration of the display. If the value is zero, then no data has been acquired.
X Display Origin	An 8-byte double-precision floating-point, indicating the X-axis value at the left edge of the screen. For time-domain waveforms, it indicates the time at the start of the display. The value is treated as a double precision 64-bit float point number. If the value is zero, then no data has been acquired.
X Increment	An 8-byte double-precision floating-point, indicating the duration between data points on the X-axis. For time-domain waveforms, it indicates the time between points. If the value is zero, then no data has been acquired.
X Origin	An 8-byte double-precision floating-point, indicating the X-axis value of the first data point in the data recording. For time-domain waveforms, it indicates the time of the first

	point. The value is treated as a double precision 64-bit float point number. If the value is zero, then no data has been acquired.
X Units	A 4-byte integer, indicating the unit of measurement for X values in the acquired data. It is fixed to 2. <ul style="list-style-type: none"> <li>- 0 = Unknown</li> <li>- 1 = Volts (V)</li> <li>- 2 = Seconds (s)</li> <li>- 3 = Constant</li> <li>- 4 = Amps (A)</li> <li>- 5 = Decibel (dB)</li> <li>- 6 = Hertz (Hz)</li> </ul>
Y Units	A 4-byte integer, indicating the unit of measurement for Y values in the acquired data. The possible values are listed above under X Units.
Date	A 16-byte character array, indicating the date when the file is saved.
Time	A 16-byte character array, indicating the time when the file is saved.
Model	A 24-byte character array in the format of MODEL#:SERIAL#, indicating the oscilloscope's model and serial number.
Channel Name	A 16-byte character array that contains the label assigned to the waveform.

### 3. Waveform Data Header

A waveform may have multiple data sets. Each waveform data set has a waveform data header. The waveform data header consists of information about the waveform data set. The header is stored before the data set.

**Table 23.4 Waveform Data Header**

Header Size	A 4-byte integer, indicating the number of bytes in the waveform data header.
Buffer Type	A 2-byte integer, indicating the type of the waveform data stored in the file. <ul style="list-style-type: none"> <li>- 0 = Unknown</li> <li>- 1 = Normal 32-bit float data</li> <li>- 2 = Maximum float data</li> <li>- 3 = Minimum float data</li> </ul>

	<ul style="list-style-type: none"> <li>- 4 = Not Used</li> <li>- 5 = Digital unsigned 8-bit character data (for digital channels)</li> </ul>
Bytes Per Point	A 2-byte short integer, indicating the number of bytes per data point.
Buffer Size	An 8-byte long integer, indicating the number of bytes of the current channel waveform data.

## 23.3 To Load a File

In the storage setting menu, click or tap the **Load** tab to switch to the load menu. In this menu, you can load the local file to the instrument.

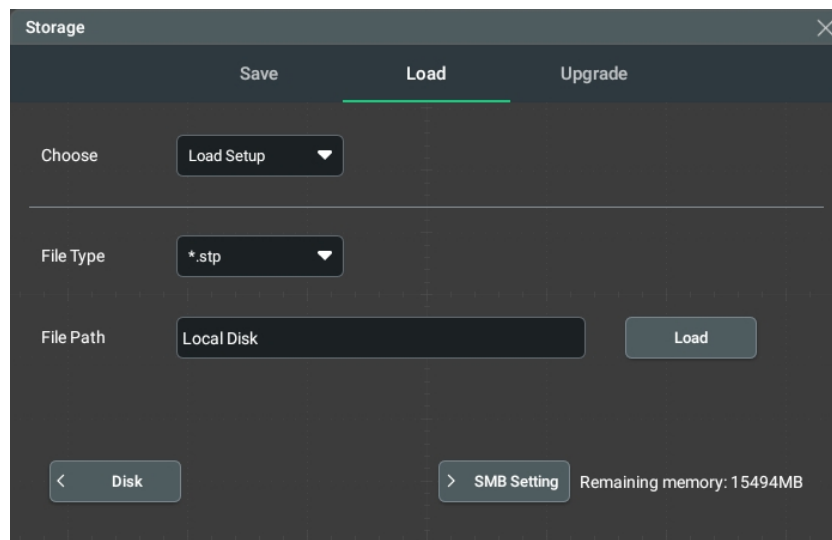

Figure 23.4 Load Setting Menu

### Load Setup

Click or tap the drop-down button of **Choose** to select "Load Setup". Then, click or tap **File Path** to select the internal memory (C:), external USB device (D:), or shared folder (I:) to load the settings. The default file type is "\*.stp", and no other options are available. Select the file to be loaded from the memory. Click or tap **Load** to load the selected file.

## 23.4 Firmware Upgrade

This instrument supports local upgrade and online upgrade.

## Local upgrade

1. In the storage setting menu, click or tap **Upgrade** to enter the local upgrade setting menu.

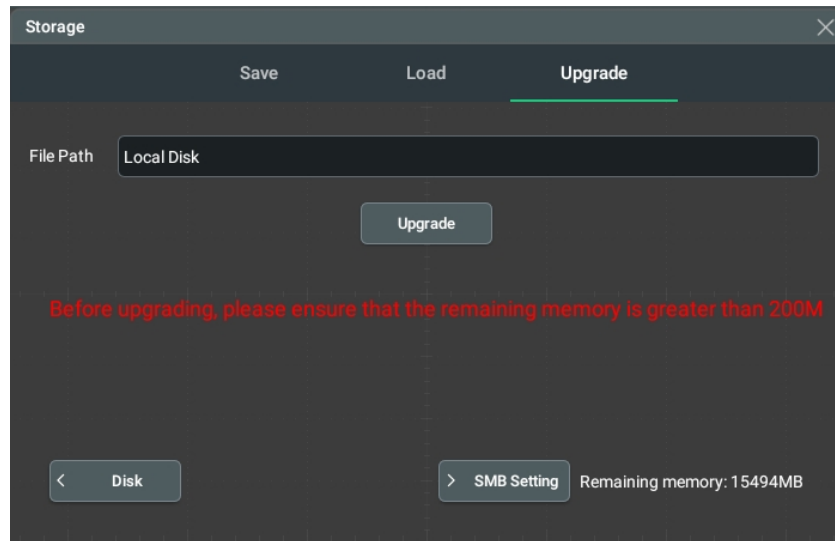



Figure 23.5 Upgrade Menu

2. Click or tap the input field of **File Path**, then the disk management interface is displayed. Select the upgrade file. For detailed operations, refer to *Disk Management*.
3. Click or tap **Upgrade** to complete the local upgrade.

## Online upgrade

1. First ensure that the rear-panel LAN interface is connected to the network (if you have limited access to the Internet, please ask the administrator for permission).
2. Click or tap the function navigation icon  at the lower-left corner of the screen to enter the function navigation.
3. Then click or tap the **Upgrade** icon to perform the upgrade operation.

## 23.5 Disk Management

You can enter the storage setting menu in the following ways.

- Click or tap the function navigation icon  at the lower-left corner of the screen, and then select **Storage** to enter the storage setting menu.
- Click or tap the **Storage** button on the toolbar to enter the storage setting menu.

Then click or tap **Disk** at the lower-left corner of the "Storage" menu to enter the disk management interface, as shown in the figure below.

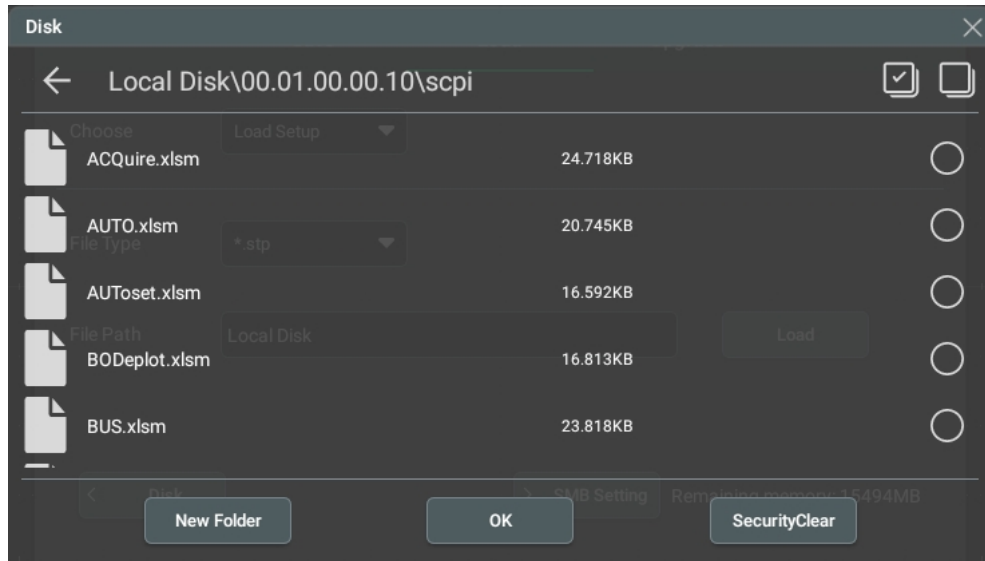

**Figure 23.6 Disk Management Interface**

In the disk management menu, you can perform the following operations:

#### Select a Disk

Before using the external storage device, make sure that a USB storage device (FAT32 format) is connected correctly.

By default, the "Local Disk(C)" is selected. After an external USB storage device (D:) or a shared folder (I:) is connected, you can select Removable USB Disk (D) or SMB (I) from the drop-down list at the upper-left corner of the "Disk" interface.

#### Create a Folder

Click or tap **New Folder**, then a folder name input keyboard is displayed.



For how to use the keypad, refer to descriptions in *Parameter Setting Method*. Click or tap any place on the screen to exit the keyboard.



#### Clear the Internal Memory Safely

Click or tap **SecurityClear**, then a prompt message "Execute secure memory wipe?" is displayed. Click or tap **OK** to clear all the files stored in the internal disk. Otherwise, click or tap **Cancel** to cancel security clear operation.

#### Select a File

Before operating on the file or folder, first select the desired file or folder.

Click or tap the check box at the right side of the folder, if checked, it is selected, with an icon  being displayed. Click or tap the check box again or  to deselect it. The check box restores its original state.

This series supports selecting multiple files or folders to operate on. You can also click or tap the icon  at the upper-right corner of the interface to select all the files and folders under the current disk. Click or tap  to cancel the select-all operation.

### Cut, Copy, or Paste a File or a Folder

- **Cut a File to a Specified Folder**

Select a specified file or folder. Click or tap **Cut** to cut the specified file or folder. Then select the destination folder. Then click or tap **Paste** to paste the specified file or folder to the destination folder.

- **Copy a File to a Specified Folder**

Select a specified file or folder. Click or tap **Copy** to copy the specified file or folder. Then select the destination folder. Then click or tap **Paste** to paste the specified file or folder to the destination folder.

### Delete a File or Folder

In the current folder, select the file or folder to be deleted. Click or tap **Delete**, then a prompt message "Are you sure to delete the file?" is displayed. Click or tap **OK** to delete the file. Otherwise, click or tap **Cancel** to cancel the deletion operation.

### Rename a File or Folder

Select a specified file or folder, then click or tap **Rename** to input a new filename or folder name with the pop-up virtual keypad. Then, the rename operation is completed.

## 23.6 SMB Configuration

In the storage setting menu, click or tap **SMB Setting** to enter the SMB setting menu. In this menu, you can configure SMB to connect the instrument to your PC and share files.

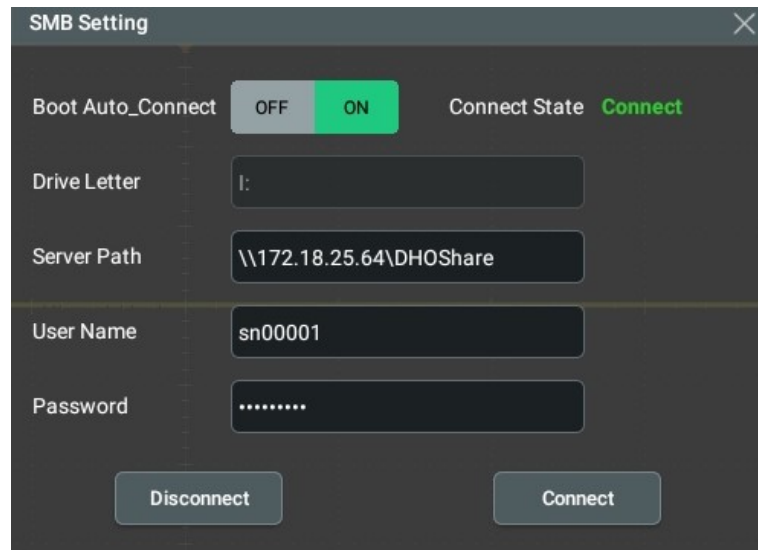

Figure 23.7 SMB Setting Menu

### Operation Procedures

Take Windows 10 Pro as an example. Follow the steps below to use SMB to share files.

1. Enable the SMB file sharing function in the computer.

a. Open the Control Panel and click **Programs and Features**.

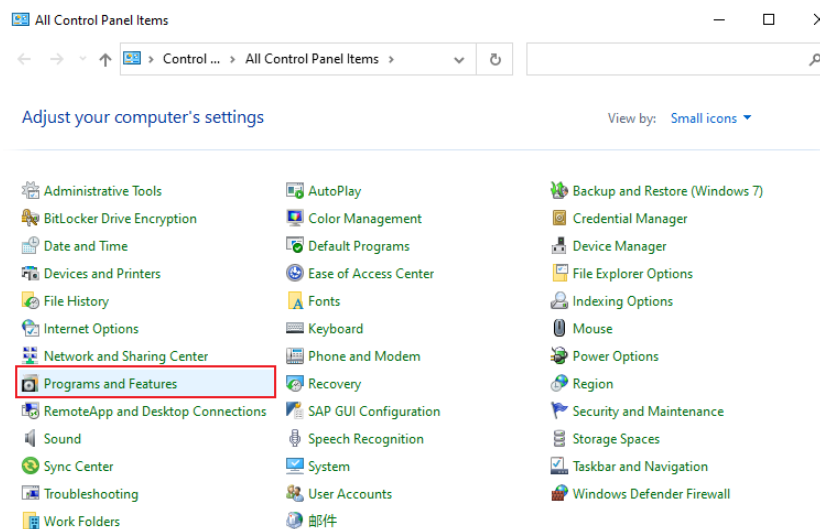

b. Click **Turn Windows features on or off**.

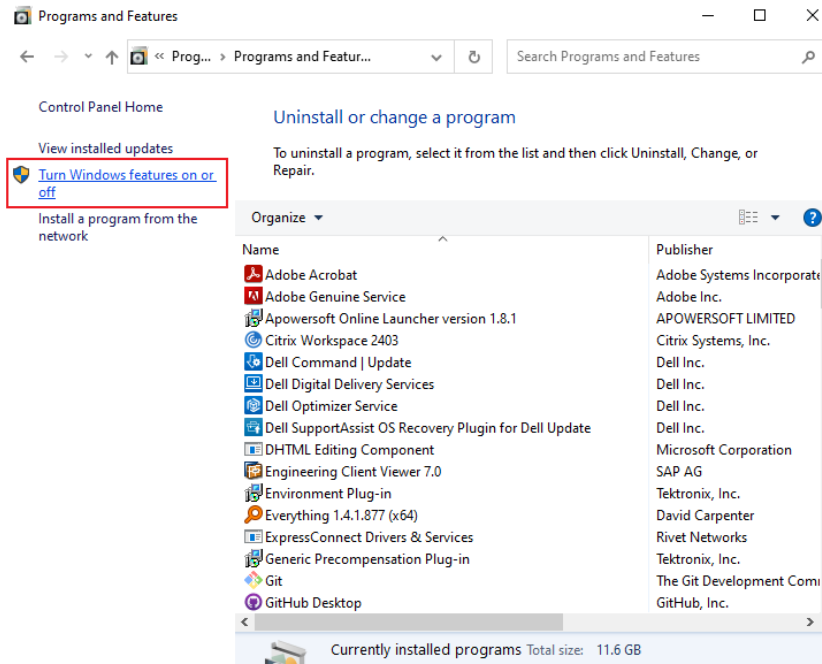

- c. In the pop-up window, find the **SMB 1.0/CIFS File Sharing Support** option. Check all the check boxes for this option and select **OK**.

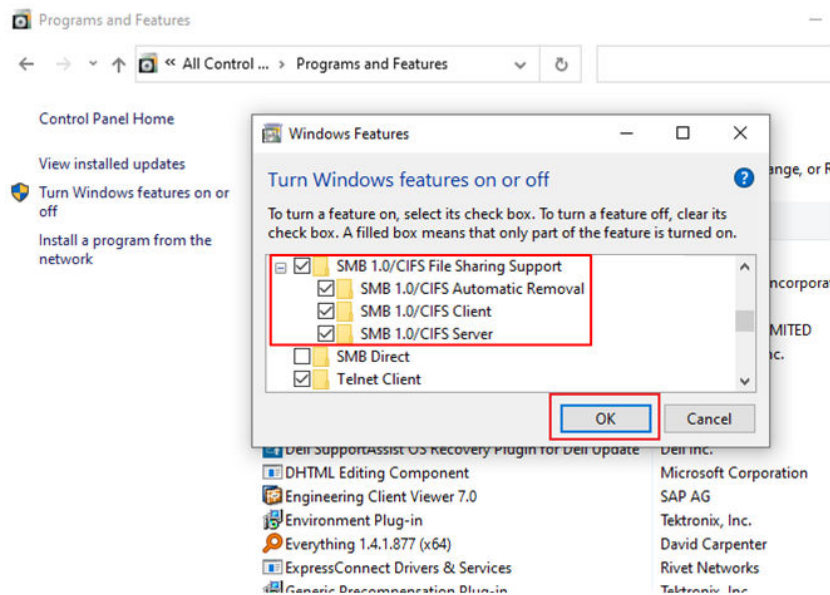

- d. Restart the computer and then the SMB file sharing function is enabled.

2. Create a shared folder.

- a. Create a new folder (containing English characters only). Right-click the folder and select **Give access to > Specific People**.

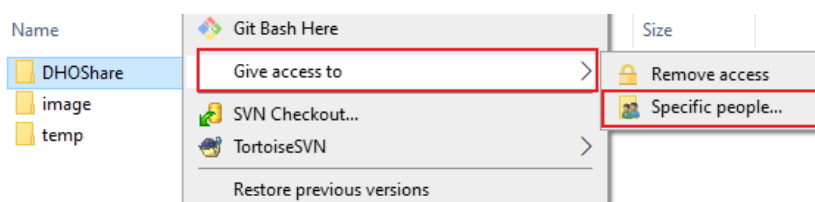

- b. In the pop-up window, select a specific user or "Everyone" and click **Add**. Then you can set the permission level.

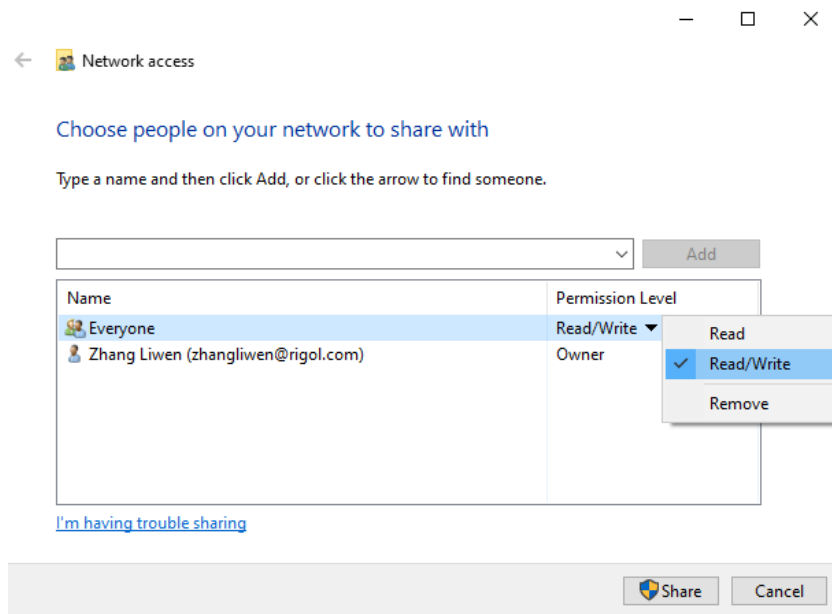

- c. Click **Share** > **Done** to complete the creation of a shared folder.

### 3. Configure the instrument.

- a. In the storage setting menu, click or tap **SMB Setting** to enter the SMB setting menu. You can set the server path, user name, and password.

#### NOTE

- The server path format is \\xxx.xxx.xxx.xxx\name, where "xxx.xxx.xxx.xxx" is the IP address and "name" is the name of the shared folder. For example, the server path can be \\172.16.25.77\DHOShare.
- You can press Windows key + R to open the Run window. Enter "netplwiz" and click **OK** to check the user account. The user name and the password are case sensitive.

- b. Click or tap **Connect** to connect the instrument to the computer. Then "Connect" is displayed for the **Connect State** item in the SMB setting menu.

You can also turn on **Boot Auto Connect**. In this case, the instrument is automatically connected to the computer according to the server path, user name, and password settings upon the next power-on.

### Share the File

After the SMB server is connected, you can access and manage the contents of the shared folder through your PC and the oscilloscope's disk management system.

The shared folder is displayed as "SMB (I)" in the oscilloscope. Click or tap the drop-down menu at the upper-left of the disk management interface to select "SMB (I)" to open the shared folder. The management method of shared files is identical to that of disk C and disk D (refer to *Disk Management*).

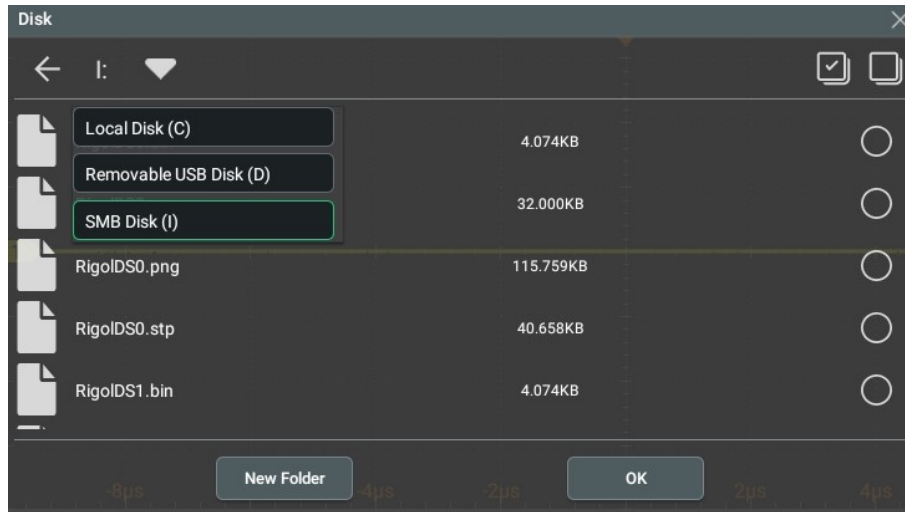

## 23.7 To Upload the File via the FTP Server

Use the USB storage device to copy the file from the PC to the local disk of the oscilloscope. You can also upload it via the FTP server to the local disk of the oscilloscope. The operation procedures are as follows:

1. Connect the oscilloscope to the network via the LAN interface. Then obtain the IP address. For example, 192.68.0.1.
2. Open the file explorer of the PC or the browser, then input "ftp://192.68.0.1/" (quotation marks not included) into the address bar to access the file manager of the oscilloscope.
3. Copy the file from the PC to the file manager of the oscilloscope. After uploading the file, you can view the file in the disk management interface of the oscilloscope.



### NOTE

When you choose to upload the file via the FTP server, note that the name of the file that you upload shall not contain any Chinese characters.

## 24 System Utility Function Setting

In the **Utility** menu, you can set the I/O parameters and the system-related function parameters. You can enter the "Utility" menu in the following ways.

- Click or tap the Notification Area at the lower-right corner of the screen. Then the **Utility** menu is displayed.
- Click or tap  > **Utility** to enter the **Utility** menu.

### 24.1 I/O Setting

In **Utility** menu, click or tap **IO** to enter the I/O setting menu to configure the following parameters.

#### Network Status

Different prompts will be displayed according to the current network connection status.

- Network Config Succeeded!
- Acquiring IP..
- IP Conflict!
- DISCONNECTED
- DHCP Config Failed
- Read Status Fail!
- CONNECTED
- Invalid IP
- IP lost
- Please wait...

#### MAC Address

For each instrument, the MAC address is unique. When assigning the IP address for the instrument, the system uses the MAC address to identify the instrument.

#### VISA Address

Displays the VISA address currently used by the instrument.

## IP Configuration Type

The configuration type of the IP address can be DHCP, Auto IP, or Static IP. In different IP configuration types, the configurations for IP address and other network parameters are different.

- **DHCP**

If "DHCP" is selected, the DHCP server in the current network will assign the network parameters (e.g. IP address, Subnet, Gateway, and DNS) for the instrument.

- **Auto IP**

When "Auto IP" is selected, the instrument will acquire the IP address ranging from "169.254.0.1" to "169.254.255.254" and the subnet mask (255.255.0.0) automatically based on the current network configuration. The "Auto IP" works only when "DHCP" is not selected or the connection failed.

- **Static IP**

If "Static IP" is selected, the instrument is configured with static IP. In this case, you need to disable DHCP and Auto IP manually. Then you need to configure the parameters such as "IP address", "Subnet", "Gateway", and "DNS" manually. At this time, you can self-define the network parameters (e.g. IP address) of the instrument.

- **Set the IP address**

The format of the IP address is nnn.nnn.nnn.nnn. The range of the first segment (nnn) of the address is from 0 to 255 (except 127); wherein, the valid range is from 0 to 223. The range for the other three segments is from 0 to 255. You are recommended to ask your network administrator for an IP address available.

This setting will be saved to the non-volatile memory; if "Load Last" is set to "Last", then DHCP and Auto IP are disabled at the next power-on. The instrument will load the preset IP address automatically.

- **Set the subnet mask**

The format of the subnet mask is nnn.nnn.nnn.nnn. Wherein, the range of "nnn" is from 0 to 255. You are recommended to ask your network administrator for a subnet mask available.

This setting will be saved in the non-volatile memory; if "Load Last" is set to "Last", then DHCP and Auto IP are disabled at the next power-on. The instrument will load the preset subnet mask automatically.

- **Set the default gateway**

You can set this parameter in Static IP mode. The format of the gateway is nnn.nnn.nnn.nnn. The range of the first segment (nnn) is from 0 to 223 (except 127), and the range for the other three segments is from 0 to 255.

You are recommended to ask your network administrator for a gateway address available.

This setting will be saved in the non-volatile memory; if "Load Last" is set to "Last", then DHCP and Auto IP are disabled at the next power-on. The instrument will load the preset gateway automatically

- **Set the DNS address**

You can set this parameter in Static IP mode. The format of the DNS address is "nnn.nnn.nnn.nnn". The range for the first segment (nnn) of the address is from 0 to 223 (except 127); and the range for the other three segments is from 0 to 255. You are recommended to ask your network administrator for an address available.

Generally, you do not need to set the DNS, so this parameter setting can be ignored.



**TIP**

- When the three IP configuration types are all turned on, the priority of the parameter configuration from high to low is "DHCP", "Auto IP", and "Static IP".
- The three IP configuration types cannot be all turned off at the same time.

**mDNS**

Click or tap the mDNS on/off switch to enable or disable the multicast Domain Name System (mDNS). This system is used to provide the function of DNS server for service discovery in a small network without a DNS server.

**Host Name**

A maximum of 26-byte strings can be supported.

**Apply the Network Parameter Setting**

Click or tap **Apply** to validate the current network parameter setting.

## 24.2 Basic Settings

In the **Utility** menu, click or tap **Setup** to enter the basic setting menu.

**Language**

This product supports menus in multiple languages, including the display of the help information, prompt messages, and interface. Click or tap the drop-down button of **Language** to select the specified system language.

**Screen Brightness**

Drag the slider to set the screen brightness. Its range is from 1% to 100%.

### Load Last

You can set the system configuration to be recalled when the oscilloscope is powered on again after power-off. Click or tap "Default" or "Last" for **Load last**.

- Last: restores the system to its last setting at last power-off.
- Default: restores the system to its factory setting.

### Power Status

- Switch Off: After the oscilloscope is connected to power, you need to press the power key on the front panel to power on the instrument.
- Switch On: After the oscilloscope is connected to power, it will be powered on immediately.

### Beeper

Click or tap the **Beeper** on/off switch to enable or disable the beeper. When the beeper is enabled, you can hear the beeper sound in the following situations:

- Use a front-panel key or a menu key
- Use the touch screen
- When a prompt message is displayed

### AUX Output

You can set the type of the signal output from the **[AUX OUT]** connector on the rear panel.

- **TrigOut:** After this type is selected, at each trigger (hardware trigger), the oscilloscope outputs a signal from the **[AUX OUT]** connector on the rear panel that can reflect the current capture rate of the oscilloscope. If this signal is connected to a waveform display device to measure the frequency, the found measurement result is the same as the current capture rate.

When the AUX Out menu is set to "TrigOut", then in the pass/fail test menu (click or tap  > **Pass/Fail** to enter the pass/fail test menu), the **Aux Output** menu item is automatically disabled.





- **PassFail:** After this type is selected, the instrument can output a positive or negative pulse via the **[AUX OUT]** connector when a successful or failed event is detected.

When the AUX Out menu is set to "PassFail", then in the pass/fail test menu (click or tap  > **Pass/Fail** to enter the pass/fail test menu), the **Aux Output** menu item is automatically enabled. For the parameter settings such as pulse width, polarity, and output event of the pulse signal output from the connector,

you can set it in the "Option" menu of the "PassFail" interface. For details, refer to *To Set the Output Form of the Test Results*.

### Input Lock

When enabled, the input operation is disabled. Both the touch screen operation and the front-panel keys except the Power key are disabled. You cannot operate with the touch screen and front-panel keys and knobs.

To unlock the operation, press the front-panel channel keys CH1 , CH1 , CH2 , CH2  in sequence to unlock the operation.

### Expand

The waveform display can be set to expand or compress about the "Center" or "GND".

- **Center:** When the vertical scale is changed, the displayed waveform will expand or compress about the center of the display.
- **GND:** When the vertical scale is changed, the displayed waveform will expand or compress about the ground level position of the signal.

### Vernier/Zoom

It sets the effect of pressing the front-panel **Horizontal**  **SCALE** knob.

- **Vernier:** enables or disables the fine adjustment when the knob is pressed.
- **Zoom:** enables or disables the Zoom mode when the knob is pressed.

### Display Time

Click or tap the ON/OFF tab for the **Display Time** menu to enable or disable the display of the system time. When enabled, the system time (date and time) is displayed in the Notification Area at the lower-right corner of the screen. The date is displayed in "yyyy/mm/dd" format, and the time is displayed in "hh:mm:ss" format. You can enable or disable the display of system time when saving the waveform. When enabled, the saved file will contain the system time information.

- **Date:** Click or tap the "Date" area, then the date setting interface is displayed. Drag the year, month, and day section up and down respectively to set the date. Click or tap **OK** to confirm the date modification. Click or tap the close window icon  to cancel the date modification and exit the menu. You can also click or tap any place other than the date setting interface to exit the date modification menu.
- **Time:** Click or tap the "Time" area, then the time setting interface is displayed. Drag the hour and minute section up and down respectively to set the time.

Click or tap **OK** to confirm the time modification. Click or tap the close window icon  to cancel the time modification and exit the menu. You can also click or tap any place other than the time setting interface to exit the time modification.

## 24.3 About this Oscilloscope

In **Utility** menu, click or tap **About**, and then you can view the model, version, and other information about this instrument in **About** menu.

- **Model**  
Indicates the product model.
- **Serial Number**  
Indicates the serial number, the unique identification for the product.
- **Firmware**  
Indicates the firmware version number of the product.
- **Hardware**  
Indicates the hardware version number of the product.
- **Build**  
Indicates the creation time of the software version.
- **Android.Build**  
Indicates the creation time of the Android operating system.
- **Android.Version**  
Indicates the version number of the Android operating system. For example, 7.1.0.
- **Launcher**  
Indicates the desktop UI version number of the Android operating system.
- **WebControl**  
Indicates the version number of browser remote control module.
- **Open Source Acknowledgment**  
Indicates the open source software acknowledgment for the oscilloscope.

## 24.4 Auto Config

In "Utility" menu, click or tap **Auto Config** to enter the menu in which you can configure the **Auto** function.

- Click or tap **Peak to Peak** on/off switch to enable or disable the peak-to-peak priority setting. This function is intended for the shifted signal. If there is a large deviation, you can view the signal waveform in priority when you enable the function.
- Click or tap **Live CH** on/off switch to turn on/off examining channels that are turned on.  

If "OFF" is selected, enable the Auto function and 4 analog channels (CH1-CH4) will be examined for signal activity in sequence. If no signal is detected for a specified channel, the channel will be turned off; otherwise, if a signal is detected, the channel will be autoscaled to best display the signal. If "ON" is selected, enable the Auto function and only the channels that are turned on will be examined.
- Click or tap **Overlay** on/off switch to enable or disable the waveform overlay display function. If enabled, waveforms of different channels will be displayed in the same position of the screen; if disabled, waveforms of different channels will be displayed on the screen from top to bottom in sequence.
- Click or tap **Keep Coupling** on/off switch to turn on/off maintaining channel coupling. If "ON" is selected, enable the Auto function and the channel coupling setting is maintained; if "OFF" is selected, the channel coupling is DC coupling by default.

## 24.5 SelfCal

The self-calibration program can quickly make the oscilloscope to work in an optimal state to get the precise measurement results. You can perform self-calibration at any time, especially when the changes of the ambient temperature reach or exceed 5°C. Make sure that the oscilloscope has been warmed up or operating for more than 30 minutes before the self-calibration.

In "Utility" menu, click or tap **SelfCal**, the self-calibration menu is as shown below.

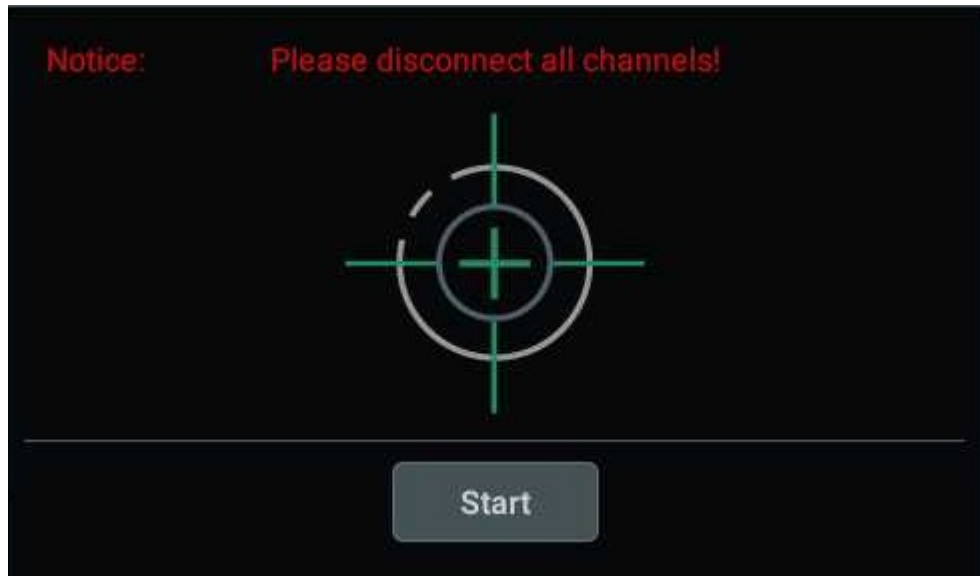

Figure 24.1 Self-calibration Menu

- Click or tap **Start**, and then the oscilloscope will start to execute the self-calibration program.
- After starting the self-calibration program, click or tap **Exit** to cancel self-calibration operation at any time.
- Click or tap **Close** to close the self-calibration information window.

## 24.6 Option List

In the "Utility" menu, click or tap **Options** to view all the options of the instrument.

## 24.7 Quick Operation

In the **Utility** menu, click or tap **Quick Settings** to enter the quick setting operation menu.

### Save Image

- Click or tap **Save Image**, and the current **Operation** menu shows "Save Image".
- In the **Format** menu item, the available image type can be **".\*png"**, **".\*bmp"**, or **".\*jpg"**.
- Click or tap the ON/OFF tab for **Invert** to enable or disable the invert function.
- Click or tap **"Color"** or **"Gray"** for **Color** to select the desired storage color.

After setup, click or tap the  key at the upper-right corner of the front panel to capture the current screen and save the image with the specified format. The location where the file is saved depends on the **File Path** setting in Storage menu. For details, please refer to *To Save a File*.

### Save Wave

- Click or tap **Save Wave**, and the current **Operation** menu shows "Save Wave".
- Click or tap to select "**Memory**", "**Screen**", or "**Record**" (only available when Record function is enabled and recorded waveforms are available) under **Data Source** as the source of waveforms to be saved.
- The available choices under **Format** include "\*.bin" and "\*.csv". Recorded waveforms can only be saved in "\*.csv" format.

After configuring the settings, press  on the front panel to capture the current waveform and save it based on your settings of the waveforms to be saved. The location where the file is saved depends on the **File Path** setting in Storage menu. For details, please refer to *To Save a File*.

### Save Setup

Click or tap **Save Setup**, and the current **Operation** menu shows "Save Setup".

After configuring the settings, press  on the front panel to save the current settings of the oscilloscope as a file suffixed with "\*.stp". The location where the file is saved depends on the **File Path** setting in Storage menu. For details, please refer to *To Save a File*.

### All Measurements

- Click or tap **All Measure**, and the current **Operation** menu shows "All Measure".
- The available channels under **All Measure** are CH1-CH4.

After setup, click or tap the  key at the upper-right corner of the front panel to perform the measurement on the specified channel.

### Reset Statistics

- Click or tap **Stat Reset**, and the current Operation menu shows "Stat Reset".
- Under **Stat Reset**, click or tap "Measure" or "Pass/Fail" to reset the statistics of the specified function.

After configuring the settings, press  on the front panel to reset the result list of the specified function. Then the instrument restarts to make statistics.

### Record Waveforms

Click or tap **Record**, and the current **Operation** menu shows "Record".

After configuring the settings, press  on the front panel to record the waveforms.

### Save Group

- Click or tap **Save Group**, and the current **Operation** menu shows "Save Group".
- Under **Save Group**, select one or multiple items from "**Save Image**", "**Save Wave**", and "**Save Setup**".

After configuring the settings, press  on the front panel to save the specified type based on your choice. The location where the file is saved depends on the **File Path** setting in Storage menu. For details, please refer to *To Save a File*.

### Full Screen

Click or tap **Screen Change**, and the current **Operation** menu shows "Screen Change".

After setup, click or tap the  key at the upper-right corner of the front panel to switch the waveform view to the full-screen display mode.

## 24.8 Self-check

In the **Utility** menu, click or tap **Self Check** to enter the sub-menus of "Self Check". You can test the following self-check items for the device.

### Key Test

Click or tap **Key Test** to enter the key test interface (virtual front-panel key).

At this time, you can press the keys on the front panel to check whether the virtual keys are highlighted. If yes, it indicates that the keys work normally; if no, it indicates that there's something wrong with the keys. If the virtual key is not illuminated, the key may fail to work. Click or tap **Exit** at the lower-left corner of the interface to exit the key test interface.

### Touch Test

Click or tap **Touch Test** to enter the touch screen test interface.

Slide with your finger on the screen. If there is a line displaying at the empty area where you slide on the screen and the box that you tap turns out to be filled with green background, it indicates that the touch function of this area is normal. Click or tap **Exit** at the lower-left corner of the interface to exit the touch screen test interface.

### Screen Test

Click or tap **Screen Test** to enter the screen test interface and check whether the defective pixel exists.

There are 15 screen test interfaces. Click or tap the screen to switch to the next screen test interface. Click or tap **Exit** at the upper-left corner of the interface to exit the screen test interface.

## 25 Remote Control

The following ways of remote control are supported:

- **User-defined Programming**

Users can program and control the instrument by using the SCPI (Standard Commands for Programmable Instruments) commands. For details about the SCPI commands and programming, refer to Programming Guide of this product series.

- **Web Control**

The instrument supports the Web Control function. Web Control is a browser-based remote control technology that allows the user to remotely access and control the instrument over the network without additional software installation. By using the web browser to remotely access the networked instrument, the control terminals (e.g. PC, Mobile, iPad, and other smart terminals) display the instrument interface in real time. Users can view device information, adjust the oscilloscope's timebase and vertical sensitivity, configure trigger conditions, and more. Operation Procedures are as follows:

1. Connect the instrument to the network

First ensure that the rear-panel LAN interface is connected to the network. Note that the instrument must be connected to and accessed through the network that located in the same network domain as the control terminal.

2. Obtain the instrument IP address

Click or tap the function navigation icon  at the lower-left of the screen. Click or tap **Utility**, and view the instrument IP address under the IO menu.

3. Type the instrument IP address into the browser address bar and press Enter, and the following interface will be displayed.

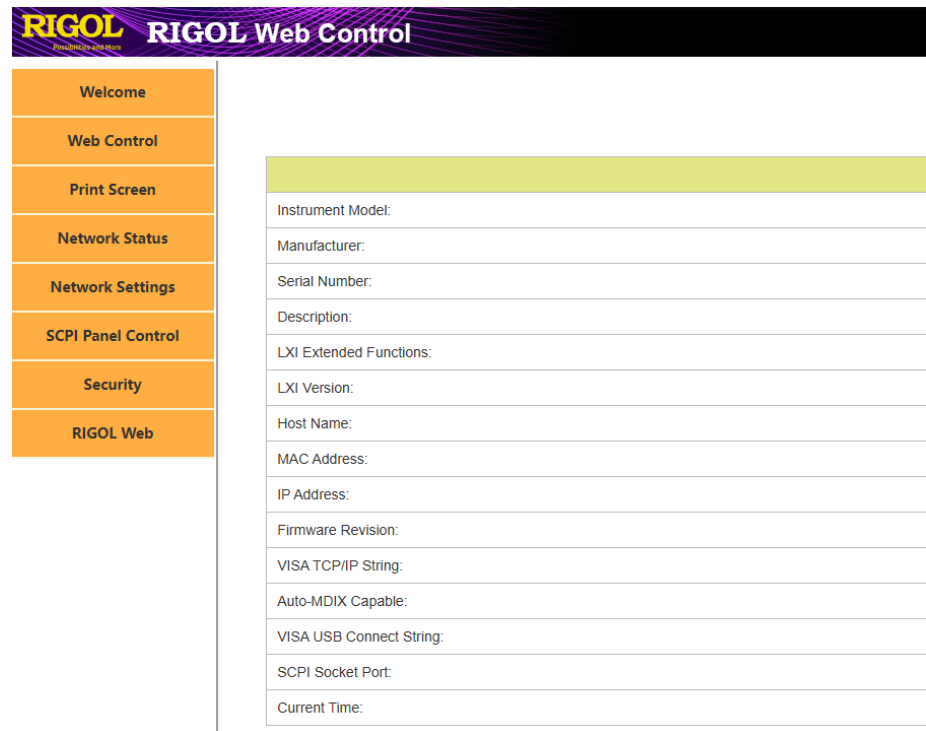

4. Click **Web Control** on the left side of the screen to enter the instrument remote control interface. You can use the mouse to remotely control the instrument in real time, with the same effect as operating the instrument directly.
5. Click **Print Screen**, and you can select "Take Screenshot" or "Record Screen" to capture the current display content.
6. Click **Network Settings** to configure the network. Note that login is required when changing the network configuration. The default username and password for first-time Web Control login are "admin" and "rigol".
7. The SCPI Panel Control function allows the user to send SCPI commands through the web interface for remote programming control of the instrument. Click **SCPI Panel Control** and enter the commands in the SCPI Command input field. After entering the commands, click the **Send&Read** button to control the instrument remotely. For details about the SCPI commands and programming, refer to Programming Guide of this product series.
8. Close the browser to exit the instrument remote control interface.

The instrument IP address allows only one user to log in for remote login control. Concurrent logins are not allowed. If the connection is interrupted, you can refresh the browser to load the page.

**CAUTION**

**Before connecting the communication cable, please turn off the instrument to avoid causing damage to the communication interfaces.**

## 26 Troubleshooting

---

### **1. When I power on the instrument, the instrument's screen stays black and does not display anything.**

- a. Check whether the power supply has been connected correctly.
- b. Check whether the power key is really pressed.
- c. Restart the instrument after finishing the above inspections.
- d. If the problem still persists, please contact RIGOL.

### **2. No waveform of the signal is displayed on the screen.**

- a. Check whether the probe is properly connected to the item under test.
- b. Check whether there are signals generated from the item to be tested (you can connect the probe compensation output signal to the faulty channel to locate the problem, and then determine whether the channel or the item to be tested has a problem).
- c. Resample the signal.
- d. If the problem still persists, please contact RIGOL.

### **3. The USB storage device cannot be recognized.**

- a. Check whether the USB storage device can work normally when connected to other instruments or PC.
- b. Make sure that the USB storage device is FAT32 format. The instrument doesn't support hardware USB storage device.
- c. After restarting the instrument, insert the USB storage device again to check whether it can work normally.
- d. If the USB storage device still cannot work normally, please contact RIGOL.

### **4. The touch-enabled operation does not work.**

- a. Check whether you have locked the touch screen. If yes, unlock the touch screen.
- b. Check whether the screen or your finger is stained with oil or sweat. If yes, please clean the screen or dry your hands.
- c. Check whether there is a strong magnetic field around the instrument. If the instrument is close to the strong magnetic field (e.g. a magnet), please move the instrument away from the magnet field.
- d. If the problem still persists, please contact RIGOL.

## 27 Appendix

### 27.1 Appendix A: Options and Accessories

Order Information	Order No.
<b>Model</b>	
800 MHz, 4 GSa/s, 100 Mpts, 4-CH digital oscilloscope	MHO984
500 MHz, 4 GSa/s, 100 Mpts, 4-CH digital oscilloscope	MHO954
350 MHz, 4 GSa/s, 100 Mpts, 4-CH digital oscilloscope	MHO934
<b>Standard Accessory</b>	
Power Adapter Conforming to the Standard of the Destination Country	— —
Ground Cable	— —
USB Cable	— —
4 Passive Probes (350 MHz) (Standard Configuration for MHO934)	PVP2350
4 Passive Probes (500 MHz) (Standard Configuration for MHO984 and MHO954)	RP3500A
<b>Performance Upgrade Option</b>	
500 Mpts Memory Depth Option	MHO900-RLU-05
350 MHz-500 MHz Bandwidth Upgrade Option	MHO900-BWU03T05
350 MHz-800 MHz Bandwidth Upgrade Option	MHO900-BWU03T08
500 MHz-800 MHz Bandwidth Upgrade Option	MHO900-BWU05T08
<b>Function Upgrade Option</b>	
50 MHz Function/Arbitrary Waveform Generator (AFG) option (Bode plot supported)	MHO900-AFG50
100 MHz Function/Arbitrary Waveform Generator (AFG) option (Bode plot supported)	MHO900-AFG100
Audio Serial Bus Trigger and Analysis Option	MHO900-AUDIOA

Order Information	Order No.
CAN Serial Bus Analysis with Flexible Data Rate	MHO900-AUTOA
FlexRay Serial Bus Trigger and Analysis Option	MHO900-FlexA
MIL-STD-1553 Bus Trigger and Analysis Option	MHO900-AEROA
Function and Application Bundle Options, including AFG100, AUDIOA, AUTOA, FlexA, and AEROA.	MHO900-BND
Recommended Accessories	
16-channel Logic Analyzer Probe	PLA2216
Portable Instrument Bag	BAG-800

**NOTE**

For all the mainframes, accessories, and options, please contact the local office of RIGOL.

## 27.2 Appendix B: Warranty

RIGOL TECHNOLOGIES CO., LTD. (hereinafter referred to as RIGOL) warrants that the product mainframe and product accessories will be free from defects in materials and workmanship within the warranty period. If a product proves defective within the warranty period, RIGOL guarantees free replacement or repair for the defective product.

To get repair service, please contact your nearest RIGOL sales or service office.

There is no other warranty, expressed or implied, except such as is expressly set forth herein or other applicable warranty card. There is no implied warranty of merchantability or fitness for a particular purpose. Under no circumstances shall RIGOL be liable for any consequential, indirect, ensuing, or special damages for any breach of warranty in any case.

## 27.3 Appendix C: Factory Settings





Press the front-panel  or click/tap **Default** on the Toolbar and a prompt message "Restore default settings?" is displayed. Click or tap **OK** to restore the instrument to its factory default settings, as shown in the table below.

Table 27.2 Factory Settings

Parameter	Factory Settings
<b>Horizontal</b>	
Scale	2 $\mu$ s
Position	0 s
Delayed Sweep	OFF
Roll	Auto
Vernier	OFF
Expand	Center
<b>Acquire</b>	
Acquisition Mode	Normal
Memory Depth	10 kpts
<b>Vertical</b>	
CH1 On/Off	ON
CH2 On/Off	OFF
CH3 On/Off	OFF
CH4 On/Off	OFF
Impedance	1 M $\Omega$
Vernier	OFF
Vertical Scale	50 mV
Vertical Offset	0 V
Channel Unit	[V]
Channel Coupling	DC
Bias	0V
Bandwidth Limit	OFF
Ch-Ch Skew	0 s
Display Label	OFF
Invert	OFF
Probe Ratio	1X
<b>Trigger</b>	
Trigger Type	Edge Trigger
Sweep	Auto
Source	CH1
Slope	Rising
Trigger Coupling	DC
Trigger Holdoff	8 ns
Noise Reject	OFF
<b>Display</b>	

Parameter	Factory Settings
Display Type	Vector
Persistence Time	Min
Wave Intensity	100%
Grid	FULL
Grid Brightness	50%
Window Transparency	50%
Cursor Brightness	80%
Show Scale	ON
Color Grade	OFF
Waveform Freeze	ON
Move Scale	OFF
<b>Measure</b>	
Threshold	OFF
Indicator	OFF
Histogram	OFF
Statistic	OFF
Count	1,000
Display Type	%
Source	CH1
Upper	90%
Mid	50%
Lower	10%
Amp Method	Auto
UpdateAllSRC	CH1
Region	Main
<b>Cursor</b>	
Mode	OFF
<b>Manual</b>	
Source	CH1
Select	X
AX BX	OFF
AY	-6 $\mu$ s
BY	6 $\mu$ s
<b>Track</b>	
AX Source	CH1
BX Source	CH1
AX BX	OFF
Track	X
AX	-6 $\mu$ s
BX	6 $\mu$ s

Parameter	Factory Settings
<b>XY</b>	
Select	X
AX BX	OFF
AX	-150 mV
BX	150 mV
<b>Frequency Counter</b>	
Source	CH1
Statistic	OFF
Measure	Frequency
Resolution	4
<b>DVM</b>	
Source	CH1
Mode	AC RMS
Beeper	OFF
When	In Limits
Upper	1 V
Lower	0 V
<b>Save Image</b>	
Format	*.png
Invert	OFF
Color	Color
Header	ON
Overlay	OFF
<b>Save Wave</b>	
Data source	Screen
Format	*.bin
<b>Save Setup</b>	
File Type	*.stp
<b>Load Setup</b>	
File Type	*.stp
<b>System Setting</b>	
Beeper	OFF
AUX Out	TrigOut
Operation Lock	OFF
Expand	GND
Vernier/Zoom	Vernier

Parameter	Factory Settings
<b>Auto Config</b>	
Peak to Peak	ON
Live CH	OFF
Overlay	ON
Coupling	OFF
<b>Quick Settings</b>	
Operation	Save Image
Format	*.png
Invert	OFF
Color	Color
<b>Pass/Fail Test</b>	
Enable	OFF
Source	CH1
Y Mask	480 mdiv
X Mask	240 mdiv
Format (to load file)	*.pf
Format (to save file)	*.pf
File Name	RigolDS
Aux Output	OFF
Pulse	1 $\mu$ s
Output Event	Fail
Polarity	Positive
Error Action	Stop
<b>Waveform Recording</b>	
Enable	OFF
<b>Record</b>	
Interval	10 ns
Frames	1,000
Beeper	
<b>Play</b>	
Minimize	OFF
Play Mode	
Play Sequence	
Interval	100 ms
<b>Math Operation</b>	
Invert	OFF
Expand	GND

Parameter	Factory Settings
Display Label	OFF
Grid	FULL
Display Area	Math
<b>A+B</b>	
Operation	OFF
Source A	CH1
Source B	CH1
Scale	500 mV
Offset	0 V
<b>A-B</b>	
Operation	OFF
Source A	CH1
Source B	CH1
Scale	500 mV
Offset	0 V
<b>A×B</b>	
Operation	OFF
Source A	CH1
Source B	CH1
Scale	500 mU
Offset	0 U
<b>A÷B</b>	
Operation	OFF
Source A	CH1
Source B	CH1
Scale	500 mU
Offset	0 U
<b>FFT</b>	
Operation	OFF
Source	CH1
X	Span-Center
Unit	dBm/dBV
Center Frequency	5 MHz
Span	10 MHz
Vertical Scale	20 dB
Offset	0 dBV
Window Function	Hanning
Color Grade	OFF
Peak Search	OFF
Peak Number	5
Threshold	5.5 dBV

Parameter	Factory Settings
Threshold	1.8 dB
Order	Amp Order
<b>A&amp;&amp;B</b>	
Operation	OFF
Source A	CH1
Source B	CH1
Waveform Size	Medium
Offset	0 div
Sensitivity	300 mdiv
Thre.CH1	0 V
Thre.CH2	0 V
Thre.CH3	0 V
Thre.CH4	0 V
<b>A  B</b>	
Operation	OFF
Source A	CH1
Source B	CH1
Waveform Size	Medium
Offset	0 div
Sensitivity	300 mdiv
Thre.CH1	0 V
Thre.CH2	0 V
Thre.CH3	0 V
Thre.CH4	0 V
<b>A^B</b>	
Operation	OFF
Source A	CH1
Source B	CH1
Waveform Size	Medium
Offset	0 div
Sensitivity	300 mdiv
Thre.CH1	0 V
Thre.CH2	0 V
Thre.CH3	0 V
Thre.CH4	0 V
<b>!A</b>	
Operation	OFF
Source A	CH1
Waveform Size	Medium
Offset	0 div
Sensitivity	300 mdiv

Parameter	Factory Settings
Thre.CH1	0 V
Thre.CH2	0 V
Thre.CH3	0 V
Thre.CH4	0 V
<b>Intg</b>	
Operation	OFF
Source	CH1
Scale	500 mV*s
Offset	0 V*s
Bias	0 V
<b>Diff</b>	
Operation	OFF
Source	CH1
Scale	500 mV/s
Offset	0 V/s
Smooth	5
<b>Sqrt</b>	
Operation	OFF
Source	CH1
Scale	500 mU
Offset	0 U
<b>Lg</b>	
Operation	OFF
Source	CH1
Scale	500 mU
Offset	0 U
<b>Ln</b>	
Operation	OFF
Source	CH1
Scale	500 mU
Offset	0 U
<b>Exp</b>	
Operation	OFF
Source	CH1
Scale	500 mU
Offset	0 U
<b>Abs</b>	
Operation	OFF
Source	CH1
Scale	500 mV
Offset	0 V

Parameter	Factory Settings
<b>Low Pass</b>	
Operation	OFF
Source	CH1
Scale	500 mV
Offset	0 V
$\omega c$	20 MHz
<b>High Pass</b>	
Operation	OFF
Source	CH1
Scale	500 mV
Offset	0 V
$\omega c$	20 MHz
<b>Band Pass</b>	
Operation	OFF
Source	CH1
Scale	500 mV
Offset	0 V
$\omega c1$	20 MHz
$\omega c2$	40 MHz
<b>Band Stop</b>	
Operation	OFF
Source	CH1
Scale	500 mV
Offset	0 V
$\omega c1$	20 MHz
$\omega c2$	40 MHz
<b>AX+B</b>	
Operation	OFF
Source	CH1
Scale	500 mV
Offset	0 V
A	1
B	0
<b>Ref</b>	
Current	Ref1
Source	CH1
Vertical Scale	50 mV
Vertical Offset	0 V
Label	REF1
Label Display	OFF
Color	Orange

Parameter	Factory Settings
<b>Decode</b>	
Bus Type	Parallel
Bus Status	OFF
Format	Hex
Label	ON
Event Table	OFF
<b>Parallel</b>	
CLK	OFF
Bus	CH1
Threshold	0 V
Endian	Invert
Polarity	Positive
<b>RS232</b>	
TX	CH1
RX	OFF
Threshold	0 V
Polarity	Positive
Baud Rate	9.6 kbps
Data	8 bits
Endian	LSB
Parity	None
Stop Bit	1 bit
<b>I2C</b>	
CLK	CH1
SCL Thre	0 V
Data	CH2
SDA Thre	0 V
Exchange	SCL/SDA
<b>SPI</b>	
CLK	CH1
CLK Threshold	0 V
Edge Type	Falling Edge
MISO	CH2
MISO Threshold	0 V
MOSI	OFF
Mode	CS
CS	CH3
CS Threshold	0 V
CS Polarity	Negative
Polarity	Positive
Width	8

Parameter	Factory Settings
Endian	MSB
<b>LIN</b>	
Source	CH1
Threshold	0 V
Baud Rate	9.6 kbps
Parity	Without
Version	Both
<b>CAN</b>	
Source	CH1
Threshold	0 V
Signal Type	CAN_H
Baud	1 Mbps
Sample Position	50%
<b>FlexRay</b>	
Source	CH1
Threshold	0 V
Channel Selection	A
Baud Rate	10 Mbps
Signal Type	BP
Sample Position	50%
<b>I2S</b>	
SCLK	CH1
Threshold	0 V
CLK Edge	Rising
WS	CH2
Threshold	0 V
Word Size	4
Receive	4
Alignment	I2S
WS Low	Left
Endian	MSB
Data Polarity	Positive
<b>1553B</b>	
Data	CH1
Threshold	0 V
<b>LA</b>	
D0-D7	OFF
D8-D15	OFF

Parameter	Factory Settings
D0-D7 Threshold	0 V
D8-D15 Threshold	0 V
Size	Medium
Arrange	D15-D0
Enable	ON
<b>Function/Arbitrary Waveform Generator</b>	
Output	OFF
Waveform Type	Sine
Freq	1 kHz
Amp	5V
Offset	0 V
Phase	0°
Output Impedance	HighZ
<b>Bode Plots</b>	
Bode Plots	OFF
Run Status	Stop
In	CH1
Out	CH2
AFG Chan	AFG1
Impedance	HighZ
Gain Curve	ON
Phase Curve	ON
Sweep Type	Log
Disp Type	Curve
Start Freq	100 Hz
Stop Freq	1 MHz
Points	10
Amp	200 mV
Var.Amp.	OFF
<b>Histogram Analysis</b>	
Enable	OFF
Type	Horizontal
Source	CH1
Height	2 div
Left Limit	-10 ns
Right Limit	10 ns
Top Limit	200 mV
Bottom Limit	-100 mV

# Boost Smart World and Technology Innovation

Industrial Intelligent  
Manufacturing



Semiconductors

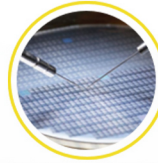

Education &  
Research

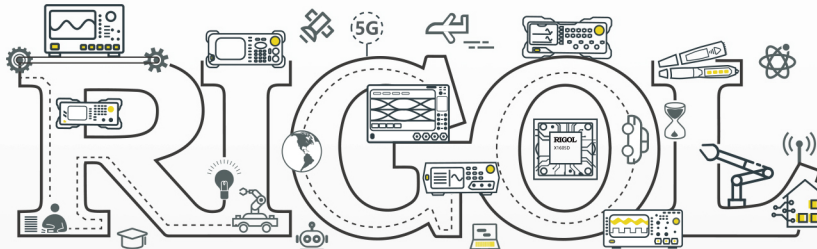

Communication

System Integration



New Energy



- 5G Cellular-5G/WIFI
- UWB/RFID/ ZIGBEE
- Digital Bus/Ethernet
- Optical Communication

- Digital/Analog/RF Chip
- Memory and MCU Chip
- Third-Generation Semiconductor
- Solar Photovoltaic Cells

- New Energy Automobile
- PV/Inverter
- Power Test
- Automotive Electronics

Provide Testing and Measuring Products  
and Solutions for Industry Customers

## HEADQUARTER

**RIGOL TECHNOLOGIES CO., LTD.**  
No.8 Keling Road, New District,  
Suzhou, JiangSu, P.R.China  
Tel: +86-400620002  
Email: info-cn@rigol.com

## JAPAN

**RIGOL JAPAN CO., LTD.**  
5F, 3-45-6, Minamiotsuka, Toshima-Ku,  
Tokyo, 170-0005, Japan  
Tel: +81-3-6262-8932  
Fax: +81-3-6262-8933  
Email: info.jp@rigol.com

## EUROPE

**RIGOL TECHNOLOGIES EU GmbH**  
Friedrichshafener Str. 5  
82205 Gilching  
Germany  
Tel: +49(0)8105-27292-21  
Email: info-europe@rigol.com

## KOREA

**RIGOL KOREA CO., LTD.**  
5F, 222, Gonghang-daero,  
Gangseo-gu, Seoul, Republic of Korea  
Tel: +82-2-6953-4466  
Fax: +82-2-6953-4422  
Email: info.kr@rigol.com

## NORTH AMERICA

**RIGOL TECHNOLOGIES, USA INC.**  
10220 SW Nimbus Ave.  
Suite K-7  
Portland, OR 97223  
Tel: +1-877-4-RIGOL-1  
Email: sales@rigol.com

## For Assistance in Other Countries

Email: info.int@rigol.com